

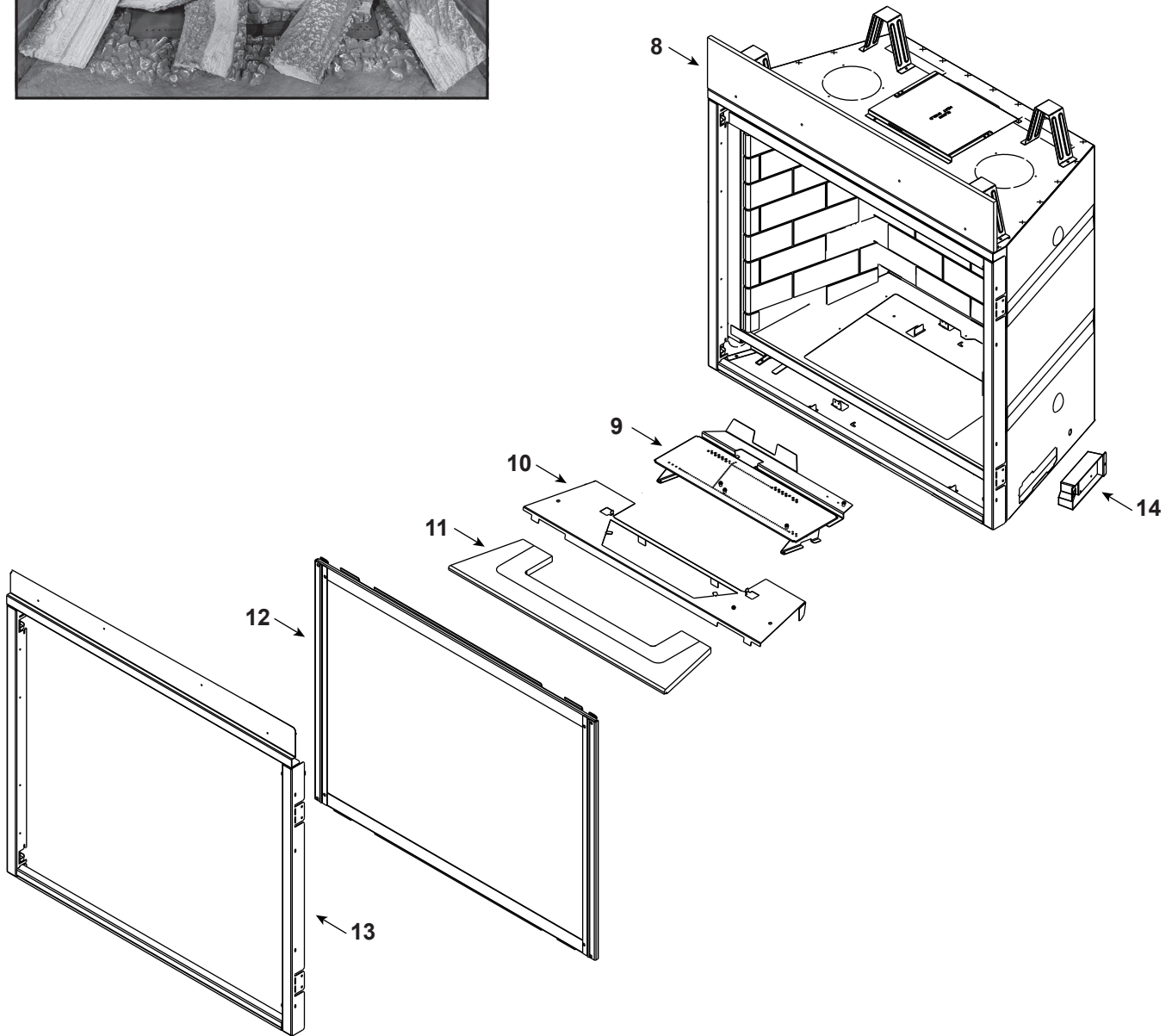

Log Set Assembly



Part number list on following page.



IMPORTANT: THIS IS DATED INFORMATION. Parts must be ordered from a dealer or distributor. **Hearth and Home Technologies does not sell directly to consumers.** Provide model number and serial number when requesting service parts from your dealer or distributor.



Stocked at Depot

ITEM	DESCRIPTION	COMMENTS	PART NUMBER
------	-------------	----------	-------------

#15 Valve Assembly

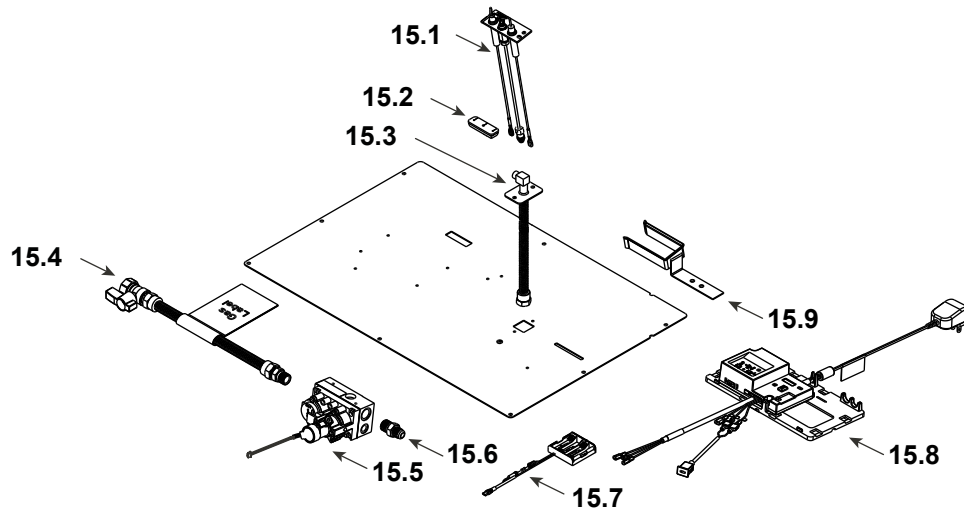

15.1	Pilot Assembly	NG	2106-169	Y
		Propane	2106-170	Y
	Pilot Tube		SRV485-301	Y
15.2	3-Hole Grommet		SRV2118-420	
15.3	Bulkhead W/Flex tube		SRV7000-156	Y
15.4	Flex Ball Valve Assembly		SRV303-330	Y
15.5	Valve	NG	SRV2166-302	Y
		Propane	2166-303	Y
15.6	Male Connector	Pkg of 5	303-315/5	Y
15.7	Battery Holder**		SRV2326-142	Y
15.8	Component Tray Assembly		See following page	
15.9	Shutter Assembly		2583-011	
	Orifice, NG (#37C)		582-837	Y
	Orifice, Propane (#52C)		SRV582-852	Y

**Fuse for battery pack can be sourced locally, not a warranty item. Specs are 250v, 3A fuse, 3/4" long
Additional service part numbers appear on following page.



Service Parts

MER36L, MER36N

Beginning Manufacturing Date: Jun 2023
Ending Manufacturing Date: Active

IMPORTANT: THIS IS DATED INFORMATION. Parts must be ordered from a dealer or distributor. **Hearth and Home Technologies does not sell directly to consumers.** Provide model number and serial number when requesting service parts from your dealer or distributor.



**Stocked
at Depot**

ITEM	DESCRIPTION	COMMENTS	PART NUMBER	
15.8a	Module, IFT Control		SRV2326-130	Y
15.8b	Harness, IFT 6 Pin Wiring		SRV2583-063	Y
15.8c	Component Tray		2279-185	
15.8d	Thermostat Wire Assembly		SRV2118-170	Y
15.8e	Transformer, 6 Volt Wall		SRV2326-131	Y
	RC400 Remote		SRV2326-110	Y
	Touch Up Paint		TUP-GBK-12	
Conversion Kits				
	Conversion Kit NG		NGK-MID	Y
	Conversion Kit Propane		LPK-MID	Y
	Pilot Orifice, NG		SRV593-528	Y
	Pilot Orifice, Propane		SRV593-527	Y
	Regulator, NG		NGK-DXV-50	Y
	Regulator, Propane		SRVLPK-DXV-50	Y