

Owner's Manual

Operation & Care

INSTALLER: Leave this manual with party responsible for use and operation.
OWNER: Retain this manual for future reference.

Contact your dealer with questions on installation, operation, or service.

NOTICE: DO NOT DISCARD THIS MANUAL

QUADRA-FIRE®

CASTILE PELLET INSERT APPLIANCE

MODEL(S):
CASTILEI-MBK
CASTILEI-PMH
CASTILEI-CSB

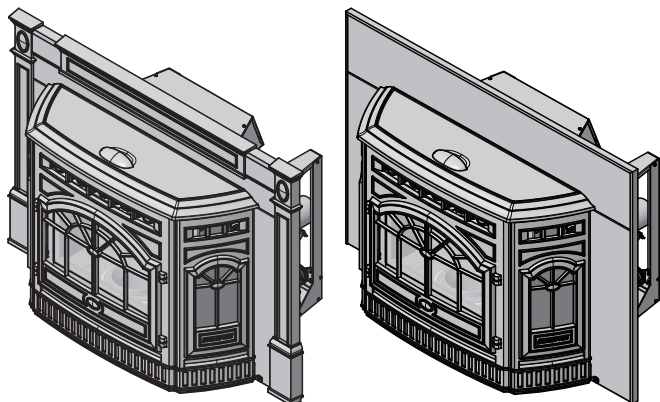

This appliance has been retired.
Service parts pages within have been removed.
For replacement parts, please refer to the individual
service parts list located on the brand websites.

! WARNING



If the information in these instructions is not followed exactly, a fire could result causing property damage, personal injury, or death.

- Do not store or use gasoline or other flammable vapors and liquids in the vicinity of this or any other appliance.
- Do not over fire - If appliance or chimney connector glows, you are over firing. Over firing will void your warranty.
- Comply with all minimum clearances to combustibles as specified. Failure to comply may cause house fire.

! WARNING



HOT SURFACES!
Glass and other surfaces are hot during operation AND cool down.
Hot glass will cause burns.

- Do not touch glass until it is cooled
- NEVER allow children to touch glass
- Keep children away
- CAREFULLY SUPERVISE children in same room as fireplace.
- Alert children and adults to hazards of high temperatures
- **High temperatures may ignite clothing or other flammable materials.**
- Keep clothing, furniture, draperies and other flammable materials away.

CAUTION

- Check building codes prior to installation.
- Installation MUST comply with local, regional, state and national codes and regulations.
 - Consult local building, fire officials or authorities having jurisdiction about restrictions, installation inspection, and permits.

CAUTION

Tested and approved for wood pellets and corn pellets.
Burning of any other type of fuel voids your warranty.

Installation and service of this appliance should be performed by qualified personnel. Hearth & Home Technologies recommends HHT Factory Trained or NFI certified professionals.



NOTE

To obtain a French translation of this manual, please contact your dealer or visit www.quadrafire.com

Pour obtenir une traduction française de ce manuel, s'il vous plaît contacter votre revendeur ou visitez www.quadrafire.com



and Welcome to the Quadra-Fire Family!

NOTE: Clearances may only be reduced by means approved by the regulatory authority having jurisdiction

A. Sample of Serial Number / Safety Label

LOCATION: Riveted to appliance behind left side panel. Remove cast side and swing label forward

	Test Lab & Report No.	Model	Serial Number																																																															
<p>SAFETY LABEL / ÉTIQUETTE DE SÉCURITÉ</p> <p>Appareil de chauffage inséré de combustible solide/de type de boulettes. "Pour Usage Avec Bois Solide et Champ de Mais égrené Seulement". Accepté dans l'installation dans les maisons mobiles. Cet appareil a été testé et enregistré pour l'usage dans les Maisons Mobiles en accord avec OAR 814-23-9000 jusqu'à 814-23-909.</p> <p>Testé à: ASTM #1509-04, ULC S628-93, ULC/ORD-C1482-M1990 Room Heating. Pellet Burning Type, (UM) 84-HUD POUR USAGE AVEC LES BOULETTES DE BOIS. OMNI-Test Laboratories, Inc. a déterminé que cet appareil se conforme avec la norme de l'Association Canadienne de normalisation (CSA) B415.1 ainsi que le Titre 40 du Code Fédéral de Régulations des États-Unis, partie 60, sous-partie AAA. "Accréditations OMNI-Test Laboratories": Le Conseil Canadien des Normes (CCNS/SCC), l'Institut des Standards Nationaux Américain (ANSI) et l'Agence de Protection Environnemental (EPA).</p> <p>Puissance de Rendement: 38,700 BTU/HR Puissance Électrique: 115 VAC, 60 Hz, Début 4.1 Amps, Courir 1.1 Amps. Éloignez le fil électrique de l'appareil. Ne pas faire passer le fil électrique au dessus ou en dessous de l'appareil. DANGER: Il y a risque de décharge électrique. Déconnectez le fil électrique de la prise de contact avant le service. Remplacez la vitre seulement avec une vitre céramique de 5 mm disponible chez votre fournisseur. Pour allumer, monter la température du thermostat au dessus de la température de la pièce, le poêle s'allumera automatiquement. Pour éteindre, descendre la température du thermostat en dessous de la température de la pièce. Pour des instructions supplémentaires, référez vous au manuel du propriétaire. Gardez la porte d'ouverture et la porte des cendres fermées hermétiquement durant l'opération.</p> <p>PRÉVENTION DES FEUX DE MAISON</p> <p>Installez et utilisez en accord avec les instructions d'installation et d'opération du fabricant. CONTACT BÂTIMENT LOCAL OU POUR CONNAÎTRE LES RESTRICTIONS ET INSPECTIONS INSTALLATION DANS VOTRE RÉGION.</p> <p>AVIS - Pour Les Maisons Mobiles: Ne pas installer dans une chambre à coucher. Un tuyau extérieur de combustion d'air doit être installé et ne doit pas être obstrué lorsque l'appareil est en usage. La structure intégrée du plancher, du plafond et des murs de la maison mobile doit être maintenue intacte. Référez vous aux instructions du fabricant et des codes locaux pour les précautions requises pour passer une cheminée à travers un mur ou un plafond combustibles, et les compensations maximums. Inspectez et nettoyez la cheminée fréquemment. Ne pas connecter cet appareil à une cheminée servant un autre appareil. Utilisez le système de ventilation de 3 or 4 inch (76-102mm) de diamètre de type "L" ou "PL".</p> <p>Masonry or Zero Clearance Dégagement de la maçonnerie ou Dégagement zéro</p> <table border="1" style="font-size: small;"> <tr><td>A</td><td>16 in.</td><td>406mm</td></tr> <tr><td>B</td><td>12 in.</td><td>305mm</td></tr> <tr><td>C</td><td>4.75 in.</td><td>121mm</td></tr> <tr><td>D</td><td>10 in.</td><td>254mm</td></tr> <tr><td>E</td><td>6 in.</td><td>152mm</td></tr> <tr><td>F</td><td>6 in.</td><td>152mm</td></tr> </table> <p>MINIMUM CLEARANCES TO COMBUSTIBLE MATERIALS ESPACES LIBRES MINIMUM DES MATÉRIEAUX COMBUSTIBLES:</p> <p>AS A BUILT-IN UNIT COMME APPAREIL INSÉRÉ</p> <table border="1" style="font-size: small;"> <tr><td>G</td><td>2 in. (51mm)</td><td>*Top Vent / Des Conduits Du Haut</td></tr> <tr><td>H</td><td>2.5 in. (64mm)**</td><td>**Rear Vent / Des Conduits Arrières</td></tr> <tr><td>I</td><td>2 in. (51mm)</td><td>Side Wall / Mur De Côté</td></tr> <tr><td>J</td><td>4 in. (102mm)</td><td>Back Wall to Insert / Mur Arrière du Inséré</td></tr> <tr><td>K</td><td>3 in. (76mm)</td><td>Back Wall to Flue Pipe / Mur Arrière Tuyau Rigide</td></tr> </table> <p>0 in. Clearance To Exposed Section and Face Trim / Espace libre de 0 mm de la section exposée et de la garniture du devant.</p> <p>*When constructing floor protection for your pellet appliance, any parts or materials used, must be non-combustible. * Lors de la construction de protection de sol pour votre appareil à granules, toute pièces ou matériaux utilisés, doivent être incombustibles.</p> <p style="font-size: x-small;">U.S. ENVIRONMENTAL PROTECTION AGENCY OMNI Test Laboratories, Inc., Portland, OR Report/Rapport 061-S-776-6.2 U.S. ENVIRONMENTAL PROTECTION AGENCY CERTIFIED TO COMPLY WITH 2015 PARTICULATE EMISSIONS STANDARDS AT 1.8 GHR EPA METHOD 28 AND 5G. NOT APPROVED FOR SALE AFTER MAY 15, 2020 THIS WOOD HEATER NEEDS PERIODIC INSPECTION AND REPAIR FOR PROPER OPERATION. CONSULT THE OWNER'S MANUAL FOR FURTHER INFORMATION. IT IS AGAINST FEDERAL REGULATIONS TO OPERATE THIS WOOD HEATER IN A MANNER INCONSISTENT WITH THE OPERATING INSTRUCTIONS IN THE OWNER'S MANUAL.</p>	A	16 in.	406mm	B	12 in.	305mm	C	4.75 in.	121mm	D	10 in.	254mm	E	6 in.	152mm	F	6 in.	152mm	G	2 in. (51mm)	*Top Vent / Des Conduits Du Haut	H	2.5 in. (64mm)**	**Rear Vent / Des Conduits Arrières	I	2 in. (51mm)	Side Wall / Mur De Côté	J	4 in. (102mm)	Back Wall to Insert / Mur Arrière du Inséré	K	3 in. (76mm)	Back Wall to Flue Pipe / Mur Arrière Tuyau Rigide	<p>Tested & Listed By: OMNI-Test Laboratories, Inc. Portland Oregon USA Report / Rapport #061-S-776-6.2</p> <p>Made in U.S.A. of US and imported parts.</p> <p>États-Unis-d'Amérique par des pièces d'origine américaine et pièces importées</p> <p>Manufactured by: HEARTH & HOME technologies 352 Mountain House Road, Halifax, PA 17032 www.quadrafire.com</p> <table border="1" style="font-size: x-small;"> <tr><td>2017</td><td>2018</td><td>2019</td></tr> <tr><td><input type="checkbox"/></td><td><input type="checkbox"/></td><td><input type="checkbox"/></td></tr> <tr><td>JAN</td><td>FEB</td><td>MAR</td></tr> <tr><td><input type="checkbox"/></td><td><input type="checkbox"/></td><td><input type="checkbox"/></td></tr> <tr><td>APR</td><td>MAY</td><td>JUN</td></tr> <tr><td><input type="checkbox"/></td><td><input type="checkbox"/></td><td><input type="checkbox"/></td></tr> <tr><td>JUL</td><td>AUG</td><td>SEP</td></tr> <tr><td><input type="checkbox"/></td><td><input type="checkbox"/></td><td><input type="checkbox"/></td></tr> <tr><td>OCT</td><td>NOV</td><td>DEC</td></tr> <tr><td><input type="checkbox"/></td><td><input type="checkbox"/></td><td><input type="checkbox"/></td></tr> </table> <p>DO NOT REMOVE THIS LABEL NE PAS ENLEVER L'ÉTIQUETTE</p> <p style="text-align: right;">7022-121_R6</p>	2017	2018	2019	<input type="checkbox"/>	<input type="checkbox"/>	<input type="checkbox"/>	JAN	FEB	MAR	<input type="checkbox"/>	<input type="checkbox"/>	<input type="checkbox"/>	APR	MAY	JUN	<input type="checkbox"/>	<input type="checkbox"/>	<input type="checkbox"/>	JUL	AUG	SEP	<input type="checkbox"/>	<input type="checkbox"/>	<input type="checkbox"/>	OCT	NOV	DEC	<input type="checkbox"/>	<input type="checkbox"/>	<input type="checkbox"/>	<p>Serial No. / N° de série</p> <p>HF</p> <p>BARCODE LABEL</p> <p>QUADRA-FIRE Castile Pellet Insert-B</p>	<p>Mfg By</p> <p>Mfg Date</p>
A	16 in.	406mm																																																																
B	12 in.	305mm																																																																
C	4.75 in.	121mm																																																																
D	10 in.	254mm																																																																
E	6 in.	152mm																																																																
F	6 in.	152mm																																																																
G	2 in. (51mm)	*Top Vent / Des Conduits Du Haut																																																																
H	2.5 in. (64mm)**	**Rear Vent / Des Conduits Arrières																																																																
I	2 in. (51mm)	Side Wall / Mur De Côté																																																																
J	4 in. (102mm)	Back Wall to Insert / Mur Arrière du Inséré																																																																
K	3 in. (76mm)	Back Wall to Flue Pipe / Mur Arrière Tuyau Rigide																																																																
2017	2018	2019																																																																
<input type="checkbox"/>	<input type="checkbox"/>	<input type="checkbox"/>																																																																
JAN	FEB	MAR																																																																
<input type="checkbox"/>	<input type="checkbox"/>	<input type="checkbox"/>																																																																
APR	MAY	JUN																																																																
<input type="checkbox"/>	<input type="checkbox"/>	<input type="checkbox"/>																																																																
JUL	AUG	SEP																																																																
<input type="checkbox"/>	<input type="checkbox"/>	<input type="checkbox"/>																																																																
OCT	NOV	DEC																																																																
<input type="checkbox"/>	<input type="checkbox"/>	<input type="checkbox"/>																																																																

Safety Alert Key:



- **DANGER!** Indicates a hazardous situation which, if not avoided will result in death or serious injury.
- **WARNING!** Indicates a hazardous situation which, if not avoided could result in death or serious injury.
- **CAUTION!** Indicates a hazardous situation which, if not avoided, could result in minor or moderate injury.
- **NOTICE:** Indicates practices which may cause damage to the appliance or to property.

TABLE OF CONTENTS

<p>A. Sample of Serial Number / Safety Label 2 B. Warranty Policy 4 1 Listing and Code Approvals 7 A. Appliance Certification 7 B. BTU & Efficiency Specifications 7 C. Glass Specifications 8 D. Electrical Rating 8 E. Mobile Home Approved 8 F. Sleeping Room 8 G. California - Prop65 8 2 Operating Instructions 9 A. Fire Safety 9 B. Non-Combustible Materials 9 C. Combustible Materials 9 D. Fuel Material and Fuel Storage 9 E. Before Your First Fire 10 F. Filling the Hopper 10 G. General Operating Information 10 H. Starting Your First Fire 11 I. Fire Characteristics 11 J. Feed Rate Adjustment Instructions 11 K. Ignition Cycles 12 L. Insert Removal 12 M. Restarting the Appliance 12 N. Clear Space 12 O. Thermostat Controls 13 P. Thermostat Setup Options 13 Q. Thermostat Operation Instructions 14 R. Thermostat Temperature Programs 14 S. Thermostat Other Features 15 T. Thermostat Battery Replacement 16 U. Frequently Asked Questions 17 3 Maintenance and Service 18 A. Quick Reference Maintenance Chart 18 B. General Maintenance and Cleaning 19 C. Soot or Creosote Fire Awareness 22</p>	<p>4 Troubleshooting Guide 23 5 Service Parts Replacement 26 A. Blower Replacement 26 B. Baffle & Brick Replacement 27 C. Re-installing Baffle & Brick Set 27 D. Igniter Replacement 29 E. Glass Replacement 29 6 Reference Materials 30 A. Component Functions 30 B. Component Locations 32 C. Service and Maintenance Log 33 D. Exploded Drawings 35 E. Service Parts List 36 F. Accessories 39</p>
--	---

Quadra-Fire is a registered trademark of Hearth & Home Technologies.

B. Warranty Policy

**Hearth & Home Technologies
LIMITED LIFETIME WARRANTY**

Hearth & Home Technologies, on behalf of its hearth brands (“HHT”), extends the following warranty for HHT gas, wood, pellet and electric hearth appliances that are purchased from an HHT authorized dealer.

WARRANTY COVERAGE:

HHT warrants to the original owner of the HHT appliance at the site of installation, and to any transferee taking ownership of the appliance at the site of installation within two years following the date of original purchase, that the HHT appliance will be free from defects in materials and workmanship at the time of manufacture. After installation, if covered components manufactured by HHT are found to be defective in materials or workmanship during the applicable warranty period, HHT will, at its option, repair or replace the covered components. HHT, at its own discretion, may fully discharge all of its obligations under such warranties by replacing the product itself or refunding the verified purchase price of the product itself. The maximum amount recoverable under this warranty is limited to the purchase price of the product. This warranty is subject to conditions, exclusions and limitations as described below.

WARRANTY PERIOD:

Warranty coverage for consumers begins at the date of installation. In the case of new home construction, warranty coverage begins on the date of first occupancy of the dwelling or six months after the sale of the product by an independent, authorized HHT dealer/distributor, whichever occurs earlier. However, the warranty shall commence no later than 24 months following the date of product shipment from HHT, regardless of the installation or occupancy date. The warranty period for parts and labor for covered components is produced in the following table.

The term “Limited Lifetime” in the table below is defined as: 20 years from the beginning date of warranty coverage for gas appliances, and 10 years from the beginning date of warranty coverage for wood and pellet appliances. These time periods reflect the minimum expected useful lives of the designated components under normal operating conditions.

Warranty Period		HHT Manufactured Appliances and Venting					
Parts	Labor	Gas	Pellet	Wood	Electric	Venting	Components Covered
1 Year		X	X	X	X	x	All parts and material except as covered by Conditions, Exclusions, and Limitations listed
2 years			X	X			Igniters, auger motors, electronic components, and glass
		X	X	X			Factory-installed blowers
				X			Molded refractory panels
		X					Ignition Modules
3 years			X				Firepots, burnpots, mechanical feeders/auger assemblies
5 years	1 year	X					Vent Free burners, Vent Free ceramic fiber logs, Aluminized Burners
			X	X			Castings and Baffles
6 years	3 years			X			Catalyst - limitations listed
7 years	3 years		X	X			Manifold tubes, HHT chimney and termination
10 years	1 year	X					Burners, logs and refractory
Limited Lifetime	3 years	X	X	X			Firebox and heat exchanger, Grate and Stainless Steel Burners, FlexBurn® System (engine, inner cover, access cover and fireback)
90 Days		X	X	X	X	X	All replacement parts beyond warranty period

WARRANTY CONDITIONS:

- This warranty only covers HHT appliances that are purchased through an HHT authorized dealer or distributor. A list of HHT authorized dealers is available on the HHT branded websites.
- This warranty is only valid while the HHT appliance remains at the site of original installation.
- This warranty is only valid in the country in which the HHT authorized dealer or distributor that sold the appliance resides.
- Contact your installing dealer for warranty service. If the installing dealer or distributor is unable to provide necessary parts, contact the nearest HHT authorized dealer or supplier. Additional service fees may apply if you are seeking warranty service from a dealer other than the dealer from whom you originally purchased the product.
- Check with your dealer in advance for any costs to you when arranging a warranty call. Travel and shipping charges for parts are not covered by this warranty.
- Limited Catalyst Warranty
 - o For wood burning products containing a catalyst, the catalyst will be warranted for a six-year period as follows: if the original catalyst or a replacement catalyst proves defective or ceases to maintain 70% of its particulate emission reduction activity (as measured by an approved testing procedure) within 36 months from the purchase date, the catalyst will be replaced for free.
 - o From 37 to 72 months a pro-rated credit will be allowed against a replacement catalyst and labor credit necessary to install the replacement catalyst. The proration rate is as follows:

Amount of Time Since Purchase	Credit Towards Replacement Cost
0 - 36 Months	100%
37 - 48 Months	30%
49 - 60 Months	20%
61 - 72 Months	10%

- o Any replacement catalyst will be warranted under the terms of the catalyst warranty for the remaining term of the original warranty. The purchaser must provide the name, address, and telephone number of the location where the product is installed, proof of original purchase date, date of failure, and any relevant information regarding the failure of the catalyst.

WARRANTY EXCLUSIONS:

This warranty does not cover the following:

- Changes in surface finishes as a result of normal use. As a heating appliance, some changes in color of interior and exterior surface finishes may occur. This is not a flaw and is not covered under warranty.
- Damage to printed, plated, or enameled surfaces caused by fingerprints, accidents, misuse, scratches, melted items, or other external sources and residues left on the plated surfaces from the use of abrasive cleaners or polishes.
- Repair or replacement of parts that are subject to normal wear and tear during the warranty period are not covered. These parts include: paint, wood and pellet gaskets, firebricks, grates, flame guides, batteries and the discoloration of glass.
- Minor expansion, contraction, or movement of certain parts causing noise. These conditions are normal and complaints related to this noise are not covered by this warranty.
- Damages resulting from: (1) failure to install, operate, or maintain the appliance in accordance with the installation instructions, operating instructions, and listing agent identification label furnished with the appliance; (2) failure to install the appliance in accordance with local building codes; (3) shipping or improper handling; (4) improper operation, abuse, misuse, continued operation with damaged, corroded or failed components, accident, or improperly/incorrectly performed repairs (5) environmental conditions, inadequate ventilation, negative pressure, or drafting caused by tightly sealed constructions, insufficient make-up air supply, or handling devices such as exhaust fans or forced air furnaces or other such causes; (6) use of fuels other than those specified in the operation instructions; (7) installation or use of components not supplied with the appliance or any other components not expressly authorized and approved by HHT; (8) modification of the appliance not expressly authorized and approved by HHT in writing; and/or (9) interruptions or fluctuations of electrical power supply to the appliance.
- Non-HHT venting components, hearth connections or other accessories used in conjunction with the appliance.
- Any part of a pre-existing fireplace system in which an insert or a decorative gas appliance is installed.
- HHT’s obligation under this warranty does not extend to the appliance’s capability to heat the desired space. Information is provided to assist the consumer and the dealer in selecting the proper appliance for the application. Consideration must be given to the appliance location and configuration, environmental conditions, insulation and air tightness of the structure.

This warranty is void if:

- The appliance has been over-fired, operated in atmospheres contaminated by chlorine, fluorine, or other damaging chemicals. Over-firing can be identified by, but not limited to, warped plates or tubes, deformation/warping of interior cast iron structure or components, rust colored cast iron, bubbling, cracking and discoloration of steel or enamel finishes.
- The appliance is subjected to prolonged periods of dampness or condensation.
- There is any damage to the appliance or other components due to water or weather damage which is the result of, but not limited to, improper chimney or venting installation.

LIMITATIONS OF LIABILITY

- The owner's exclusive remedy and HHT's sole obligation under this warranty, under any other warranty, express or implied, or in contract, tort or otherwise, shall be limited to replacement, repair, or refund, as specified above. In no event will HHT be liable for any incidental or consequential damages caused by defects in the appliance. Some states do not allow exclusions or limitation of incidental or consequential damages, so these limitations may not apply to you. This warranty gives you specific rights; you may also have other rights, which vary from state to state. EXCEPT TO THE EXTENT PROVIDED BY LAW, HHT MAKES NO EXPRESS WARRANTIES OTHER THAN THE WARRANTY SPECIFIED HEREIN. THE DURATION OF ANY IMPLIED WARRANTY IS LIMITED TO DURATION OF THE EXPRESSED WARRANTY SPECIFIED ABOVE.

1 Listing and Code Approvals

A. Appliance Certification

Model	Castile Pellet Insert-B
Laboratory	OMNI Test Laboratories, Inc.
Report No.	061-S-77d-6.2
Type	Solid Fuel Room Appliance/Pellet Fuel Burning Type Insert
Standard	ASTM E1509-2004, ULC S628-93 and ULC/ORD-C1482-M1990 Room Appliance Pellet Fuel Burning Type and (UM) 84-HUD, Mobile Home Approved

B. BTU & Efficiency Specifications

EPA Certification #:	940-14
EPA Certified Emissions:	1.8 grams per hour
*LHV Tested Efficiency:	N/A
**HHV Tested Efficiency:	N/A
***EPA BTU Output:	8,500 to 28,200 / hr.
****BTU Input:	11,600 to 38,700 / hr.
Vent Size:	3, 4 or 6 inches, "L" or "PL"
Hopper Capacity:	45 lbs.
Fuel	Wood Pellets
* Weighted average LHV efficiency using data collected during EPA emissions test.	
**Weighted average HHV efficiency using data collected during EPA emissions test.	
***A range of BTU outputs based on EPA Default Efficiency and the burn rates from the low and high EPA tests.	
****Based on the maximum feed rate per hour multiplied by approximately 8600 BTU's which is the average BTU's from a pound of pellets.	

NOTICE: THIS INSTALLATION MUST CONFORM WITH LOCAL CODES. IN THE ABSENCE OF LOCAL CODES YOU MUST COMPLY WITH THE **ASTM E1509-2004, ULC S628-93, ULC/ORD-C-1482-M1990, (UM) 84-HUD**

The Quadra-Fire Castile Pellet Insert meets the U.S. Environmental Protection Agency's emission limits for pellet appliances sold after May 15, 2015.

This pellet insert needs periodic inspection and repair for proper operation. It is against federal regulations to operate this pellet insert in a manner inconsistent with operating instructions in this manual.

C. Glass Specifications

This appliance is equipped with 5mm ceramic glass. Replace glass only with 5mm ceramic glass. Please contact your dealer for replacement glass.

D. Electrical Rating

115 VAC, 60 Hz, Start 4.1 Amps, Run 1.1 Amps

E. Mobile Home Approved



- This appliance is approved for mobile home installations when not installed in a sleeping room and when an outside combustion air inlet is provided.
- The structural integrity of the mobile home floor, ceiling, and walls must be maintained.
- The appliance must be properly grounded to the frame of the mobile home and use only Listed pellet vent Class “L” or “PL” connector pipe.
- Outside Air Kit, part OAK-ACC must be installed in a mobile home installation.

F. Sleeping Room

When installed in a sleeping room it is recommended that 3ft of vertical be installed prior to horizontally exiting the room and a smoke/CO alarm be installed in the bedroom. The size of the room must be at least 50ft³ per 1,000 Btu/hr stove input, if the stove exceeds the room size, out air must be installed.

G. California - Prop65

 WARNING
This product and the fuels used to operate this product (wood), and the products of combustion of such fuels, can expose you to chemicals including carbon black, which is known to the State of California to cause cancer, and carbon monoxide, which is known to the State of California to cause birth defects or other reproductive harm. For more information go to: WWW.P65Warnings.ca.gov

 WARNING
 Fire Risk. Hearth & Home Technologies disclaims any responsibility for, and the warranty will be voided by, the following actions: <ul style="list-style-type: none">• Installation and use of any damaged appliance.• Modification of the appliance.• Installation other than as instructed by Hearth & Home Technologies.• Installation and/or use of any component part not approved by Hearth & Home Technologies.• Operating appliance without fully assembling all components.• Operating appliance without legs attached (if supplied with appliance).• Do NOT Over fire - If appliance or chimney connector glows, you are over firing. Any such action that may cause a fire hazard.

Improper installation, adjustment, alteration, service or maintenance can cause injury or property damage. For assistance or additional information, consult a qualified installer, service agency or your dealer.

NOTE: Hearth & Home Technologies, manufacturer of this appliance, reserves the right to alter its products, their specifications and/or price without notice.
--

User Guide

2 Operating Instructions

 WARNING	
	<p>Fire Risk.</p> <ul style="list-style-type: none"> Do not operate appliance before reading and understanding operating instructions. Failure to operate appliance properly may cause a house fire.
	

Visit www.quadrafire.com/shopping-tools/videos to view product and use & care videos.

A. Fire Safety

To provide reasonable fire safety, the following should be given serious consideration:

- Install at least one smoke detector and CO monitor on each floor of your home.
- Locate detectors away from the heating appliance and close to the sleeping areas.
- Follow the detector’s manufacturer’s placement and installation instructions and maintain regularly.
- Conveniently locate a Class A fire extinguisher to contend with small fires.
- In the event of a hopper fire:
 - Evacuate the house immediately.
 - Notify fire department.

B. Non-Combustible Materials

Material which will not ignite and burn, composed of any combination of the following:

- | | | | |
|-----------|---------|------------|---------|
| - Steel | - Brick | - Concrete | - Glass |
| - Plaster | - Iron | - Tile | - Slate |

Materials reported as passing **ASTM E 136, Standard Test Method for Behavior of Metals, in a Vertical Tube Furnace of 750° C.**

C. Combustible Materials

Material made of/ or surfaced with any of the following materials:

- | | |
|--------------------|------------------------|
| - Wood | - Plastic |
| - Compressed Paper | - Plywood/OSB |
| - Plant Fibers | - Sheet Rock (drywall) |

Any material that can ignite and burn: flame proofed or not, plastered or non-plastered.

D. Fuel Material and Fuel Storage

Pellet fuel quality can greatly fluctuate. This appliance has been designed to burn a wide variety of fuels, giving you the choice to use the fuel that is most economical in your region.

Hearth & Home Technologies strongly recommends only using Pellet Fuel Institute (PFI) certified fuel.

Fuel Material

- Made from sawdust or wood by-products
- Depending on the source material it may have a high or low ash content.

Higher Ash Content Material

- Hardwoods with a high mineral content
- Fuel that contains bark
- Standard grade pellets, high ash pellets, corn and other biomass fuels

Lower Ash Content Material

- Softwoods
- Fuels with low mineral content
- Premium grade pellets

Corn

- Moisture content must be 15% or less
- Corn must be free of debris. Never burn corn straight from the field. It will clog the auger mechanism.
- Corn with excessive grain dust must be screened by sifting with 3/16 (4.76mm) inch mesh screening
- Do not use corn that contains additives such as oils or means or has been chemically treated with pesticides. It will void your warranty and destroy the exhaust system.

 CAUTION	
Do not burn fuel that contains an additive; (such as soybean oil).	
<ul style="list-style-type: none"> • May cause hopper fires • Damage to product may result <p>Read the ingredients list on the package.</p>	

Clinkers

Minerals and other non-combustible materials such as sand will turn into a hard, glass-like substance called a clinker when heated in the fire pot. Trees from different areas will vary in mineral content. That is why some fuels produce more clinkers than others.

Moisture

Always burn dry fuel. Burning fuel with high moisture content takes heat from the fuel and tends to cool the appliance, robbing heat from your home. Damp pellet fuel can clog the feed system.

Size

- Pellets are either 1/4 inch or 5/16 inch (6-8mm) in diameter
- Length should be no more than 1-1/2 inches (38mm)
- Pellet lengths can vary from lot to lot from the same manufacturer
- Due to length variations, the flame height (feed rate) may need adjusting occasionally.

Performance

- Higher ash content requires the ash drawer to be emptied more frequently
- Hardwoods require more air to burn properly
- Premium wood pellets produce the highest heat output.
- Burning pellets longer than 1-1/2 inches (38mm) can cause an inconsistent fuel feed rate and/or missed ignitions.

CAUTION

Tested and approved for wood pellets and shelled corn. Burning of any other type of fuel voids your warranty.

Changing to Different Fuel Type

- Empty the hopper of the previous fuel
- Thoroughly vacuum hopper before filling with the new fuel

The burn rate, BTU content and heat output will all vary depending on the fuel selected.

Storage

- Wood pellets should be left in their original sealed bag until using to prevent moisture absorption.
- Do not store any pellet fuel within the clearance requirements or in an area that would hinder routine cleaning and maintenance.

E. Before Your First Fire

1. First, make sure your appliance has been properly installed and that all safety requirements have been met. Pay particular attention to the fire protection, venting and thermostat installation instructions.
2. Double check that the ash drawer and firebox are empty!
3. Close the front door.

IMPORTANT DETAIL: The tip of the thermocouple must be in contact with the inside end of the thermocouple cover or missed ignitions can occur.

F. Filling the Hopper

Open the hopper lid by lifting the handle. Fill the hopper with fuel. Close the hopper lid. The unit will not feed with the hopper lid open and the fire will go out.

G. General Operating Information

1. Thermostat Calls For Heat

The appliance is like most modern furnaces; when the thermostat calls for heat, your appliance will automatically light and deliver heat. When the room is up to temperature and the thermostat is satisfied, the red call light will shut off and the appliance will shut down. The red call light is located behind the right access panel.

2. Heat Output Controls

This appliance is equipped with a heat output control switch that has three settings or burn rates; low, medium and high (**Figure 10.1**). The appliance will turn on and off as the thermostat demands. When the thermostat calls for heat, the appliance will always start up on High. After burning approximately 4 minutes, the appliance will then burn at the rate at which it was originally set. If the appliance is set at one of the lower settings, it will run quieter but takes longer to heat up an area than if it were set at a higher burn rate. Regardless of the burn rate, when the area is warm enough to satisfy the thermostat, the appliance will shut off.

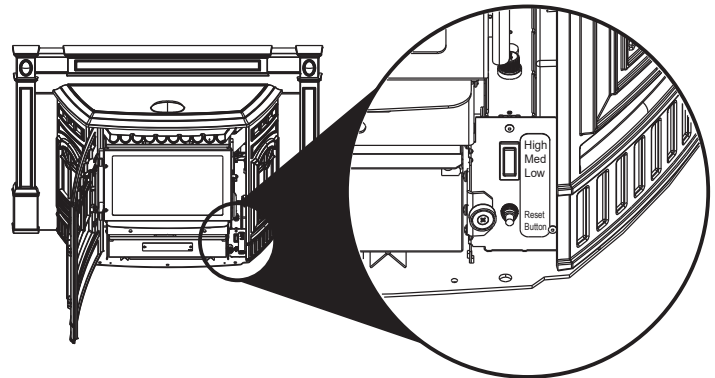

Figure 10.1

H. Starting Your First Fire

1. A thermostat is required for proper operation of this appliance, except for corn. At this time, fill the hopper with pellets, set the thermostat to its lowest setting. Plug the power cord into nearby outlet.
2. The exhaust blower will stay on for approximately 18 minutes even though the thermostat is not calling for heat. This is normal.
3. Locate the heat output control switch on the lower right side of the firebox behind decorative front door. Set to the HIGH setting and then adjust the thermostat to its highest setting. The red call light will be on which is located on the top of the junction box behind the right access panel. This indicates the thermostat is calling for heat (**Figure 10.1 on page 10**).
4. The fuel feed system and the igniter should now be on.
5. For your first fire it will be necessary to press the reset button once per minute until pellets start to drop into the fire pot, then press button 1 more time. This will fill the feed system and allow the appliance to begin dropping pellets. The appliance will continue to run as long as the thermostat is calling for heat.
6. Once the appliance has ignited, let it burn for approximately 15 minutes, then set the thermostat to the desired room temperature. Adjust the heat output control switch to the desired setting.

NOTE: We recommend the use of a 50-50 blend of corn and wood pellets. The only change in operation is that the feed rate may require a slight adjustment. If the appliance is running all of the time, 100% corn will work after the fire has been started using wood pellets.

I. Fire Characteristics

A properly adjusted fire with the heat output control button set on "HIGH" has a short active flame pattern that extends out of the fire pot approximately 4 inches (102mm). If the fire has tall flames with black tails and seems somewhat lazy, the feed rate will need to be reduced. If the fire is not 4 inches (102mm) tall, increase the feed rate. A medium and low setting will give a shorter flame. The flame will rise and fall somewhat. This is normal.

J. Feed Rate Adjustment Instructions

The feed adjustment control rod is factory set, and should be adequate for most fuels. The control rod will slide by only loosening the wing screw.

However, if the flame height is too high or too low, you will need to adjust the feed rate. Wait until the appliance has been burning for 15 minutes before making your adjustments and allow 15 minutes for feed adjustment to take effect. Make adjustments in approximately 1/2 inch increments.

1. Loosen the wing screw (**Figure 11.1**).
2. Adjust the fuel adjustment control rod towards to the right and up to increase the feed rate and flame height or to the left and down to decrease the feed rate and flame height.
3. Re-tighten the wing screw.

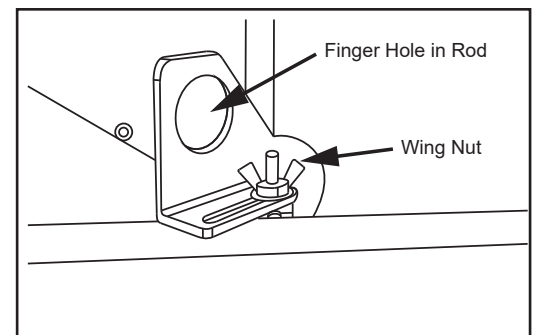



Figure 11.2

K. Ignition Cycles

1. During each ignition cycle, it is normal to see some smoke in the firebox. The smoke will stop once the fire starts.
2. The convection blower will automatically turn on after your appliance has reached the set temperature. This blower transfers heat from your appliance into the room, and will continue to run after the thermostat has stopped calling for heat until the appliance has cooled down.
3. Occasionally the appliance may run out of fuel and shut itself down. When this happens, the red call light will be on (**Figure 10.1 on page 10**). To restart it, fill the hopper and press the reset button. When you press the reset button the red call light will go out. Release the button and the light will come back on. You should see a fire shortly. If not, follow the instructions on **page 10**, "Starting Your First Fire".

 WARNING	
	Fire Risk Do NOT operate appliance:
	<ul style="list-style-type: none"> • With appliance door open. • Fire pot floor open. • Cleaning slide plates open. Do NOT store fuel: <ul style="list-style-type: none"> • Closer than required clearances to combustibles to appliance • Within space required for loading or ash removal.

CAUTION
HOT WHILE IN OPERATION. KEEP CHILDREN, CLOTHING AND FURNITURE AWAY. CONTACT MAY CAUSE SKIN BURNS.

L. Insert Removal

In the case that service or inspection is required the appliance may need to be removed from the wall.

1. Appliance must be unplugged before removal of appliance is possible. Unplug the appliance from its power source.
2. Remove insert surround from appliance, to ease the process of removal.
3. Non-clip the exhaust transition from the exhaust outlet in the back of the appliance. This is what connects the venting to the appliance. Removal of the clips will allow you to remove the appliance from the wall without damaging or adjusting the venting.
4. Slide appliance from the wall and rotate either direction as needed.

M. Restarting the Appliance

Restart Process

1. When the unit has run out of fuel and the "empty hopper" error code illuminates, add pellet fuel to the hopper.
2. Dump the ashes and clinkers built up in the fire pot by pulling the ash dump removal handle out several times. Make sure clinkers have dropped into the ash pan then return the handle to fully closed position.
3. Turn the dial control to OFF and then up to high 2X to prime.
4. After seeing pellets drop then turn to desired setting to reset the appliance control system. The appliance will then begin its startup sequence.



Restarting After a Power Failure



1. For an electrical disruption the appliance will start on its own without need for priming - providing the control system is asking for heat.
2. The appliance will always go through a normal shutdown sequence before restarting.

N. Clear Space

Mantel: Avoid placing candles and other heat-sensitive objects on mantel or hearth. Heat may damage these objects.

NOTICE: CLEARANCES MAY ONLY BE REDUCED BY MEANS APPROVED BY THE REGULATORY AUTHORITY HAVING JURISDICTION.

 WARNING	
	Fire Risk. Do NOT place combustible objects in front of the appliance. High temperatures may ignite clothing, furniture or draperies. Maintain a minimum clearance of 3 feet (914mm) in front of appliance.

 WARNING	
	Fire Risk. Keep combustible materials, gasoline and other flammable vapors and liquids clear of appliance.
	<ul style="list-style-type: none"> • Do NOT store flammable materials in the appliance's vicinity. • DO NOT USE GASOLINE, LANTERN FUEL, KEROSENE, CHARCOAL LIGHTER FLUID OR SIMILAR LIQUIDS TO START OR "FRESHEN UP" A FIRE IN THIS Appliance. • DO NOT BURN GARBAGE OR FLAMMABLE FLUIDS SUCH AS GASOLINE, NAPHTHA OR ENGINE OIL. • DO NOT USE CHEMICALS OR FLUIDS TO START THE FIRE. • Keep all such liquids well away from the appliance while it is in use. • Combustible materials may ignite.

O. Thermostat Controls

TEMPERATURE (HEAT / OFF) SWITCH:

Set this switch to HEAT to control your appliance. The OFF position will disable the appliance.

SET (MULTI- FUNCTION) SLIDE SWITCH:

This provides easy access to common settings, and should always remain in RUN unless items are being adjusted.

NOTE: When thermostat is set to "Manual" non-programmable mode, all positions of the SET slide switch will act like RUN.

UP / DOWN BUTTONS:

The UP and DOWN buttons are used to control the set temperature, or adjust any other on-screen items. An item flashing, is the item currently being adjusted.

HOLD BUTTON:

This button activates and deactivates the manual Temperature HOLD feature, which maintains a fixed set temperature indefinitely without following a program routine.

COPY BUTTON:

This is used to copy temperature program items from one day to the next. Also used to access the menu setup.

NEXT BUTTON:

This is used when setting items such as software options, and temperature programs when they are flashing on the screen. Pressing the NEXT button will cycle through which item is flashing.

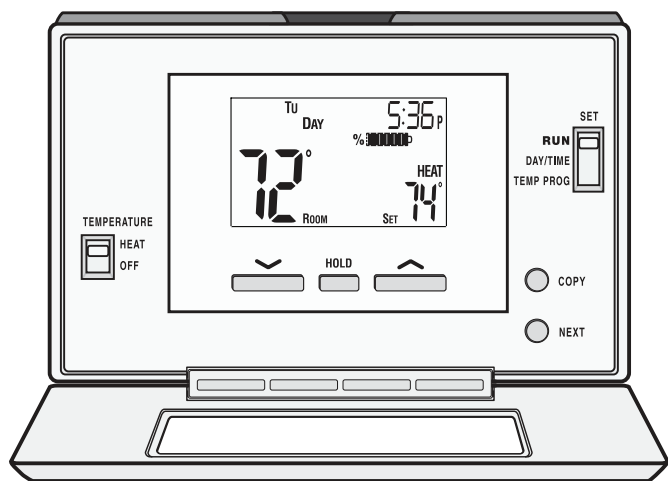

Figure 13.1

P. Thermostat Setup Options

Setup options for how the thermostat will function are performed using a menu on the display screen.

TO ACCESS THE SETUP MENU:

Move the System Mode Switch into the OFF position, and then hold down the COPY button for approximately 5 seconds until the screen changes. The menu will always start with item #01, and is advanced to each following item by a single press of the NEXT button. The options for each item are changed using the UP or DOWN buttons.

ITEM #01 (CLK = CLOCK FORMAT):

- 12Hr, default: This displays the clock times using standard AM and PM values.
- 24Hr: This displays the clock times using the military-time format (example 22:00 hours, without using AM or PM).

ITEM #02 (TMP = TEMPERATURE SCALE):

- F, default: Shows all temperature values in Fahrenheit.
- C: Shows all temperature values Celsius.

ITEM #03 (PROGRAMMING STYLE):

- 7 Day, default: This style uses a separate program routine for each of the 7 days in the week.
- 5/2 Day: This style uses a weekday program routine for Monday, Tuesday, Wednesday, Thursday, Friday, and a separate weekend program routine for Saturday and Sunday.
- Manual Non-Programmable: In this setting, there are no program routines for the thermostat to follow and the temperature control will be set only by the UP and DOWN buttons on the front panel.

ITEM #04 (PERD = EVENT OR PERIOD QUANTITY):

- 4P, default: Thermostat uses four Events per day (called MORN, DAY, EVE, and NITE).
- 2P: The thermostat uses two Events per day (called DAY and NITE).

NOTE: Event or Period Quantity feature is not accessible during Manual Non-Programmable mode.

ITEM #07 (DLAY = DELAY TIME):

- 5, default: Thermostat waits 5 minutes before turning the system back on after it was last run. This internal delay prevents the appliance from turning on too quickly after shutting down. The 5 minute setting is fine for most applications.
- 2: Same operation as above but reduced to 2 minutes between state changes.

NOTE: This delay does not happen when the thermostat is manually turned up and down.

ITEM #08 (TEMPERATURE DIFFERENTIAL):

- The thermostat works by turning your heating system on and off whenever the room temperature varies from the desired set-point temperature.
- Use the UP/DOWN buttons to change the number value between 1 and 9. Generally your system should cycle on about 3 to 6 times per hour. A smaller differential number makes the system cycle more frequently, so the room temperature is more precise and constant. A larger differential number will make the system remain on for a longer duration each time and decreases the number of cycles per hour.
- Default is set to 4.

Q. Thermostat Operation Instructions

SET DAY AND TIME:

Place the SET switch into the DAY/TIME position. With the day flashing press UP or DOWN to set the day or the week. Press NEXT and the clock time will start flashing. Use UP or DOWN to set the time; verify the AM/PM indicator is correct. Return the SET switch to RUN position when finished.

HEATING:

Basic operation of the thermostat can be obtained with the SET switch in the RUN position. The temperature can be adjusted using the UP and DOWN buttons. When the thermostat is first powered on, it will follow a default temperature routine that is preset from the factory (**Figure 14.1**).

Event	Time	Temperature
MORN	6:00 AM	70°F (21°C)
DAY	8:00 AM	62°F (17°C)
EVE	6:00 PM	70°F (21°C)
NITE	10:00 PM	62°F (17°C)

Figure 14.1

LCD DISPLAY BACK LIGHT:

The display screen is lighted to assist viewing at nighttime, or in locations with low light levels. Press any button on the front panel to activate the approximate 10 second back light.

TEMPERATURE OVERRIDE:

While thermostat is in RUN mode, the set temperature can be temporarily changed by pressing UP or DOWN. The temporarily changed set temperature will return to the programmed value stored in memory when start time of the next upcoming scheduled event is reached (MORN, DAY, EVE, OR NITE). While the temporary changed set temperature is in effect, the word OVERRIDE will be shown on the display screen. To cancel, move TEMPERATURE switch to OFF and back to HEAT again.

TEMPERATURE HOLD:

Temperature hold is used for maintaining a fixed set temperature; once a HOLD is initiated, the thermostat will maintain the set temperature indefinitely. To enter a HOLD state, press the HOLD button one time and the word HOLD will appear on the display. To cancel, press the HOLD button once again.

STATIC NOTICE

Thermostat is protected against normal static electric discharges, however to minimize the risk of damaging the thermostat in extremely dry weather, please touch a grounded metal object before touching the thermostat.

R. Thermostat Temperature Programs

The thermostat by default has 4 separate program events they are: MORN, DAY, EVE, and NITE. Each event ends at the start time of the following event.

NOTE: If the thermostat is set for 2 events a day instead of 4, the thermostat will only use the DAY and NITE events.

SET TEMPERATURE PROGRAMS:

1. Move TEMPERATURE switch to HEAT.
2. Move SET switch to TEMP PROG position.
3. Starting with Monday, use the UP or DOWN buttons to adjust the start time and set temperature for the MORN event, and then press NEXT button to advance.
4. Adjust the start time and set temperature of the DAY event then press NEXT button.
5. Continue in this same manner to adjust the start time and set temperatures for the EVE and NITE events for Monday.

NOTE: When the last event is finished for each day or group of days, the thermostat will advance forward into the next day or group of days.

6. Use steps 3 through 5 to set up the events for the rest of the week or group of days.
7. Return the SET switch back to RUN.

COPY PROGRAM FEATURE:

Using similar instructions as **SET TEMPERATURE PROGRAMS** the COPY button will allow a whole day of set program events to be copied to another day.

1. Move TEMPERATURE switch to HEAT as well as move SET switch to TEMP PROG position.
2. Starting with Monday, use the UP or DOWN buttons to adjust the start time and set temperature for the MORN, DAY, EVE, and NITE events. Press the COPY button and then press the NEXT button to advance to Tuesday.
3. With Tuesday displayed press COPY button. As all programs events from Monday will be copied to Tuesday (this will advance automatically to the next day; Wednesday, as the word COPY will appear on the screen for one second).
4. Continue in this pressing COPY button to set desired days with original setting.

NOTE: The word COPY will not appear on the display for Monday, but will display each day afterwards for approximately one second and the day of the week will automatically advance forward to the next day.

S. Thermostat Other Features

NOTE: All other features need to be completed in a timely manner as the thermostat will time out after 10 seconds.

TEMPERATURE CALIBRATION:

The internal temperature sensor in this thermostat is accurately calibrated at the factory, and in most cases alterations to this setting should not be needed. The temperature calibration feature allows you to manually offset the measured temperature by as much as plus or minus 5°F (3°C) from its original value. If several thermostats are used in the same house, this feature can be used to synchronize this thermostat to the others.

Change the temperature calibration:

1. Move TEMPERATURE switch to OFF.
2. Move SET switch to RUN.
3. Press and hold both UP and DOWN buttons together for at least 5 seconds; the words SET and CAL will appear on the display along with a single flashing temperature digit.
4. Use the UP or DOWN buttons to change the number of degrees desired for adjustment; 0° is the default value and also means no correction will be applied.
5. Press the NEXT button to accept the setting.

KEYPAD LOCKOUT:

There is the option to lock the front panel buttons to prevent unauthorized tampering of your thermostat settings.

To Lock the Keypad:

1. Move TEMPERATURE switch to HEAT.
2. Move SET switch to RUN.
3. Perform a single press of each button in the following sequence:
 - NEXT, NEXT, NEXT, HOLD
 A padlock will appear on the display screen.

To Unlock the Keypad:

1. Move TEMPERATURE switch to HEAT.
2. Move SET switch to RUN.
3. Perform a single press of each button in the following sequence:
 - NEXT, NEXT, NEXT, HOLD
 A padlock will no longer be present on the display screen.

HARDWARE RESET:

The hardware reset button; labeled HW RST, is a small round push button that is located in the middle of the circuit board, just below the battery holder (**Figure 15.1**). Pressing this button will:

- Cause the LCD display screen to become fully populated
- Thermostat to perform an internal system check of its components

If the thermostat appears to be acting in an erratic manner, pressing the HW RST button may remedy this behavior. The temperature programs are not erased when a hardware reset is performed, however the clock will have to be changed to match the current day and time.

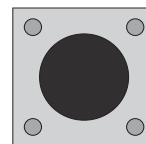

**HW
RST**

Figure 15.1

SOFTWARE RESET:

Software reset is used to erase ALL temperature events, and to return all user-adjustable software settings back to their original factory default settings.

To Perform a Software Rest:

1. Verify the thermostat's keypad is not locked.
2. Move TEMPERATURE switch to OFF.
3. Press and hold the UP, DOWN, and NEXT buttons all at the same time for at least 5 seconds. When the LCD display screen will become fully populated let go of all buttons at that point the screen will return to normal.

The clock will have to be changed to match the current day and time.

T. Thermostat Battery Replacement

This thermostat is powered by two "AA" Alkaline batteries. The batteries should be replaced AT LEAST once per year to ensure reliable operation or sooner if the LO BATT appears on the display screen. The batteries are located on the back of the thermostat's circuit board. The front portion of the thermostat can be removed from the back half by using the tabs on the top edge of the thermostat housing (Figure 16.1).

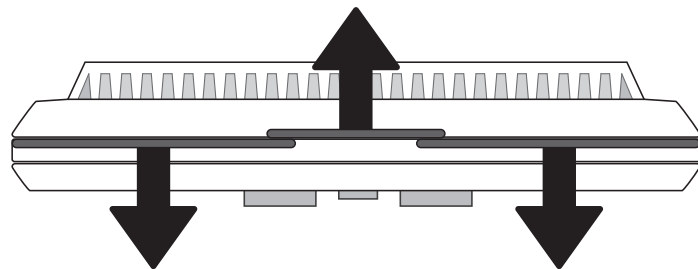

Figure 16.1

When installing new batteries, it is recommended using only brand new "AA" size alkaline batteries. Please verify the polarity markings shown in the battery compartment before adding batteries to the compartment. When finished, line up the front of the thermostat to the base, and firmly press together to securely latch the front and back halves together properly.

BATTERY GRAPHIC:

Anytime time the batteries are physically present in the thermostat, there will be a visual indicator showing the life of the battery. This will appear on the display screen (Figures 16.2 & 16.3).



Figure 16.2 - Full battery icon



Figure 16.3 - Low battery icon

CONNECT THERMOSTAT WIRES TO APPLIANCE:

There is a 4 screw terminal block located on the back lower left corner of the stove directly above the power cord inlet. The center 2 screws are for the thermostat wires (Figure 16.4).

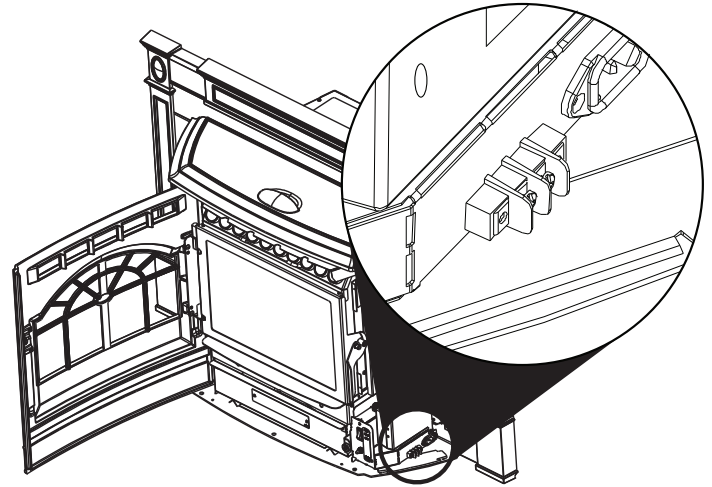



Figure 16.4

 CAUTION	
	Shock hazard.
	<ul style="list-style-type: none"> • Do NOT remove grounding prong from plug. • Plug directly into properly grounded 3 prong receptacle. • Route cord away from appliance. • Do NOT route cord under or in front of appliance.

U. Frequently Asked Questions

ISSUES		SOLUTIONS	
1	Metallic noise.	1	Noise is caused by metal expanding and contracting as it heats up and cools down, similar to the sound produced by a furnace or heating duct. This noise does not affect the operation or longevity of your insert.
2	Ash buildup on glass.	2	This is normal. Clean the glass.
3	Glass has turned dirty.	3	Excessive build up of ash. The lower burn settings will produce more ash, the higher burn settings produce less. The more it burns on low the more frequent cleaning of the glass is required.
4	Fire has tall flames with black tails and is lazy.	4	The feed rate needs to be reduced or the fire pot needs cleaning. Heat exchanger of exhaust blower needs cleaning.
5	Smokey start-up or puffs of smoke from the air wash.	5	Either the fire pot is dirty or there is too much fuel at start-up and not enough air. Close down feed rate 1/4 inch at a time until this no longer happens.
6	Large flame at start-up.	6	This is normal. Flame will settle down once the fire is established.

CONTACT YOUR DEALER for additional information regarding operation and troubleshooting.
Visit www.quadrafire.com to find a dealer.

CAUTION

Odors and vapors released during initial operation.

- Curing of high temperature paint.
- Open windows for air circulation.

Odors may be irritating to sensitive individuals.

3 Maintenance and Service

When properly maintained, your fireplace will give you many years of trouble-free service. Contact your dealer to answer question regarding proper operation, troubleshooting and service for your appliance. Visit www.quadrafire.com/owner-resources to view basic troubleshooting, FAQs, use & care videos. We recommend annual service by a qualified service technician.

This pellet insert has a manufacturer-set minimum low burn rate that must not be altered. It is against federal regulations to alter this setting or otherwise operate this pellet insert in a manner inconsistent with operating instructions in this manual.

CAUTION



Shock and Smoke Hazard

- Turn down thermostat, let appliance completely cool and exhaust blower must be off. Now you can unplug appliance before servicing.
- Smoke spillage into room can occur if appliance is not cool before unplugging.
- Risk of shock if appliance not unplugged before servicing appliance.

Follow the detailed instructions found in this section for each step listed in the chart below.

A. Quick Reference Maintenance Chart

Cleaning or Inspection	Frequency		Daily	Weekly	Every 2 Weeks	Monthly	Yearly
Ash Pan - Burning Wood Pellets	Every 5 bags of fuel	OR		X			
Ash Pan - Burning Alternate Fuels	Every 1 bag of fuel	OR	X				
Ash Removal from Firebox	More frequently depending on the fuel type or ash build-up	OR		X			
Auto-Clean Inspection	More frequently depending on the fuel type	OR				X	
Blower, Combustion (Exhaust)	More frequently depending on the fuel type	OR					X
Blower, Convection	More frequently depending on the operating environment	OR					X
Door Latch Inspection	Prior to heating season	OR				X	
Firebox - Prepare for Non-Burn Season	At end of heating season	OR					X
Fire pot - Burning Softwood Pellets	Every 5 bags	OR		X			
Fire pot - Burning Hardwood Pellets	Every 3 bags	OR		X			
Fire pot - Burning Alternate Fuels	Every 1 bag	OR	X				
Glass	When clear view of fire pot becomes obscured	OR		X			
Heat Exchanger & Drop Tube	Every 1 ton of fuel	OR			X		
Hopper	Every 1 ton of fuel or when changing fuel types	OR				X	
Venting System	More frequently depending on the fuel type	OR					X

NOTICE: THESE ARE RECOMMENDATIONS. CLEAN MORE FREQUENTLY IF YOU ENCOUNTER HEAVY BUILD-UP OF ASH AT THE RECOMMENDED INTERVAL OR YOU SEE SOOT COMING FROM THE VENT. NOT PROPERLY CLEANING YOUR APPLIANCE ON A REGULAR BASIS WILL VOID YOUR WARRANTY.

B. General Maintenance and Cleaning

1. Types of Fuel



Depending on the type of fuel you are burning will dictate how often you have to clean your fire pot.

If the fuel you are burning has a high dirt or ash content or you are burning shelled field corn, it may be necessary to clean the fire pot more than once a day.

Dirty fuel will cause clinkers to form in the fire pot. A clinker is formed when dirt, ash or a non-burnable substance is heated to 2000°F (1093°C) and becomes glass-like. See **page 34** in this section for more details on fuels with high ash content.

2. Cleaning Fire pot with Cleaning Rod & Fire pot Clean-Out Tool

- **Frequency:** Daily or more often as needed
- **By:** Homeowner
- a. The appliance must be in complete shutdown and cool and the exhaust blower off. If you are just cleaning the fire pot, there is no need to unplug the insert.
- b. Pull fire pot cleaning rod OUT and IN a couple of times to help shake debris loose. If rod is hard to pull, it may be necessary to use your fire pot clean-out tool to chip away material that has built up on the bottom plate of the fire pot and to push out any clinkers. Larger clinkers may have to be removed from the top of the fire pot. Corn clinkers can be especially difficult to break up.
- c. The fire pot floor plate must be fully closed when finished (**Figure 19.1**).

	WARNING
	<p>Fire Risk.</p> <ul style="list-style-type: none"> • NEVER pull fire pot cleaning rods or cleaning slide plates when appliance is operating. Hot pellets may fall into ash pan and may start a fire or have mis-starts due to lack of vacuum.

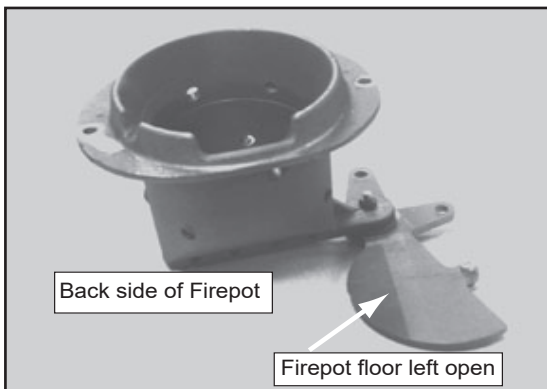

Figure 19.1

3. Ash Removal from Firebox

- **Frequency:** Weekly or more frequently depending on ash build-up
- **By:** Homeowner

- a. There must not be any hot ashes in the firebox during cleaning so allow the appliance to completely cool. Frequent cleaning of the ash in the firebox will help slow down the build-up of ash in the exhaust blower and vent system.
- b. Plug in your appliance, if unplugged, and turn the thermostat on and immediately shut it off to start the exhaust blower on its cycle time. It will pull fly ash out the exhaust instead of into the room.
- c. Open door. There are 2 cleaning slide plates to the left and right of the fire pot with finger holes. Pull both slide plates out and sweep the remaining ash from the firebox into the 2 open holes. A paint brush works well for this. Close slide plates.
- d. This ash is deposited in the same ash drawer as the fire pot debris. The ash drawer should be emptied every time you clean the firebox. Remember to place the ash and debris into a metal or non-combustible container.
- e. The 2 cleaning slide plates must be fully closed when cleaning is complete.

4. Cleaning Ash Drawer

- **Frequency:** Weekly or every 5 bags of fuel
- **By:** Homeowner



Locate the ash drawer underneath the fire pot and slide the ash drawer straight out. Empty into a non-combustible container and re-install ash drawer.

	WARNING
	<p>Fire Risk.</p> <ul style="list-style-type: none"> • The cleaning slide plates must be fully CLOSED when appliance is operating. Hot pellets may fall into ash pan and start a fire.

5. Disposal of Ashes

- **Frequency:** As needed
 - **By:** Homeowner
- Ashes should be placed in a metal container with a tight-fitting lid. The closed container of ashes should be placed on a non-combustible floor or on the ground, well away from all combustible materials, pending final disposal.

If the ashes are disposed of by burial in soil or otherwise locally dispersed, they should be retained in the closed container until all cinders have been thoroughly cooled.

	WARNING
	<p>Disposal of Ashes.</p> <ul style="list-style-type: none"> • Ashes should be placed in metal container with tight fitting lid. • Ashes should be retained in closed container until all cinders have thoroughly cooled.

6. Cleaning Heat Exchanger Chambers

- **Frequency:** Weekly or every 1 ton of fuel
- **By:** Homeowner

The amount of ash buildup in the firebox will be a good guide to determine how often you should clean the heat exchangers.

- a. Allow the appliance to completely cool down before pulling the cleaning rods. Turn the thermostat on and then immediately off to start the exhaust blower on its cycle time. It will pull fly ash out the exhaust instead of into the room.
- b. Locate the 2 exposed rods directly underneath the heat exchanger tubes (**Figure 20.1**).
- c. To clean, pull the rods straight out until it stops, approximately 8 inches (203mm). Slide the rods OUT and IN a couple of times.

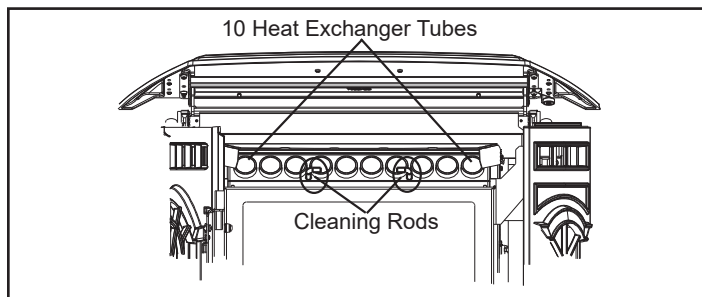

Figure 20.1

WARNING

Heat exchanger cleaning rods may be warm to the touch. For safety purposes wear gloves.

Do not pull heat exchanger cleaning rods while appliance is operating.

Push cleaning rods IN when done, DO NOT leave cleaning rods OUT. Injury can occur.

7. Cleaning Beneath Heat Exchanger

- **Frequency:** Monthly or every 1 ton of fuel
 - **By:** Homeowner
- a. Be sure the appliance is allowed to cool, has been unplugged and the exhaust blower is off.
 - b. A more thorough cleaning is needed to remove the excess ash that is left behind from the use of the cleaning rods for the heat exchanger tubes.
 - c. The ash will be resting on the back of the baffle. This will require removing the cast baffle. Please refer to **page 35** for a detailed explanation of removing the baffle.

8. Cleaning the Exhaust Path

- **Frequency:** Every 25 bags or monthly or more frequently depending on ash build-up.
 - **By:** Homeowner
- a. Appliance must be completely cool.
 - b. Open cast hinge face. Remove baffle and right brick and thoroughly vacuum the area and continue throughout the rest of the firebox.
 - c. Replace right brick and baffle and close cast hinge face.

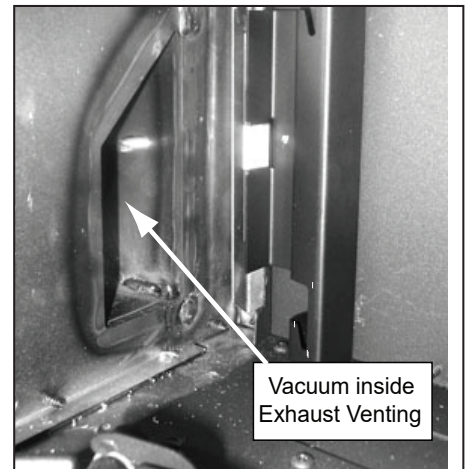

Figure 20.2

9. Cleaning the Hopper

- **Frequency:** Monthly or every 1 ton of fuel
- **By:** Homeowner

After burning approximately 1 ton of fuel you will need to clean the hopper to prevent sawdust build-up. A combination of sawdust and pellets on the auger reduces the amount of fuel supply to the fire pot. This can result in nuisance shutdowns and mis-starts.

- a. The appliance must be in complete shutdown. Allow the appliance to completely cool down.
- b. Empty the hopper of any remaining pellets.
- c. Vacuum the hopper and feed tube.

NOTE: Hearth & Home Technologies recommends to use a heavy duty vacuum cleaners specifically designed for solid fuel appliance cleaning.

10. Soot and Fly Ash: Formation & Need for Removal in Exhaust Venting System.

- **Frequency:** Yearly or more frequently depending on ash build-up
- **By:** Qualified Service Technician/Homeowner

The products of combustion will contain small particles of fly-ash. The fly-ash will collect in the exhaust venting system and restrict the flow of the flue gases. Incomplete combustion, such as occurs during startup, shutdown, or incorrect operation of the room appliance will lead to some soot formation which will collect in the exhaust venting system. The exhaust venting system should be inspected at least once every year to determine if cleaning is necessary.

The venting system may need to be cleaned at least once a year or more often depending upon the quality of your fuel or if there is a lot of horizontal pipe sections. Ash will build up more quickly in the horizontal sections.

11. Cleaning the Glass

- **Frequency:** When clear view of the fire pot is obscure
 - **By:** Homeowner
- Appliance must be completely cool before cleaning glass.
 - Use a damp paper towel or any non-abrasive glass cleaner. Wipe off with dry towel.

12. Door Latch Inspection

- **Frequency:** Prior to heating season
- **By:** Homeowner

The door latch is non-adjustable but the gasket between the glass and firebox should be inspected periodically to make sure there is a good seal.

NOTE: There is no gasket on the bottom of glass.

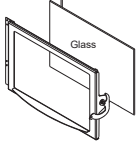
CAUTION	
	<p>Handle glass assembly with care.</p> <p>When cleaning glass:</p> <ul style="list-style-type: none"> • Avoid striking, scratching or slamming glass. • Do NOT clean glass when hot. • Do NOT use abrasive cleaners. • Use a hard water deposit glass cleaner on white film. • Refer to maintenance instructions.

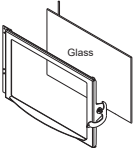
WARNING	
	<p>Handle glass with care.</p> <ul style="list-style-type: none"> • Inspect the gasket to ensure it is undamaged. • Do NOT strike, slam or scratch glass. • Do NOT operate appliance with glass assembly removed.

13. Cleaning Exhaust Blower - Requires No Lubrication

- **Frequency:** Yearly or as needed
 - **By:** Quality Service Technician/Homeowner
- Remove left & right brick. The exhaust blower is behind the right brick. Vacuum this area thoroughly. See **page 24** for removing bricks. Re-install bricks when done.

14. Cleaning Convection Blower - Requires No Lubrication

- **Frequency:** Yearly or as needed
- **By:** Qualified Service Technician
- **Task:** Contact your local dealer.

15. Preparing Firebox for Non-Burn Season

- **Frequency:** At the end of the heating season
 - **By:** Homeowner
- Be sure the appliance is allowed to cool, has been unplugged and the exhaust blower is off.
 - Remove all ash from the firebox and vacuum thoroughly.
 - Paint all exposed steel, including cast-iron.
 - Use the Touch-Up paint supplied with the appliance; or,
 - Purchase paint from your local dealer.
 - Must use a high-temperature paint made specifically for heating appliances.

WARNING	
	<p>Fire Risk</p> <ul style="list-style-type: none"> • High ash fuels, or lack of maintenance, can cause the fire pot to overfill. Follow proper shutdown procedure if ash build up exceeds half way point. • Failure to do so could result in smoking, sooting and possible hopper fires.

C. Soot or Creosote Fire Awareness

The chimney should be inspected periodically during the heating season to determine if a creosote build-up has occurred. If a significant layer of creosote has accumulated (1/8 inch [3mm] or more) it should be removed to reduce the risk of chimney fire.

Check daily for creosote build-up until experience shows how often you need to clean to be safe. Be aware that the hotter the fire the less creosote is deposited, and weekly cleaning may be necessary in the mild weather even though monthly cleaning may be enough in the coldest months. Contact your local municipal or provincial fire authority for information on how to handle a chimney fire.

In the event of a soot or creosote fire, close the firebox door, exit the building immediately and contact the proper fire authorities.

DO NOT under any circumstances re-enter the building.

D. High Ash Fuel Content Maintenance

- **Frequency:** When the ash build-up exceeds more than half way up the fire pot.
- **By:** Homeowner

Poor quality pellet fuel, or lack of maintenance, can create conditions that make the fire pot fill quickly with ashes and clinkers.

This condition makes the appliance susceptible to overfilling the fire pot with pellets which may result in smoking, sooting and possible hopper fires. **Figure 22.1** shows an example where the fire pot overfills, pellets back up into the feed tube and ash has accumulated in the firebox.

An inefficient and non-economical method of burning of fuel caused by poor quality pellet fuel is shown in **Figure 22.2**.

The correct flame size when good quality, premium pellet fuel is burned is shown in **Figure 22.3**.

If the ash buildup exceeds the half way point in the fire pot **IMMEDIATE ATTENTION AND CLEANING IS REQUIRED.**

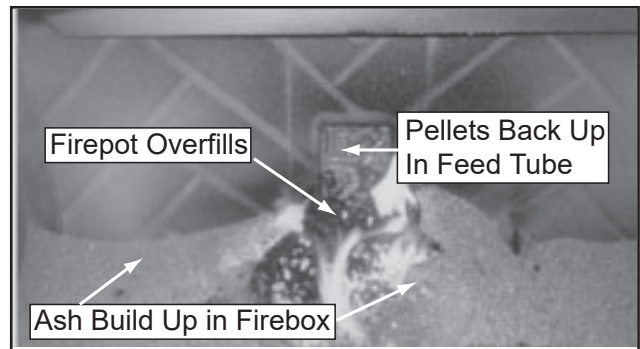

Figure 22.1

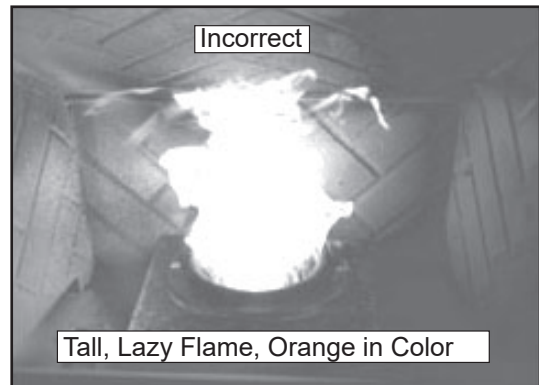

Figure 22.2

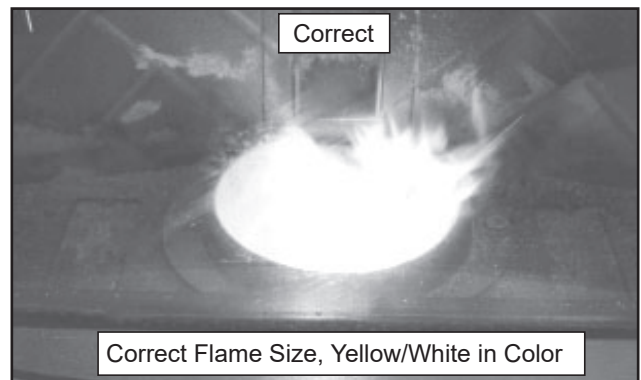

Figure 22.3

4 Troubleshooting Guide

With proper installation, operation, and maintenance your appliance will provide years of trouble-free service. If you do experience a problem, this troubleshooting guide will assist a qualified service person in the diagnosis of a problem and the corrective action to be taken. This troubleshooting guide can only be used by a qualified service technician.

Symptom	Possible Cause	Corrective Action
Plug in appliance - No response.	No current to outlet. 7 amp fuse defective. #3 snap disc tripped or defective. Control box defective.	Check circuit breaker at service panel. Replace fuse. Reset or replace snap disc. Replace control box.
Call light on. No fire. No fuel in fire pot.	Out of fuel. #2 snap disc may be defective. Vacuum switch not closing, no vacuum. Control box defective.	Check hopper. Fill with fuel. Replace snap disc. Check exhaust blower is plugged in and operating. Check vacuum switch is plugged in. Check vacuum hose is in good condition, clear and connected at both ends. Check thermocouple is in good condition and plugged in properly. Make sure venting system is clean. Make sure front door is closed. Replace control box.
Call light on. No fire. Partially burned fuel in fire pot.	Fire pot clean-out plate not closed. Fire pot is dirty (missed ignition).	Check that fire pot clean-out plate is fully closed. Clean fire pot. Make sure there is no clinker in the fire pot. See page 19. Clinkers may have to be broken up with fire pot clean-out tool or other means.
Call light on. No fire. Unburned pellets in fire pot.	Fire pot clean-out plate not closed. Fire pot is dirty. The ignition hole between the igniter bracket and fire pot is blocked. Igniter not working. Control box defective.	Check that fire pot clean-out plate is fully closed. Clean fire pot. Make sure there is not a clinker in the fire pot. Clinkers may have to be pushed out of fire pot with fire pot clean-out tool or other means. Scrape with solid piece of wire or fire pot tool. Remove ash drawer to see if igniter is glowing red on start-up. Check igniter wires for good connection. Replace igniter using 1/4 inch (6mm) male / female spade connectors. Replace control box.
Slow or smoky start-up.	Fire pot clean-out plate not closed. Fire pot is dirty. Excessive amount of fuel at start-up.	Check that fire pot clean-out is fully closed. Clean fire pot. Make sure there is not a clinker in the fire pot. Clinkers may have to be pushed out of fire pot with fire pot clean-out tool or other means. Reduce feed rate using feed rate adjustment control rod located inside hopper.

Symptom	Possible Cause	Corrective Action
Slow or smoky start-up (Cont'd)	Dirty exhaust and/or venting system.	Check for ash build up in appliance, including behind rear panels, firebox, heat exchanger, exhaust blower and venting.
Feed system fails to start.	<p>Out of fuel. #2 snap disc may be defective.</p> <p>Vacuum switch not closing. No vacuum.</p> <p>Feed system jammed or blocked.</p> <p>Feed spring not turning with feed motor.</p> <p>Feed motor defective or not plugged in.</p>	<p>Check hopper, fill with fuel. Replace snap disc.</p> <p>Firebox door must be closed securely. Check exhaust blower is plugged in and operating. Check vacuum switch is plugged in. Check vacuum hose is in good condition, clear and connected at both ends. Check thermocouple is in good condition and plugged in properly. Make sure venting system is clean. NOTE: High winds blowing into the venting system can pressurize the firebox causing loss of vacuum. Empty hopper of fuel. Use a wet/dry vacuum cleaner to remove remaining fuel, from hopper, including feed tube. Check feed chute for obstructions. Loosen 2 screws and jiggle feed assembly.</p> <p>Check that set screw is tight on feed spring shaft at end of feed motor.</p> <p>Check connections on feed motor, replace if defective.</p>
No call light. Appliance does not begin start sequence.	<p>Thermostat not set to a high enough temperature.</p> <p>Snap Disc #3 tripped.</p> <p>No power.</p> <p>Fuse blown.</p> <p>Connections at thermostat and/or appliance not making proper contact.</p> <p>Defective thermostat or thermostat wiring.</p> <p>Control box defective.</p>	<p>Adjust thermostat above room temperature.</p> <p>Reset snap disc.</p> <p>Connect to power.</p> <p>Replace fuse.</p> <p>Check connections at thermostat and appliance.</p> <p>Replace thermostat or wiring. NOTE: To test thermostat and wiring, use a jumper wire at the thermostat block on the appliance to by-pass thermostat and wiring.</p> <p>Replace control box.</p>
Appliance fails to shut off.	Call light on.	<p>Turn thermostat off.</p> <p>If call light does not go out, disconnect thermostat wires from appliance. If call light does go out, thermostat or wires are defective.</p>

Symptom	Possible Cause	Corrective Action
Convection blower fails to start.	#1 snap disc defective. Blower not plugged in. Blower is defective. Control box is defective.	Replace snap disc. Check that blower is plugged into wire harness. Replace blower. Replace control box.
Exhaust blower fails to start or does not shut off.	Blower not plugged in. Blower is clogged with ash. Blower is defective. Control box is defective.	Check that blower is plugged into wire harness. Clean exhaust system. Replace blower. Replace control box.
Large, lazy flame, orange color. Black ash on glass.	Dirty appliance. Poor fuel quality, high ash content. Fire pot clean-out plate not completely closed. Excessive amount of fuel.	Clean appliance, including fire pot, heat exchangers and venting system. Remove stainless steel baffle from firebox to clean ash from on top of baffle. Clean behind rear brick panels. Change fuel brand to premium. Check that fire pot clean-out plate is fully closed. Reduce feed rate using feed rate adjustment control rod located inside hopper.
Nuisance shutdowns.	Low flame. Sawdust buildup in hopper. Feed motor is reversing. Defective thermocouple. Defective control box Fire pot more than 1/2 full	Increase feed by opening feed rate adjustment control rod located inside hopper. Clean hopper, see page 20 . Check for good connections between feed motor and wire harness. Replace thermocouple. Replace control box. See page 22 for detailed instructions for "High Ash Fuel Content Maintenance"
Appliance calls for heat. Call light illuminates. Exhaust blower starts. No feed or igniter.	Thermocouple is defective or not properly plugged in. Defective control box	Check connections on thermocouple or replace if defective. A flashing yellow light on the control box indicates a problem with the thermocouple. Replace control box.
Hopper lid not closed all the way	Switch or magnet is out of adjustment (auger will not function)	Close the lid. If that doesn't work, adjust or replace the switch or magnet

5 Service Parts Replacement

A. Blower Replacement

1. Combustion (Exhaust) Blower Replacement

- If you have adequate clearance you will not have to remove the panel set and disconnect flue, if not then you will have to remove the panel set and disconnect the flue.
- Pull appliance out onto the hearth.
- Remove right cast side.
- Disconnect the white and blue wires from the blower.
- Remove blower mounting screws (not housing bolts), **Figure 26.1**, from blower housing and remove blower. The replacement blower is shipped with a housing. If you do not need the housing, discard it. If you do need to replace the housing you will also need to replace the gasket. See Service Parts List for the part number.
- Re-install in reverse order.

2. Convection Blower Replacement

- The blower is located at the bottom rear of the insert. If an outside air kit is also installed, you will first need to remove the outside air flange by removing the 2 screws using a Phillips head screwdriver. You do not need to remove the flex pipe from the flange.
- If you have adequate clearance you will not have to remove the panel set and disconnect flue, if not then you will have to remove the panel set and disconnect the flue.
- Pull appliance out onto the hearth.
- Remove left cast side.
- Disconnect the wires from the blower. The wires coming from the wiring harness are purple & white and the wires from the blower are black.
- The blower is held in place with a wing screw.
- Re-install in reverse order.

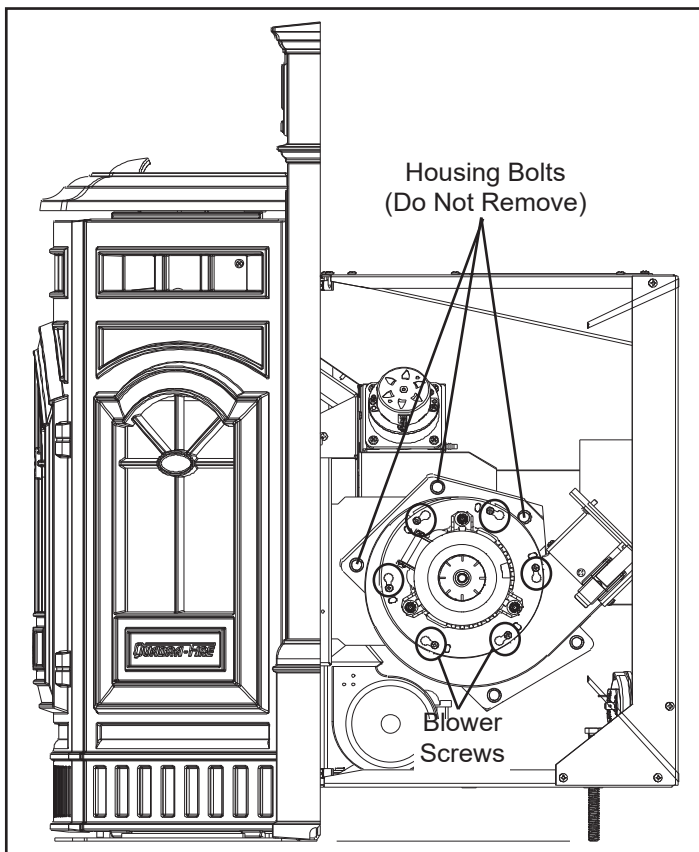

Figure 26.1

B. Baffle & Brick Replacement

1. Follow proper shutdown procedures in Section 10.
2. The top baffle has a hook on the bottom left side that rests on the top lip of the cast brick. There is a tab on the bottom right side that hooks into the side bracket. Remove the top baffle by first pulling the baffle forward until back edge drops down. Then slide baffle back until the front edge clears the shelf that it had been resting on (Figure 27.1).
3. The top baffle must be removed before you can remove the right and left brick. Remove the right brick by holding top lip of brick and lifting up, then push outside edge back. Slide brick to the right until it is flush with the firebox. Rotate the inside edge of the brick forward and remove brick. Repeat for left brick (Figure 27.2).

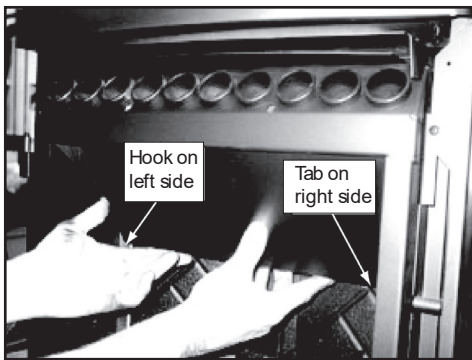

Figure 27.1

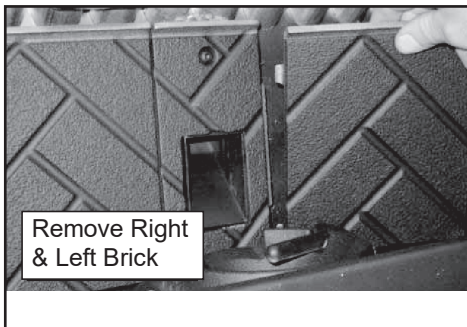

Figure 27.2

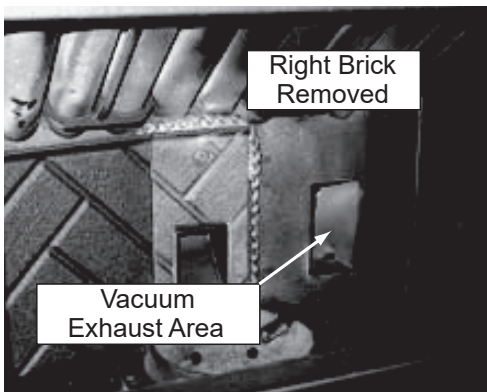

Figure 27.3

C. Re-installing Baffle & Brick Set

1. Place right brick in behind the right bracket, and then slide to the left so the tabs are behind the center brick (Figure 27.4).
2. The brick will be flush against the back wall and notches exposed in the side bracket (Figure 27.5).
3. Lift slightly and pull the right edge of the brick forward until it stops and then drops down into both top and bottom notches of right bracket and locks into place (Figures 28.1 and 28.2).
4. Repeat for left brick.
5. Insert baffle into top front inside the firebox and pull forward. Then raise up the bottom end and insert baffle tab into slot on the top of the right bracket to lock into place (Figure 27.3). Place the left side hook at the bottom of the baffle over the top edge of brick for stability (Figure 27.4).
6. The baffle does not completely cover the top of the firebox. There is an opening on the left as shown in Figure 27.5.

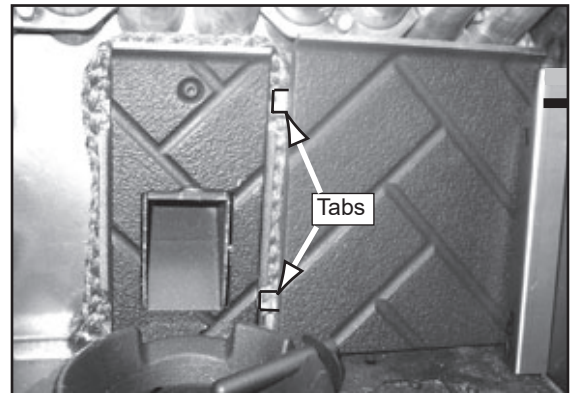

Figure 27.4

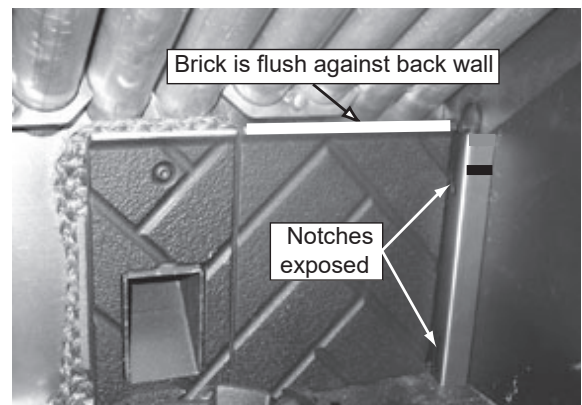

Figure 27.5

Re-installing Baffle & Brick Set (Cont'd)

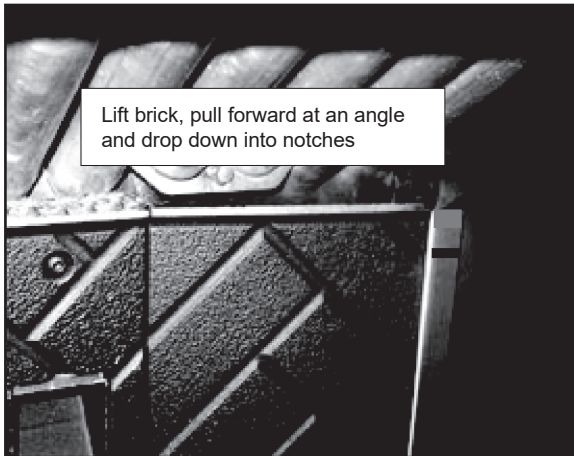

Figure 28.1

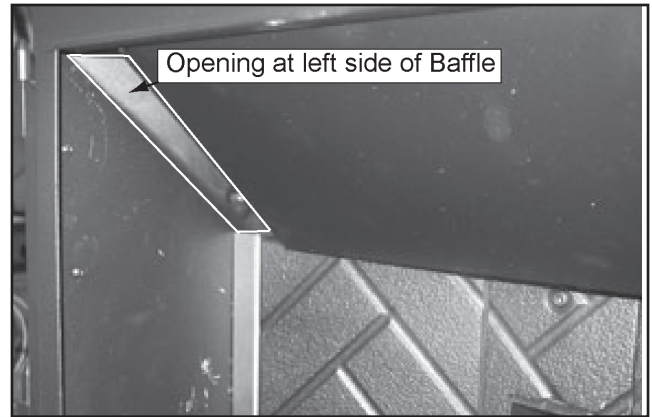

Figure 28.4



Figure 28.2

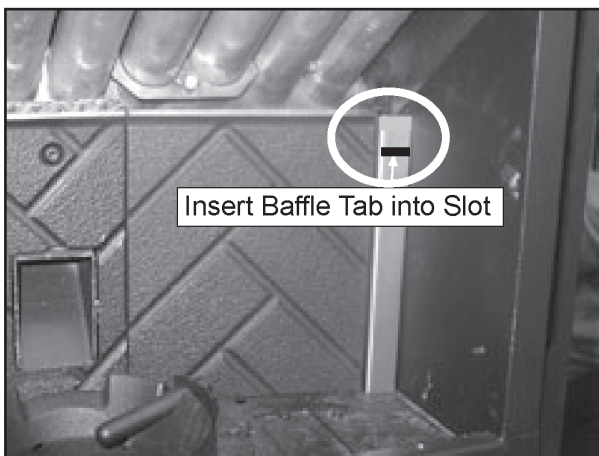

Figure 28.3

D. Igniter Replacement

1. Shut down the appliance by turning down the thermostat and let the appliance completely cool down. After the appliance has cooled down, unplug it and remove the ash drawer.
2. The wire leads to the igniter are connected to the wire harness with 1/4 inch (6mm) male / female spade connectors. These wires will pull forward approximately 4 to 5 inches (102mm to 127mm) through the grommet at the back of the ash drawer chamber. Disconnect the spade connections and remove the igniter from the chamber. Loosen the thumb screw and slide igniter out.
3. Install new igniter into the chamber and tighten the thumb screw. Re-connect the wires to the 2 leads with the spade connectors.
4. Push excess wire leads back through the grommet, one wire at a time, to take-up the 4 to 5 inches (102mm to 107mm) previously pulled out. This will keep the wires out of the way of the ash drawer. Double check that the igniter wires are clear of any movement, i.e. ash drawer, fire pot cleaning rod, cleaning slide plates, etc.
5. Re-install the ash drawer and then re-install the side panel and re-connect the power.

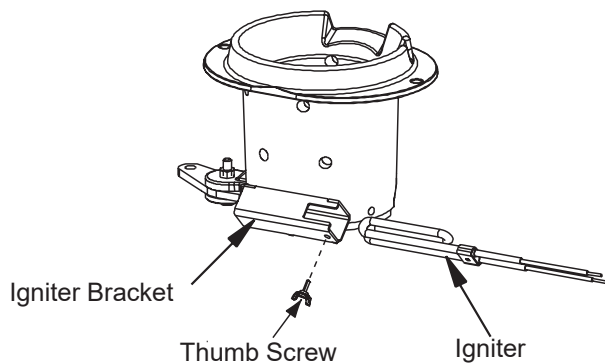

Figure 29.1

E. Glass Replacement

1. Open the face and remove door from the appliance by lifting door off of hinge pin and lay on a flat surface face down.
2. Using a screwdriver, tap the bottom of the rope retainer rod to push it up out of the hole. The top end of the rod will slide up. Swing the rod toward you from the bottom and remove the rod. Repeat for other side.
3. Remove old glass and replace with new glass.
4. Slide the retainer rod into the top hole first, and then line up the bottom crimped end with the hole in the door. The crimped end must be parallel with the glass in order to insert it into place (**Figure 29.2**).

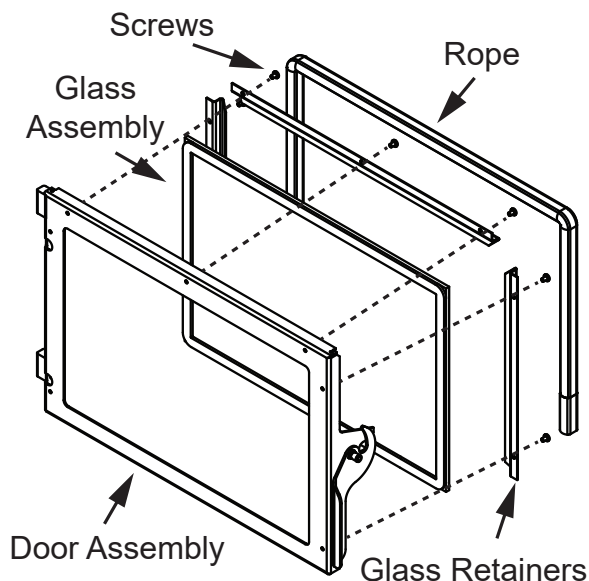



Figure 29.2

WARNING	
	
	<ul style="list-style-type: none"> • Glass is 5mm thick high temperature heat-resistant ceramic glass. • DO NOT REPLACE with any other material. • Alternate material may shatter and cause injury.

6 Reference Materials

A. Component Functions



When describing the location of a component, it is always AS YOU FACE THE FRONT OF THE APPLIANCE.

1. Control Box

- The control box is located on lower right side of appliance, on top of the junction box.
- There is a light located inside of the control box. The internal light will turn green when the appliance has reached a temperature of 200°F (93°C) in the fire pot. and will turn red when it reaches 600°F (315°C).
- There is also an internal blue light located in the upper left corner of the control box. When you plug in the appliance the blue light will automatically start blinking 6 blinks every 10 seconds for 60 seconds (depending upon setting) and then will stop.

NOTE:

Do **NOT** open the control box. This will void the warranty. If you need to plug in or remove the control box you must first **unplug the appliance.**

2. Convection Blower

The convection blower is mounted at the bottom rear of the appliance. There are 2 impellers, one on each side of the motor. The convection blower pushes air through the heat exchange system into the room.

3. Exhaust Blower

The exhaust blower is mounted on the right side of the appliance behind the right side panel. The exhaust blower is designed to pull the exhaust from the appliance and push it out through the venting system.

4. Feed System

The feed system is located behind the firebox and can be removed as an entire assembly. The assembly includes the feed motor, mounting bracket, bearing and feed spring (auger). The hollow feed spring (auger) pulls pellets up the feed tube from the hopper area and drops them down the feed chute into the fire pot at a set rate. The feed motor starts and stops every 7 seconds.

5. Fire pot

The fire pot is made of high quality ductile iron and has a cleaning pull-out rod. The floor of the fire pot opens for cleaning when you pull out the rod. Be sure that the floor returns to a completely closed position or your appliance will not operate properly.

6. Fuse

The fuse is located on the side of the junction box near the red call light. The fuse will blow should a short occur and shut off power to the appliance.

7. Heat Exchangers

The heat exchangers transfer heat from the exhaust system into convection air. There are 2 clean out rods located under the heat exchangers.

8. Heat Output Switch

The heat output switch is located on the lower right side of firebox, behind the front access door and above the reset button. The function of the heat output switch is to regulate the burn rates; low, medium and high settings.

9. Hopper Switch

The hopper switch is located in the upper right hand corner, outside of the hopper. This switch is designed to shut down the feed motor whenever the hopper lid is opened.

10. Igniter

The igniter is mounted on the base of the fire pot. Combustion air travels over the red hot igniter creating super heated air that ignites the pellets.

11. Junction Box And Wiring Harness

The junction box is located on the lower right side of the appliance, behind the left front access door. The junction box and wiring harness are replaced as one component.

12. Power Supply

The power outlet is located on the lower right side of the appliance on the front of the junction box. Check the wall receptacle for 120 volt, 60 Hz (standard current). Make sure the outlet is grounded and has the correct polarity. A good surge protector is recommended. When operating with a generator you need a least 600 watts of power, or with an inverter at least 800 watts of power available for the appliance during the start cycle.

13. Red Call Light

The red call light is on the top of the junction box by the fuse. The function of the red call light is to indicate that the thermostat is calling for heat.

14. Reset Button

The reset button is located on the lower right side of firebox in behind the access door and below the heat output control switch. The function of the switch is to momentarily open the thermostat circuit, which restarts the system.

15. Thermocouple

The thermocouple is located on top of the fire pot inside the thermocouple cover (ceramic protection tube). The thermocouple sends a millivolt signal to the control box indicating the preset temperatures of the green and red lights have been obtained.

16. Thermostat

The appliance is designed to run on a 5 volt DC thermostat. The heat anticipator, if present, should be set on the lowest setting available.

17. Snap Disc #1 (Convection Blower) 110°F

Snap disc #1 is located on the right side of the firebox. There are 2 purple wires connected to it. This snap disc turns the convection blower on and off as needed. Power is always present at snap disc #1 if the appliance is powered up.

18. Snap Disc #2 (Fuel Delivery Interrupt) 250°F

Snap disc #2 is located on the back side of the feed drop tube. There is 1 orange wire and 1 black wire connected to it. This snap disc will turn off the feed system, which will turn off the appliance if an over fire condition should occur or if the convection blower should fail to operate. If this occurs the snap disc will automatically reset itself.

19. Snap Disc #3 (Burn Back Protector) 250°F

Snap disc #3 is mounted on the back of the auger tube in the center of the appliance and has a reset button. To access it remove the right side panel. If the fire tries to burn back into the feed system or push exhaust up the feed tube, this snap disc will shut the entire system off. This disc must be manually reset. Power is always present at snap disc #3 if the appliance is powered up.

20. Vacuum Switch

The vacuum switch is located on the lower right side of the appliance behind left access panel. This switch turns the feed system on when vacuum is present in the firebox. The vacuum switch is a safety device to shut off the feed motor if the exhaust or the heat exchanger system is dirty or plugged or if the firebox door is open.

21. Wiring Schematic

See Figure 31.1 below

The power outlet is located on the right rear of the appliance beneath the heat output switch and reset button.

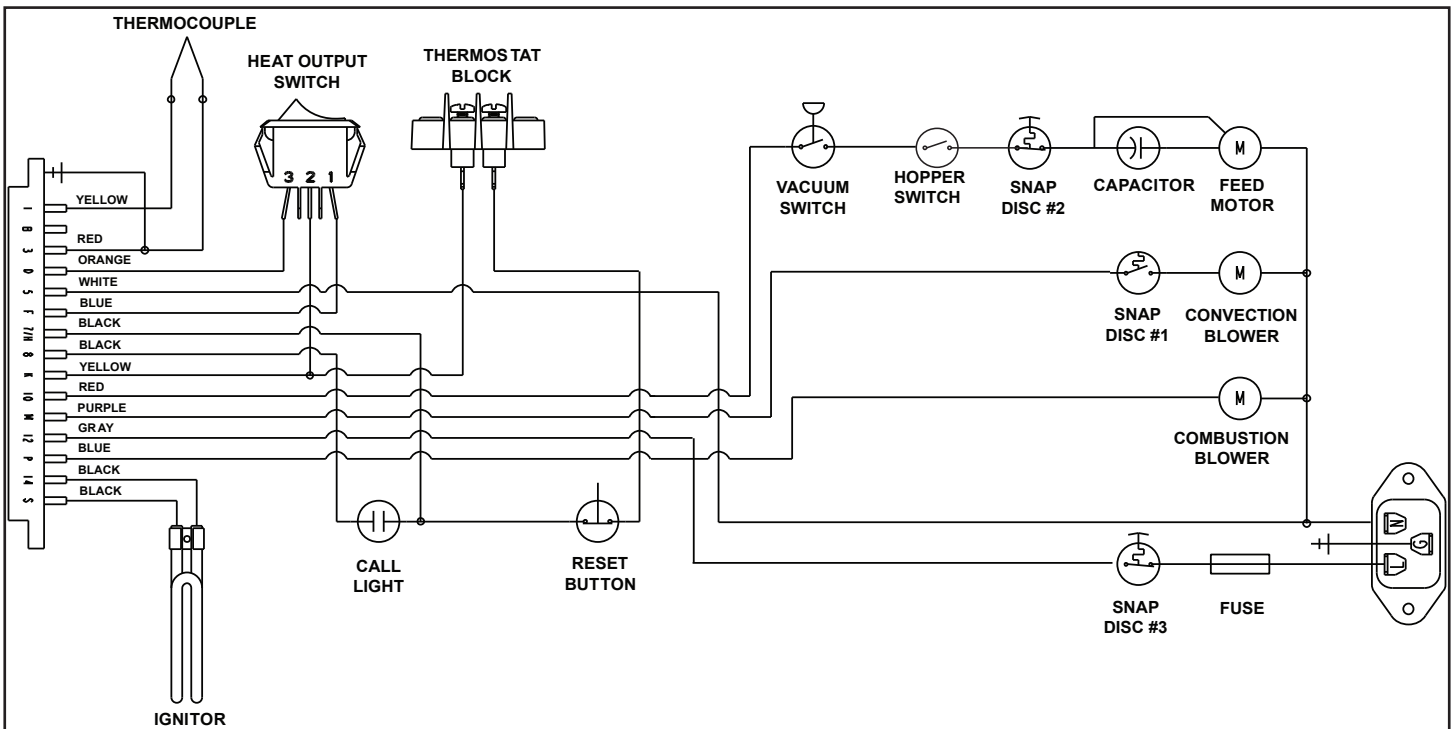

Figure 31.1

B. Component Locations

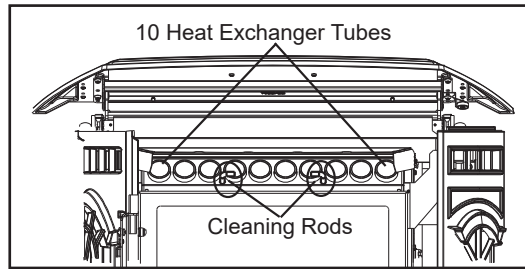

Figure 32.1 - Cleaning Rods & Heat Exchanger Tubes

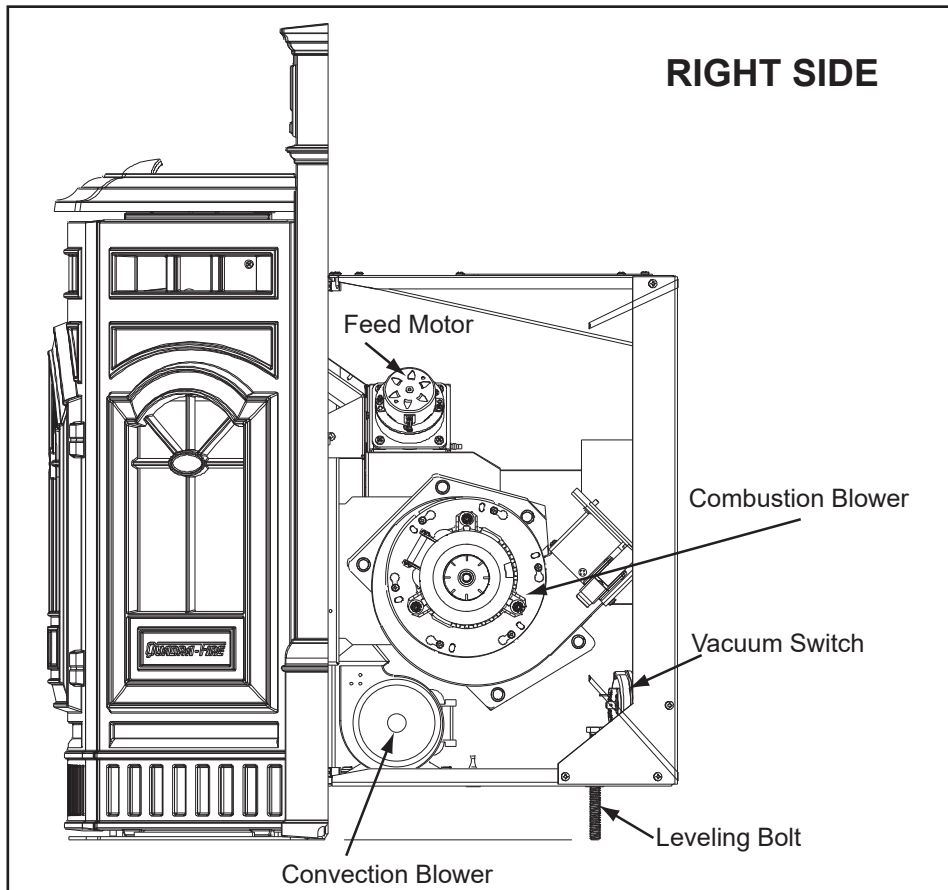

Figure 32.2

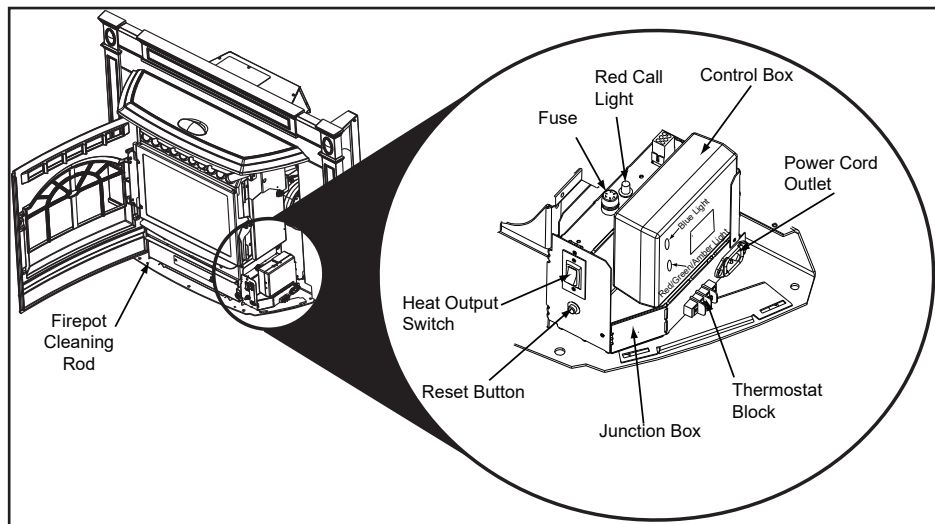

Figure 32.3

C. Service and Maintenance Log

Date of Service	Performed By	Description of Service

CASTILE INSERT

Date of Service	Performed By	Description of Service

D. Exploded Drawings

E. Service Parts List

F. Accessories

QUADRA-FIRE®

NOTHING BURNS LIKE A QUAD

CONTACT INFORMATION

Hearth & Home Technologies
352 Mountain House Road
Halifax, PA 17032
Division of HNI INDUSTRIES

Please contact your Quadra-Fire dealer with any questions or concerns.
For the number of your nearest Quadra-Fire dealer
log onto www.quadrafire.com



CAUTION



DO NOT DISCARD THIS MANUAL

- Important operating and maintenance instructions included.
- Read, understand and follow these instructions for safe installation and operation.
- Leave this manual with party responsible for use and operation of this appliance.



We recommend that you record the following pertinent information for your heating appliance.

Date purchased/installed: _____

Serial Number: _____

Location on appliance: _____

Dealership purchased from: _____

Dealer Phone: 1() - _____

Notes:

This product may be covered by one or more of the following patents: (United States) 5341794, 5263471, 6688302, 7216645, 7047962 or other U.S. and foreign patents pending.

HEARTH & HOME
technologies™