



PP150 Pellet Stove

Owner's Manual

⚠ WARNING!

Please read this entire manual before installation and use of this pellet fuel-burning room Stove, and save for future reference. Failure to follow these instructions could result in property damage, bodily injury or even death. Contact local building or fire officials about restrictions and installation inspection requirements in your area.

Note: To obtain a French translation of this manual, please contact your dealer or visit www.pelprostoves.com. Pour obtenir une traduction française de ce manuel, s'il vous plait contacter votre revendeur ou visitez www.pelprostoves.com

Get to Know Your PelPro® Stove

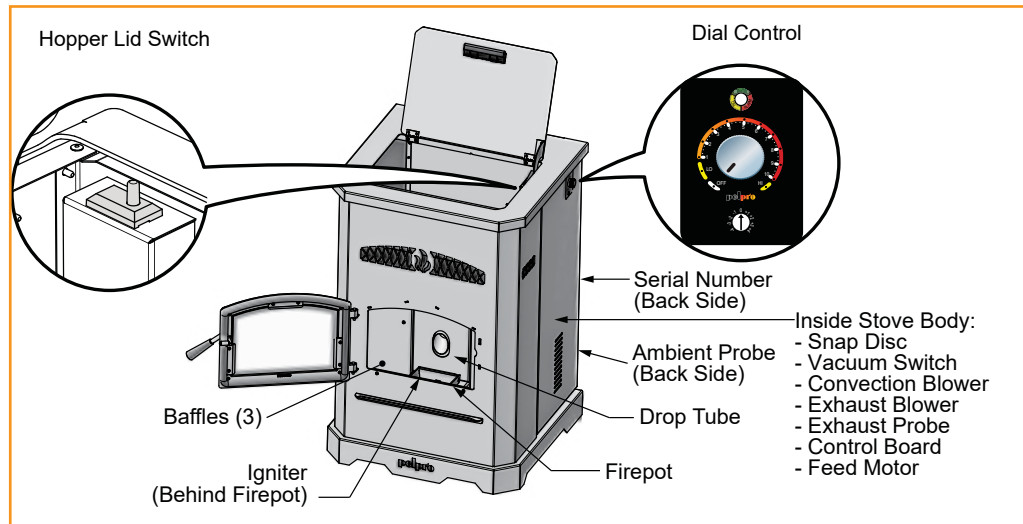

Safety First!

Safety Alert Key: It is important to pay attention to alerts you will see throughout this manual to ensure your safety.

- **DANGER!** Indicates a hazardous situation which, if not avoided will result in death or serious injury.
- **WARNING!** Indicates a hazardous situation which, if not avoided could result in death or serious injury.
- **CAUTION!** Indicates a hazardous situation which, if not avoided, could result in minor or moderate injury.
- **NOTICE:** Indicates practices which may cause damage to the Stove or to property.
- **Pro Tip:** Indicates additional information to help you better understand your Stove and optimize its performance.

NOTICE:

Fire Risk

Pelpro disclaims any responsibility, and the warranty and agency listing will be voided, by the below actions.

DO NOT:

- Install or operate damaged Stove
- Modify Stove
- Install other than as instructed by the manufacturer
- Operate the Stove without fully assembling all components
- Over fire (burning at higher temperatures than recommended causing permanent damage to the Stove)
- Install any component not approved by the manufacturer
- Install parts or components not listed or approved
- Disable safety switches



Improper installation, adjustment, alteration, service or maintenance can cause injury or property damage. For assistance or additional information, consult a qualified installer, service agency or your dealer.

DANGER!

HOT SURFACES!

Glass and other surfaces are hot during operation AND cool down.

Hot glass will cause burns.

- Do not touch glass until it is cooled
- NEVER allow children to touch glass
- Keep children away; if you expect that children may come into contact with this Stove, we recommend a barrier such as a decorative screen (see your retailer for suggestions)
- CAREFULLY SUPERVISE children in same room as Stove
- Alert children and adults to hazards of high temperatures



High temperatures may ignite clothing or other flammable materials.







- Keep clothing, furniture, draperies and other flammable materials away

WARNING

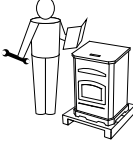
This product and the fuels used to operate this product (wood), and the products of combustion of such fuels, can expose you to chemicals including carbon black, which is known to the State of California to cause cancer, and carbon monoxide, which is known to the State of California to cause birth defects or other reproductive harm. For more information go to: WWW.P65Warnings.ca.gov

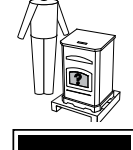

Table of Contents

	<ul style="list-style-type: none"> • Get to Know Your Stove • California - Prop65 	
	Getting Started <ul style="list-style-type: none"> • Pallet Removal • What's Included • What You'll Need 	4
	Installing Your Stove <ul style="list-style-type: none"> • Getting Ready • Vent Termination Clearances • Placing Your Stove • Venting Your Stove 	6
	Using Your Stove <ul style="list-style-type: none"> • Fuel Tips • Starting your Stove the first time • Starting your Stove from an empty hopper • What Do the Blinking Lights Mean? • Comfort Settings • Trim Adjustment • Turning Your Stove Off 	14
	Maintaining Your Stove <ul style="list-style-type: none"> • Cleaning & Maintenance • What You'll Need • Where, When and How 	21
	Replacement Parts <ul style="list-style-type: none"> • Power Related • Blockage Related • Warranty 	25
	Troubleshooting <ul style="list-style-type: none"> • Power Related • Blockage Related • Warranty 	29
	Support <ul style="list-style-type: none"> • Contact information • Ordering Parts 	35
	Listings and Certifications <ul style="list-style-type: none"> • Stove Certification • Mobile Home Approved • Glass Specifications • Electrical Rating (On High) • BTU & Efficiency Specifications • Stove dimensions • Warranty 	36
	Reference Materials <ul style="list-style-type: none"> • Wiring Schematic for Control Board • Service Part List • Maintenance Log 	39

Getting Started

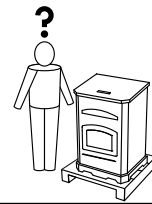

Pallet Removal

There are bolts holding your PelPro Stove in place on the pallet. To remove your Stove from the pallet:



Pallet Removal
Visit pelprostoves.com
or scan the code:



1
Loosen the three retaining bolts on the back of the Stove and remove the right and left side panels.

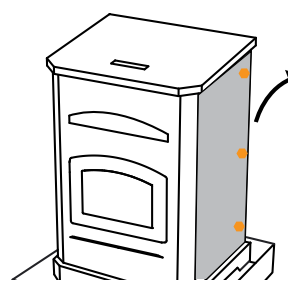

2
Using a 5/16 inch wrench, on each side of the Stove remove the two bolts.

Remove shipping brackets by reaching into Stove in the same area as the just removed bolts.

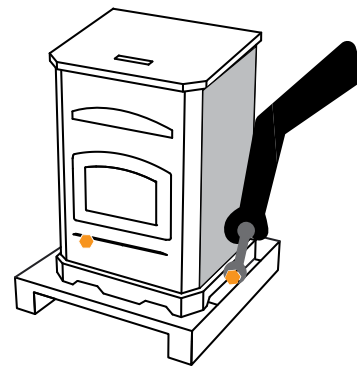

WARNING!

Inspect Stove and components for damage. Damaged parts may impair safe operation.

- Do NOT install damaged components.
- Do NOT install incomplete components.
- Do NOT install substitute components.

Report damaged parts to dealer.

CAUTION!

Risk of cuts, abrasions or flying debris. Wear protective gloves & safety glasses during install. Metal edges are sharp.

What's Included



Owner's manual

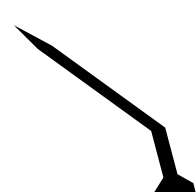

Cleaning tool

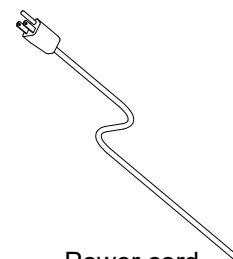

Power cord

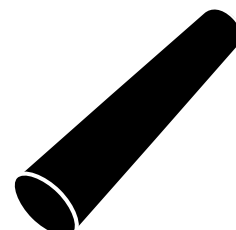

Door handle



Online Installation & Trouble Shooting Videos

Outside air kit components:



2" Flex hose

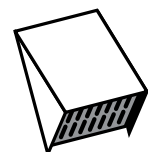

Termination Cap

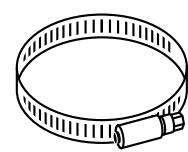

Hose clamp

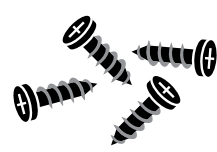

Screws (4)

Getting Started

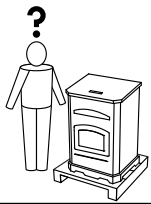

What You'll Need

Tools & Supplies

- High temperature silicone (500°F+)
- Level
- Phillips screwdriver
- Plumb line
- Tape measure
- Framing square
- Reciprocating saw
- Electric drill & bits
- Caulking gun
- Stud finder
- Utility knife
- Pliers
- Flashlight
- Hammer

Safety Equipment

Recommended for all installation and maintenance steps.



Gloves



Safety glasses



Close-toed shoes

Pellet Vent Pipe

Must be an approved 3" or 4" diameter Type "L" or "PL" vent. Use 4" diameter vent if flue height is over 15' or if installation is over 3,000ft. above sea level.



WARNING!

Fire Risk. NO OTHER vent components may be used. Substitute or damaged vent components may impair safe operation.

Floor Protection

Non-combustible material (such as a hearth pad) is required underneath your Stove.

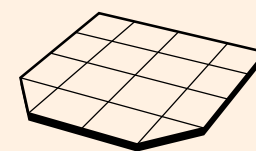

Surge Protector

Protect the electrical components of your Stove by using a surge protector.

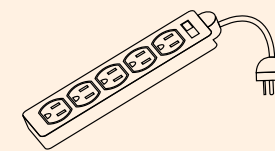

Pellet Fuel

Use only wood pellets in your Stove. For best performance, use premium, low-ash pellets (<1% less than 1.5" in length and avoid the dusty bits and pieces of pellets in the bottom of the bag.



Installing Your Stove

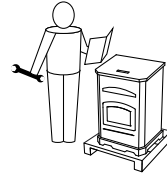

Getting Ready

Pro Tip

We highly recommend your Stove and pellet vent pipe be installed by a professional installer. Your retailer can make recommendations for you. Installation MUST comply with local, regional, state and national codes and regulations. Consult insurance carrier, local building inspector, fire officials or authorities having jurisdiction over restrictions, installation inspection and permits.

Placement

Where you place your Stove can significantly affect its performance and safety.

A Your Home Acts Like a Chimney

- We recommend that you help your home by:
1. Using a minimum of 5 feet of vertical venting
 2. Use the supplied outside air kit
 3. Install your Stove on a main floor location

This will:

- Help your Stove breathe
- Minimize smoke leakage in the house
- Enhance performance

Clearance to Combustibles

The space between your Stove and the items in your home that could burn. Materials such as:

- Wood
- Sheet rock (drywall)
- Carpet

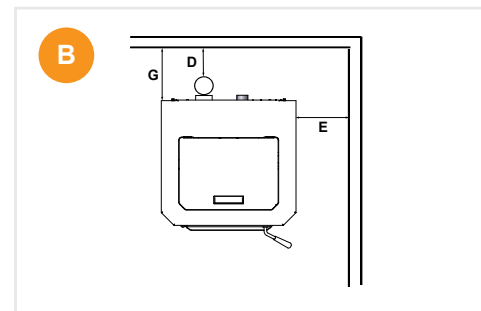
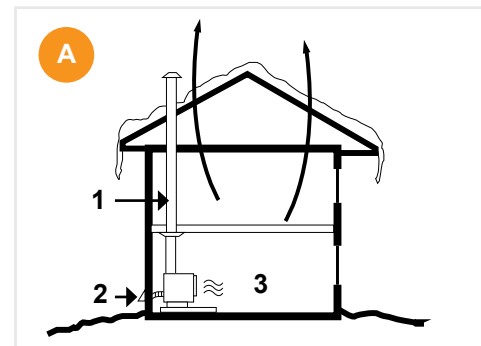

WARNING!

Asphyxiation Risk.
DO NOT INSTALL IN A SLEEPING ROOM. Consumes oxygen in the room.

For Canada, the installation must conform to CAN/CSA-B365

Installing Your Stove

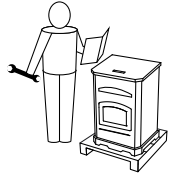

Getting Ready (Continued)

C

Pellet Venting

Adding bends in the exhaust path restricts air flow, reduces performance and provides a collection point for ash deposits requiring more frequent cleaning.

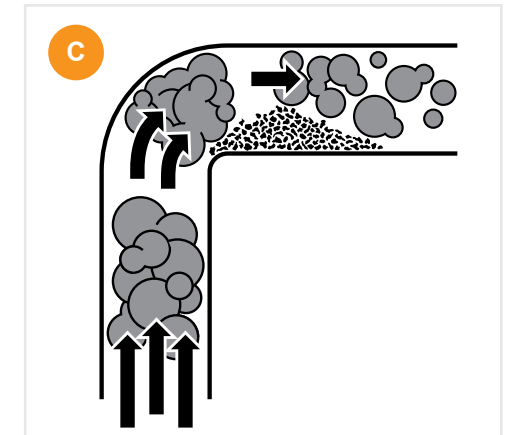

CAUTION

- Do not connect to any air distribution duct or system
- Do not install a flue damper in the exhaust venting system of this Stove
- Do not connect this Stove to a chimney flue serving another Stove
- The structural integrity of the manufactured home floor, wall and ceiling/roof must be maintained

REQUIRED:

Use only 3" or 4" type "L" or "PL" pellet pipe.

Pro Tip

This Stove can be installed with a 3 to 6 inch (76-152mm) Top Vent Offset Adapter Kit. The 3 to 6 inch (76-152mm) Top Vent Offset Adapter are tested to use 24 gauge single wall flue connector or Listed double wall flue connector to Class A Listed metal chimneys, or masonry chimneys meeting International Conference of Building Officials (ICBO) standards for solid fuel Stoves.

Caution, do not pass connector pipe through a combustible wall or ceiling. Please refer to connector pipe installation instructions for details.

Installation Video



Visit pelprostoves.com or scan this code:



Installing Your Stove

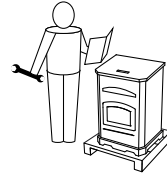

Vent Termination Clearances

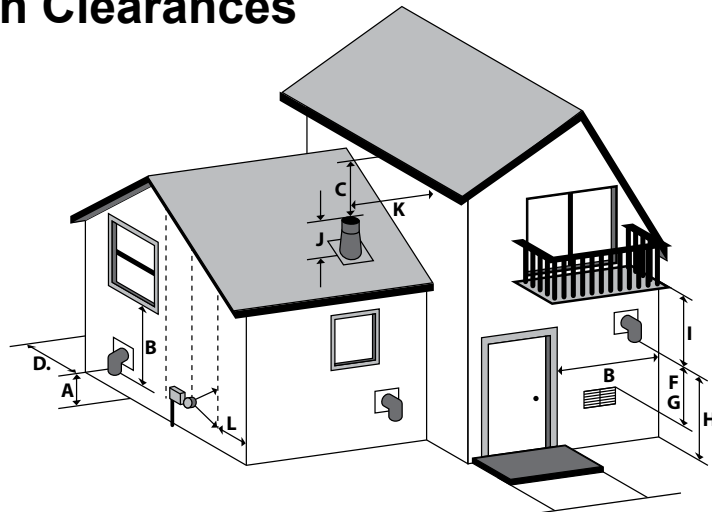

	Clearances	
A	12"	Clearance above grade, veranda porch, deck or balcony (Including vegetation and mulch)
B	12"	Clearance beside or below any windows or doors that open
	12**	Clearance above any window or door that opens
C	18"	Vertical clearance to ventilated soffit located above the terminal within a horizontal distance of 2 feet from the center line of the terminal
D	12"	Clearance to an outside corner wall
F	12", 48" no outside air kit	Clearance to a non-mechanical air supply inlet to the building or a combustion air inlet to any other Stove
G	36"	Clearance to a mechanical air supply inlet
H	84***	Clearance above a paved sidewalk or paved driveway located on public property
I	12***	Clearance under a veranda, porch, deck or balcony
J	12"	Clearance above the roof
K	24"	Clearance from an adjacent wall including neighboring buildings
L	36" within a height of 15 feet above the meter / regulator assembly	Clearance to each side of center line extended above natural gas or propane meter / regulator assembly or mechanical vent

*Recommended to prevent condensation on windows and thermal breakage. **This is a recommended distance. For additional requirements check local codes.

NOTICE:
Do NOT terminate vent:

- In any location that will allow flue gases or soot from entering or staining the building
- In any location which could create a nuisance or hazard
- In any enclosed or semi-enclosed area such as a carport, garage, attic, crawl space, under a sun deck or porch or narrow walkway
- Closely fenced area, or any location that can build up a concentration of fumes such as a stairwell, covered breezeway, etc.

NOTICE:
Do NOT terminate below an air inlet.

- It is recommended that at least 60" (1.52m) of vertical pipe be installed when Stove is vented directly through a wall—this will create a natural draft, which will help prevent the possibility of smoke or odor venting into the home during a power outage
- It will also keep exhaust from causing a nuisance or hazard by exposing people or shrubs to high temperatures
- The safest and preferred venting method is to extend the vent vertically through the roof or above the roof

Installing Your Stove

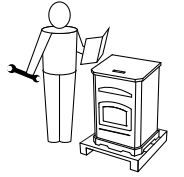

Placing Your Stove

- 1 It is necessary to install **EMBER PROTECTION**; a Type 1 floor protector for this Stove. The Floor protector must be non-combustible material, extending beneath Stove with a minimum of 6 inches (152mm) in front of glass and 6 inches (152mm) to both sides of the fuel loading door. Open the door and measure 6 inches (152mm) from the side edge of the opening in the face of the Stove.

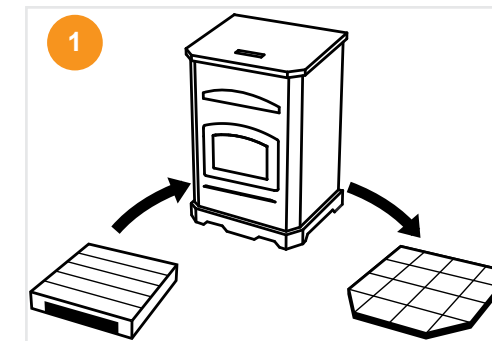

Notice: Be careful to protect the bottom of the Stove and floor surfaces when moving the Stove. Bottom edges of Stove are sharp and can scratch surfaces.

Notice: Clearances may only be reduced by means approved by the regulatory authority having jurisdiction.

- 2 Hearth pad minimum requirements:

USA Hearth Pad Requirements		Inches	mm
A	Sides	2	51
B	Back	2	51
C	Front	6	152

Canada Hearth Pad Requirements		Inches	mm
A	Sides	6	152
B	Back	2	51
C	Front	6	152

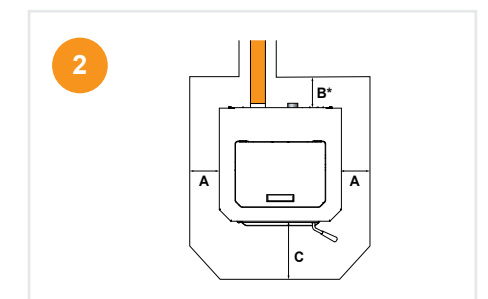

Non-combustible floor protection extending beneath the flue pipe is required with horizontal venting or under the top vent adapter with vertical installation.

*Non-combustible floor protection must extend 2 inches (51mm) beneath the flue pipe when installed horizontal venting or under the top vent adapter with vertical installation. CANADA REQUIRED, USA RECOMMENDED.

Installing Your Stove

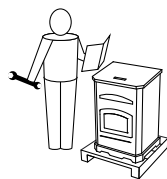

Installing Your Stove

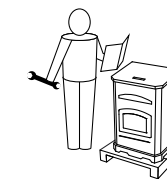

Installing Your Stove

Installing Your Stove

3 Confirm required clearances to combustibles:

Vertical Installations (Interior Flue)			
Straight back against wall			
	Inches	mm	
D	Back wall to pellet pipe	3	76
E	Side wall to Stove	9	229
Corner Installation			
Straight back against wall			
	Inches	mm	
F	Walls to Stove	3	76
Horizontal Installations			
Straight back against wall			
	Inches	mm	
G	Back wall to Stove	3	76
E	Side wall to Stove	9	229

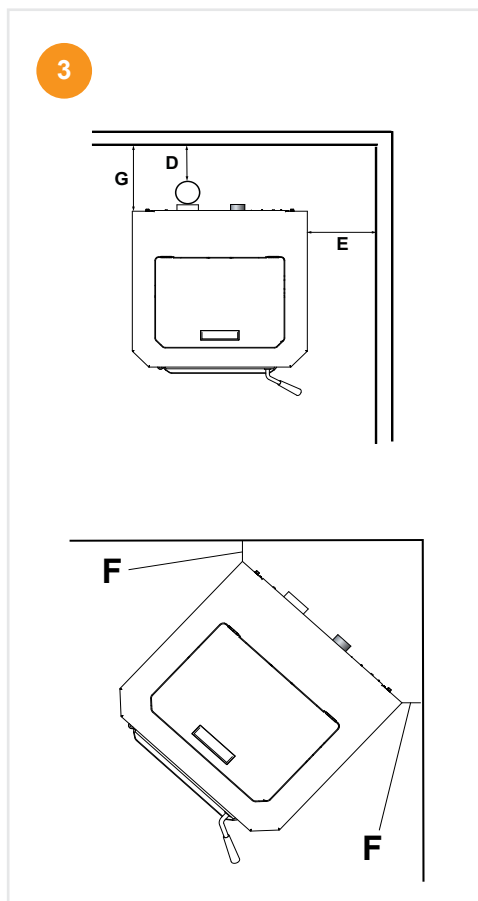

4 Alcove:

		Minimum*		Maximum	
		Inches	mm	Inches	mm
H	Height	52	1321	n/a	n/a
I	Width	42-1/2	1080	n/a	n/a
J	Depth**	n/a	n/a	25-3/4	654

*All minimums listed are to a combustible surface.

**Front of stove must be flush or extend past the alcove front.

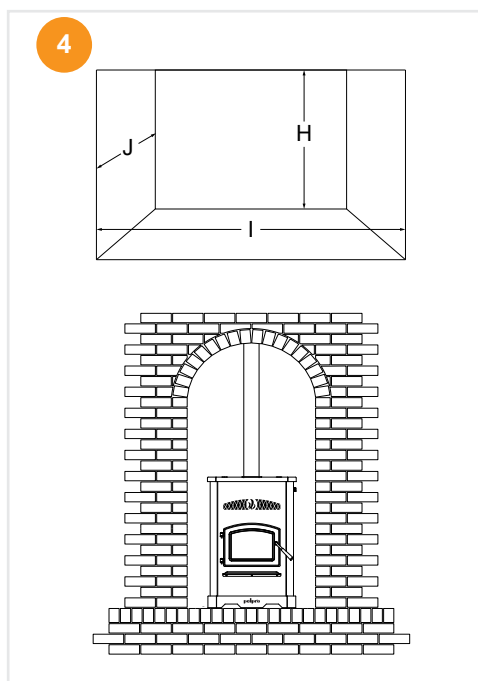

Venting Your Stove

CAUTION!

Take appropriate precautions to locate utilities within the wall and avoid contact.

- 1 Mark and cut wall for venting penetration on exterior wall (if needed).
- 2 Install wall thimble (sold separately) per manufacturer requirements.
- 3 Install venting. (For additional installation options visit pelprostoves.com)
- 4 Use silicone to create an effective vapor barrier at the location where the chimney or other component penetrates to the exterior of the structure.

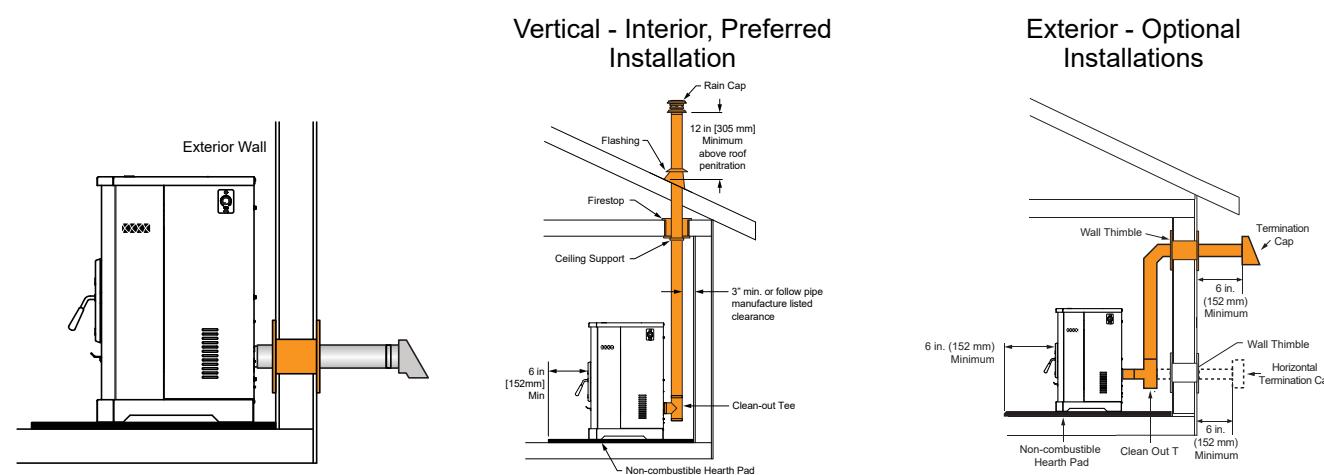

NOTE: In Canada when using a factory-built chimney it must be safety listed, Type UL103 HT (2100°F) CLASS "A" or conforming to CAN/ULC-S629M, STANDARD FOR 650°C FACTORY-BUILT CHIMNEYS.

Pro Tips

- See venting manufacturer's required clearances to combustibles
- For horizontal installations, the minimum clearance from exterior to termination cap is 6"—you may want to increase to 18" clearance to minimize soot blow back on home exterior.

Install vent at clearances specified by the manufacturer

WARNING!

Do not terminate venting in any enclosed or semi-enclosed area such as: a carport, garage, attic, crawl space, under a sun deck or porch, narrow walkway or closely fenced area, or any location that can build up a concentration of fumes such as a stairwell, covered breezeway, etc.

CAUTION!

Ensure that your Stove venting terminates above your Stove. The following may occur:

- Your Stove will not draft properly
- Smoke may seep in your house
- Excessive sooting

Installing Your Stove

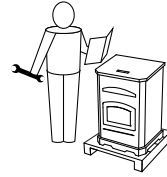

Venting Your Stove

The maximum horizontal venting allowed with no vertical venting attached is 48 inches including one 90° elbow or two 45° elbows. Addition of any horizontal venting beyond 48 inches requires a minimum 60 inches of additional vertical vent. Horizontal sections of vent pipe should have a 1/4 inch rise per foot. We recommend using the shortest venting and fewest elbows possible when venting horizontal.

We recommend the use of 4 inch vent with any installation requiring more than two 90° elbows, or more than 15 feet of venting.

- 45° elbow is equivalent to 1 foot of straight pipe
- 90° elbow is equivalent to 3 feet of straight pipe

⚠ WARNING!

Fire Risk.

- Only LISTED venting components may be used
- NO OTHER vent components may be used. Substitute or damaged vent components may impair safe operation.



Notice:

These are guidelines for successful venting of your pellet Stove. The more vertical rise you can obtain in your system, the better it will perform. Horizontal vent runs can accumulate ash and will need to be cleaned more often. Try to keep them as short as possible.

ONE 90° ELBOW		
Total Horizontal	Minimum Vertical	Vent Diameter
4	0	3
5	5	3
6	6	3
7	7	3
8	8	4
9	9	4
10	10	4
11	11	4
12	12	4
13	13	4
14	14	4
15	15	4
16	13	4
17	17	4
18	18	4
19	19	4

TWO 90° ELBOWS		
Total Horizontal	Minimum Vertical	Vent Diameter
2	5	3
3	6	3
4	7	3
5	8	3
6	9	3
7	10	4
8	11	4
9	12	4
10	13	4
11	14	4
12	15	4
13	16	4
14	17	4
15	18	4

THREE 90° ELBOWS		
Total Horizontal	Minimum Vertical	Vent Diameter
2	11	4
3	12	4
4	13	4
5	14	4
6	15	4
7	16	4
8	17	4
9	18	4
10	19	4
11	20	4

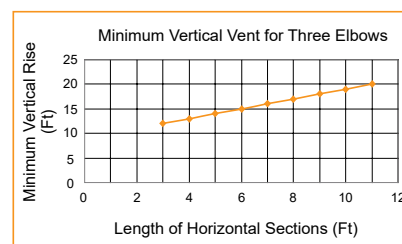
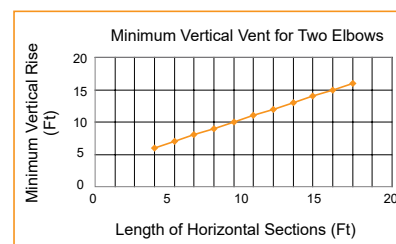
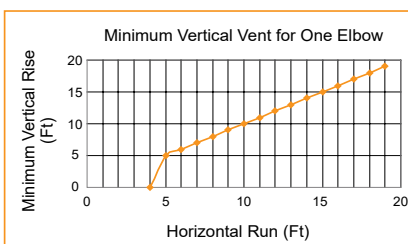

Installing Your Stove

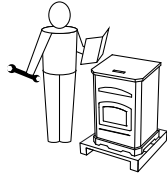

- Install pellet venting through wall and connect vent/pipe to Stove **A**
 - Some venting manufacturers offer pellet Stove adapters for their venting for easier installation
 - Seal all pipe joints using high-temp silicone (500°+)
 - Secure exhaust venting system to the Stove with at least 3 screws or rivets per the pipe manufacturer's instructions. Also secure all connector pipe joints with at least 3 screws through each joint.
 - Install termination cap
 - Confirm all required Stove clearances to combustibles

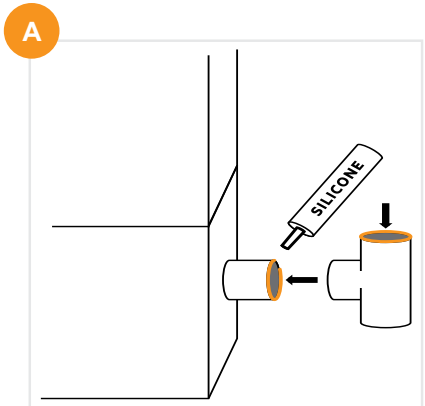

Pro Tip

Installing a clean-out "T" (sold separately) to the rear of your Stove, when venting vertically can save time during cleaning.

- Install outside air kit (included)
 - For optimal performance, PelPro recommends the outside air kit for all installations. Outside air kit is required for all mobile/manufactured home installations.

Install through wall **B**

- Maintain clearances from exhaust
 - Attach flex pipe to outside air connection on Stove
 - Use hose clamp
 - Route tube outside the structure
 - Attach cap
 - Secure to outside wall with appropriate fasteners

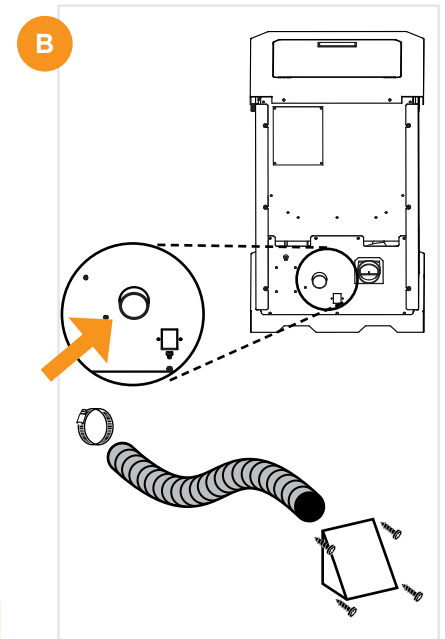

Take a Break

Inspect your work:

- ___ Confirm clearances to combustibles are maintained
- ___ Pipe joints are secure and properly sealed
- ___ Outside air kit installed properly
- ___ Confirm termination clearances



⚠ CAUTION!

Never draw outside combustion air from:

- Wall, floor or ceiling cavity
- Enclosed space such as an attic, garage or crawl space.

Using Your Stove

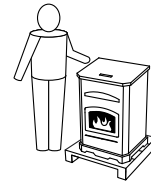

Fuel Tips

Fuel Material and Fuel Storage

Pellet fuel quality can greatly fluctuate. We recommend that you buy fuel in multi-ton lots whenever possible. However, we do recommend trying various brands before purchasing multi-ton lots to ensure your satisfaction. Store fuel in dry location not within clearances to combustibles of your Stove.

Fuel Material

- Made from sawdust or wood by-products
- Depending on the source material it may have a high or low ash content.

Higher Ash Content Material

- Hardwoods with a high mineral content
- Fuel that contains bark
- Standard grade pellets or high ash pellets

Lower Ash Content Material

- Most softwoods
- Fuels with low mineral content
- Most premium grade pellets

Pro Tip

We recommend the use of Pellet Fuels Institute certified pellet fuel with this product.



Your Stove has a manufacture-set minimum low burn rate that must not be altered. It is against federal regulations to alter this setting or otherwise operate your Stove in a manner inconsistent with operation instructions in this manual.

Using Your Stove

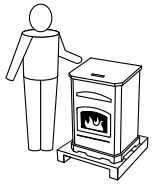

Starting your Stove the first time

What to Expect

- 1 Combustion blower will turn on
- 2 Igniter will turn on
- 3 Pellets will drop, smoke may occur in firebox but will evacuate, and flame will appear in fire pot.
- 4 Convection blower will automatically turn on after the Stove heats up. Convection blower will continue to run even after your Stove has been shut down.

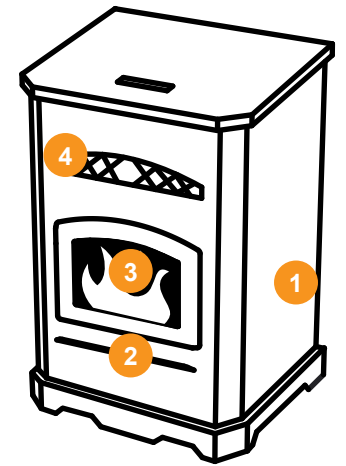

Pro Tips

- Odors and vapors are released during initial startup after purchase; burning your Stove on HI for 30 minutes will allow the paint to cure. Open windows or doors for air circulation until burn off is complete.
- During start up and normal operation your Stove's front door must be closed
- Priming is only required the first time your Stove is lit, or after a FUEL FEED ALARM.

⚠ WARNING! Fire Risk



Keep combustible materials, gasoline and other flammable vapors and liquids clear of Stove.

- Do NOT operate Stove with door open
- Do NOT operate Stove with fire pot floor open
- Do NOT store flammable materials in the Stove's vicinity
- Do NOT use gasoline, lantern fuel, kerosene, charcoal lighter fluid or similar liquids or gels to start or "freshen up" a fire in this Stove

Keep all such liquids well away from the Stove while it is in use as combustible materials may ignite.

⚠ WARNING!

HOT SURFACES! Glass and other surfaces are hot during operation AND cool down.

Hot glass will cause burns.



- Do not touch glass until it is cooled
- NEVER allow children to touch glass
- Keep children away
- CAREFULLY SUPERVISE children in same room as fireplace
- Alert children and adults to hazards of high temperatures
- High temperatures may ignite clothing or other flammable materials
- Keep clothing, furniture, draperies and other flammable materials away

Using Your Stove



Use and Care
Visit pelprostoves.com or scan this code:



Important:
Allow up to 20 minutes for your Stove to start.

1 Confirm fire pot is properly positioned

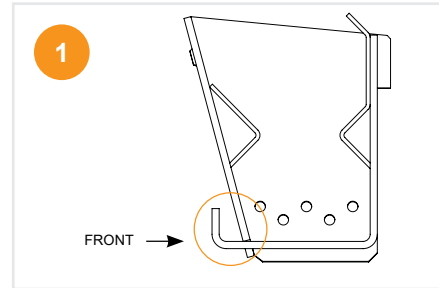

2 Confirm three baffles inside firebox are secure, placing the side baffles before the center

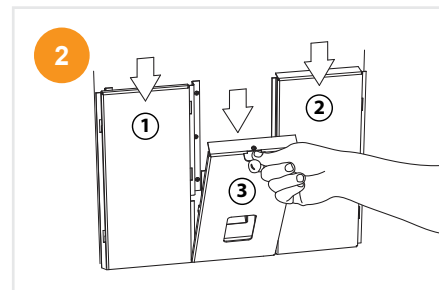

3 Add some pellets to hopper and fully close lid

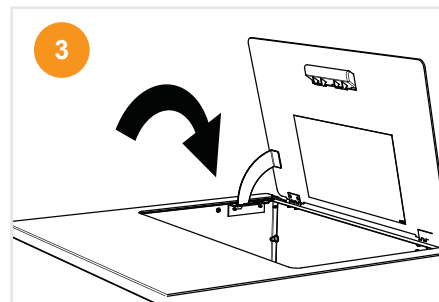

4 Ensure dial control is set in off position.

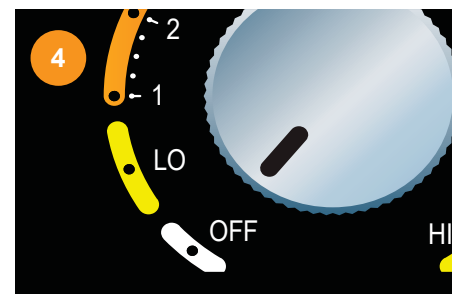

- WARNING!** Shock hazard.
- Plug directly into properly grounded 3 prong receptacle
 - Do NOT route cord under or in front of Stove
 - Recommend the use of a surge protector

Using Your Stove



Starting your Stove from an empty hopper

5 Plug in your Stove

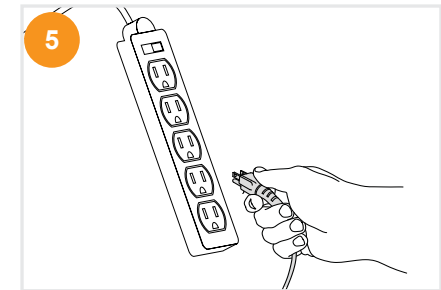

6 Wait 1 minute - LED light will start flashing green once per second.

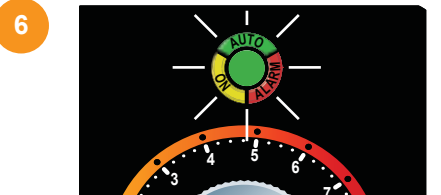

7 **Prime your Stove:**
1) Quickly turn the dial control from OFF to HI
2) Back to OFF
3) Then back to HI

The feed motor will run continuously for two minutes and the LED light will be solid green. Once primed, pellets will drop into the fire pot and the LED light will blink green as ignition starts. This process can take up to 20 minutes.

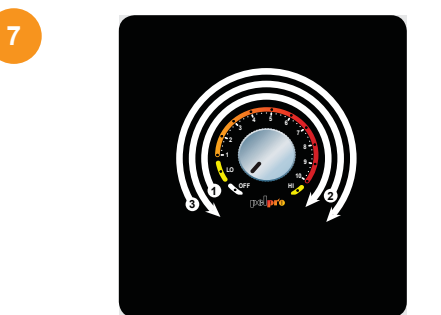

CAUTION:

- During this process DO NOT:
- Try to restart, manually add pellets or use any type of accelerant

Using Your Stove



What Do the Blinking Lights Mean?

Green & Amber - Normal Operation

- Green, Steady On - Feed system is priming
- Green, 1 Blink - Stove is off and ready
- Green, Continuous Blinking - Stove is in the start up/ignition sequence
- Green, Varies Blinks - Varies depending on burn rate
- Amber, Steady On - Stove is set and running at either the minimum or maximum power levels
- Amber, Continuous Blinking - Stove is in the shutdown sequence. *Early models may have a green continuous blinking light during shutdown sequence.

Red - Operational Issue - Refer to troubleshooting

- Red, 1 Blink - Empty hopper, refer to troubleshooting
- Red, 2 Blinks - Exhaust probe alarm, check connections or refer to troubleshooting
- Red, 3 Blinks - Ambient probe alarm, check connections or refer to troubleshooting
- Red, 4 Blinks - Missed ignition, refer to troubleshooting
- Red, 8 Blinks - Exhaust gas over temperature, refer to troubleshooting

If your Stove does not ignite on the initial burn, the LED light will blink red 4 times indicating a missed ignition.

1. Turn your Stove to off, remove and clean the fire pot
2. Confirm fire pot is properly positioned
3. Prime your Stove per previous instructions

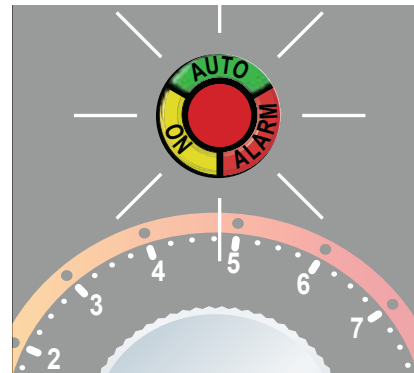

Is this your first start-up after purchase?

If you just bought this Stove, once a fire has been established in your Stove, leave the Stove burning on HI for 30 minutes to allow paint to cure.

After 30 minutes, turn the dial control to OFF and allow your Stove to cool completely. Once cooled, clean the fire pot. Your Stove is now ready to resume normal use.

Using Your Stove

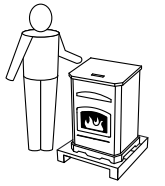

Comfort Settings

Control your comfort with a single dial:

- **OFF setting** - Used to turn your Stove off
- **LO setting** - Your Stove will continue to run on low regardless of room temperature. LED light will be steady amber
- **1 through 10 settings** - Set to your desired comfort level. Once the desired comfort level is achieved the Stove will automatically shut down. When the temperature in the room drops below the desired comfort level, your Stove will automatically restart.
- **HI setting** - Your Stove will continue to run on high regardless of room temperature. LED light will be steady amber.



Pro Tip

If the dial control is turned to the off position and then back on, even if by mistake, your Stove will go through the shutdown process (approximately 15 minutes) and restart.

Trim Adjustment

Trim adjustment is the small dial located below the main dial control. Rotating this dial will adjust the air/fuel ratio and below are examples of when to use it:

- If the fire is too large, lazy or producing black soot, rotate the dial counterclockwise one level at a time and allow 15 minutes for stabilization before making another adjustment
- If your fire is too small and sometimes goes out when there are pellets in the hopper, rotate the dial clockwise one level at a time and allow 15 minutes for stabilization before making another adjustment.

Thermostat

Your PelPro Stove comes with a built-in thermostat system that provides easy temperature adjustments. The Stove is not designed to use a remote control or external thermostat.

Using Your Stove

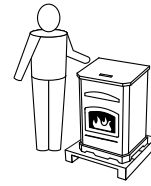

Turning Your Stove Off



1 Turn dial to OFF position



2 LED light will flash amber rapidly *Early models may have a green continuous blinking light during shutdown sequence.



3 Auger stops feeding pellets.

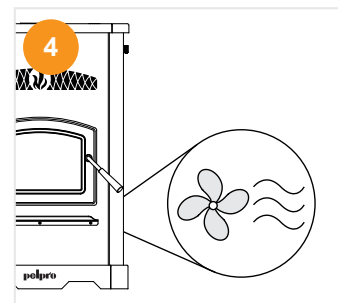

4 Blowers continue to run until after the exhaust temperature has cooled.

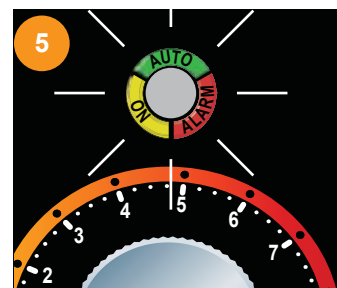

5 LED light will flash once per second.



CAUTION! Smoke Hazard

- Turn dial control to OFF, let Stove completely cool and exhaust blower must be off. Now you can unplug Stove before servicing
- Smoke spillage into room can occur if Stove is not cool before unplugging

Maintaining Your Stove

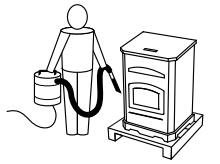

Cleaning & Maintenance

Important:

Regular cleaning helps to assure optimal performance of your Stove. Please refer to page 29 to log your maintenance and cleaning.



Cleaning your Stove
Visit pelprostoves.com or scan this code:

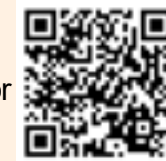

Maintaining your Stove
Visit pelprostoves.com or scan this code:



What You'll Need



Cleaning tool



Phillips head screwdriver



Safety glasses



Gloves



Ceramic glass cleaner & non-abrasive cloth

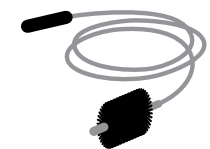

Flue cleaning brush



Metal container with lid



Drop cloth



Ash vacuum

Maintaining Your Stove

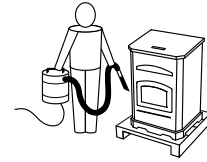

Where, When and How

Disposal of Ashes

Ashes should be placed in a metal container with a tight fitting lid. The closed container of ashes should be placed on a non-combustible floor or on the ground, well away from all combustible materials, pending final disposal. If the ashes are disposed of by burial in soil or otherwise locally dispersed, they should be retained in the closed container until all cinders have been thoroughly cooled.



WARNING!

Disconnect Stove from power supply before servicing

Zone 1 - Firebox

WEEKLY OR AS NEEDED

Fire pot

- Remove the fire pot
- Scrape clean and remove ashes
- Replace fire pot

Firebox

- Remove baffles and vacuum residual ash
- Remove ashes from firebox floor



WARNING!

If using a vacuum to clean Stove, be sure embers are thoroughly cooled to prevent a fire in the vacuum.

Glass

- Apply ceramic glass cleaner
- Use non-abrasive cloth to remove residue

Door Inspection

- The gasket between the glass and firebox should be inspected periodically to make sure there is a good seal.

Maintaining Your Stove

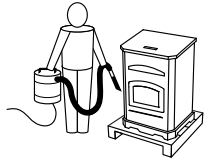

Pro Tip

The type of fuel you are burning will dictate how often you have to clean your fire pot.

If the fuel you are burning has a high dirt or ash content, it may be necessary to clean the fire pot more than once a day.

Poor quality fuel will cause clinkers to form in the fire pot. Clinkers are formed when dirt, ash or a non-burnable substance is heated to 2000 deg. F (1093 deg. C) and becomes glass-like.

Always burn dry fuel. Burning fuel with high moisture content take heat from the fuel and tends to cool the Stove, robbing heat from your home.

Damp pellet fuel can clog the feed system.



CAUTION!

Handle glass assembly with care and refer to maintenance instructions. **When cleaning glass:**

- Avoid striking, scratching or slamming glass.
- Do NOT clean glass when hot
- Do NOT use abrasive cleaners
- Do NOT operate with glass cracked, broken or scratched

Zone 2 - Stove Body

MONTHLY OR AS NEEDED

Convection Blower

- Remove right and left side panel to access and remove convection blower
- Vacuum any debris from the fan blades and blower housing

Hopper

- Empty hopper of any pellets
- Vacuum any remaining pellets/debris from the hopper

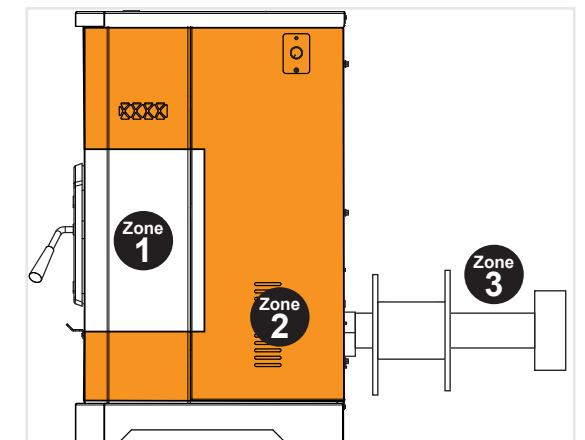

Maintaining Your Stove

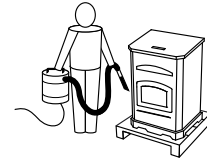

Electrical Components

- Identify and remove any debris
- Verify all connections are secure

ANNUALLY OR AS NEEDED

Exhaust Blower

- Remove left side panel to access and remove exhaust blower
- Vacuum any debris from the fan blades and blower housing

Zone 3 - Venting

ANNUALLY OR AS NEEDED

Termination Cap

- Remove termination cap
- Brush out to remove dust and hard buildup

Vent Components

- Soot, creosote, and fly ash will collect in the exhaust venting system and restrict the flow of the flue gases. This build up will occur more quickly in horizontal sections and elbows.
- Use the appropriate sized chimney brush to remove ash and buildup from the venting

Outside Air Kit

- Ensure there are no obstructions in the outside air kit cap

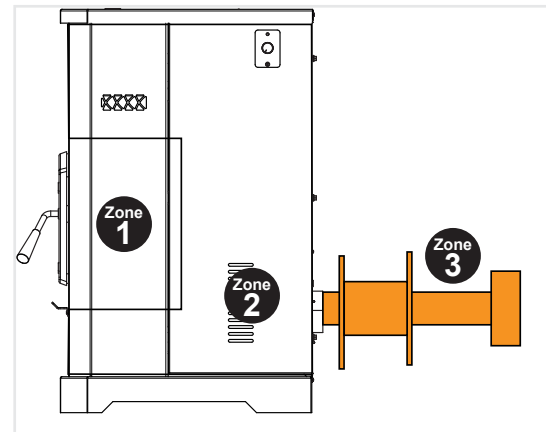

Having Trouble?

Visit the Troubleshooting section of this manual.

Caution!

When wood pellets are burned at a low temperature, they produce organic vapors which combine with moisture to form creosote vapors.

Creosote vapors condense in the relatively cool chimney flue of a newly-started or a low-temperature fire. As a result, creosote residue accumulates on the flue lining. When more heat is called for, this residue can be ignited, which creates an extremely hot fire in the chimney flue; this may damage the chimney or even destroy your home.

Your chimney should be inspected once every few months during the heating season to determine if a creosote or soot buildup has occurred. If creosote or soot has accumulated, it should be removed to reduce the risk of a chimney fire.

Replacement Parts

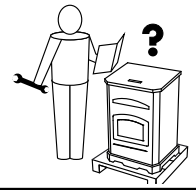

Replacement part for your Stove

Visit pelprostoves.com

Zone 1 - Front of Stove

Glass

1. Open the door from the appliance by lifting door off of hinge pins and lay on a flat surface face down.
2. Using a Phillips head screwdriver, remove the 3 brackets and set aside.
3. Remove old glass and gasket from door.
4. Replace gasket to door and add glass.
5. Re-install the brackets using the same screws.

Glass replacement kit: SRV7081-173
Door assembly replacement kit: SRV7086-021

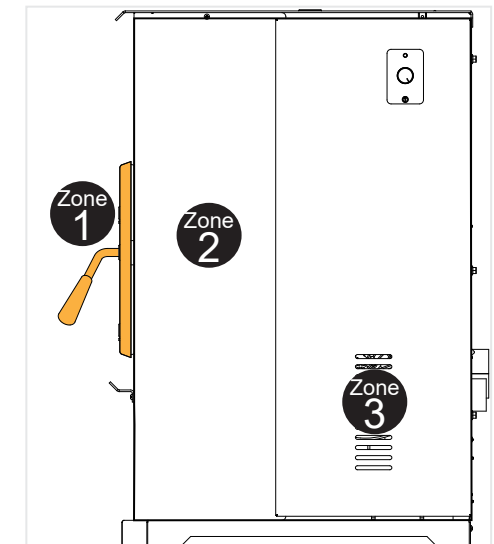

WARNING!

Glass is 5mm thick high temperature heat resistant ceramic glass.

- DO NOT REPLACE with any other material
- Alternate material may shatter and cause injury

Zone 2 - Firebox

Baffles

1. Turn the dial control to the off position. Make sure the unit is cool.
2. Remove the center baffle first by using the handle at the top of the baffle and pull up and then towards you. The hooks on the baffle will slide out of the slots in the bracket.
3. Remove the left baffle and then the right baffle by pulling up and then towards you. The left and right baffles have similar hooks and slots.

Replacement kit: SRV7077-006

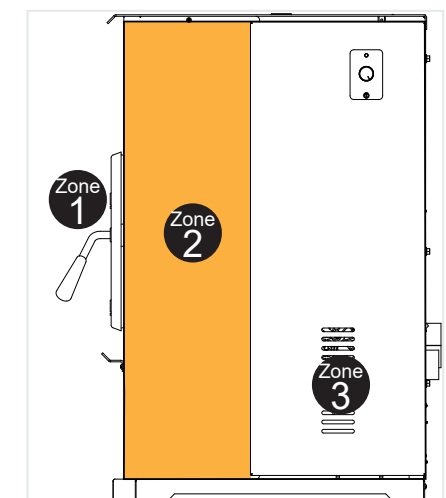

Replacement Parts

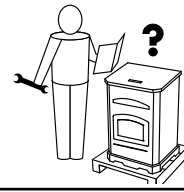

Zone 3 - Back of Stove

Convection Blower

1. Turn the dial control to the off position. Unplug the power to the unit.
2. Remove the right side panel by loosening the three screws attaching it to the back of the appliance.
3. Using a 7/16 wrench or socket, remove the 2 nuts holding the blower to the convection plenum
4. Lower the back of the blower and lift out.
5. With the blower removed, unplug its wires from the wire harness.
6. Remove the screws holding the retainer plate to the convection blower housing.
7. To replace, put the bottom lip of the blower into the lower slot. Attach the top of the blower to nuts. Reattach the metal plate and screw nuts into bolts.
8. Attach wires to wire harness.
9. Attach the right side panel and tighten screws.

Replacement kit: **KS-5020-1052**

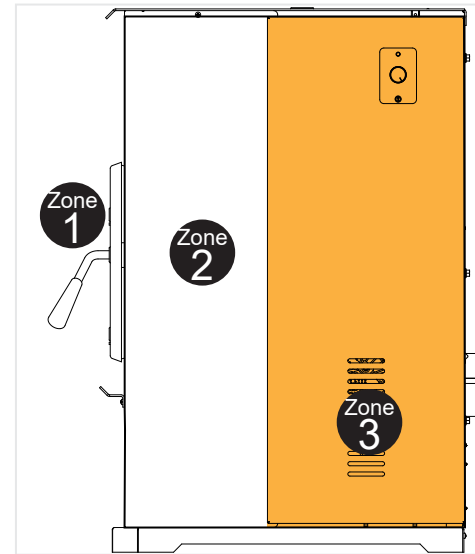

Exhaust Blower

1. Turn the dial control to the off position. Unplug the power to the unit.
2. Remove the left side panel by loosening the three screws attaching it to the back of the appliance.
3. Disconnect 2 white wires from the blue wires of the exhaust blower.
4. Remove the blower motor attached to a removable plate on the exhaust blower. Depending on the model, use a 1/4 inch socket, or 1/4 inch Nut Driver or #2 Phillips Head screw driver to loosen the 6 screws in the keyhole shaped holes and rotate the plate. It is only necessary to loosen screws.
5. Remove the exhaust blower and gasket.
6. Check for degradation on the gasket and replace if necessary using the gasket included in the kit.
7. Re-install in reverse order.

Replacement kit: **812-4400**

Replacement Parts

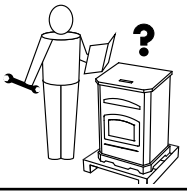

Snap Disc

1. Turn the dial control to the off position. Unplug the power to the unit.
2. Using #2 Phillips screwdriver, loosen the bolts on the rear of the unit holding on the left side panel. You do not need to remove the screws. Remove side panel by lifting up and out.
3. Locate the snap disk on the top side of the feed tube where it meets the hopper. Disconnect the wire leads from the snap disk.
4. Using a #1 Phillips screwdriver, remove two 6-32 fasteners retaining the snap disk onto the side of the feed tube.
5. Using the same fasteners, attach the new snap disk. Attach the wire leads.
6. Restore power.

Replacement kit: **SRV230-0080**

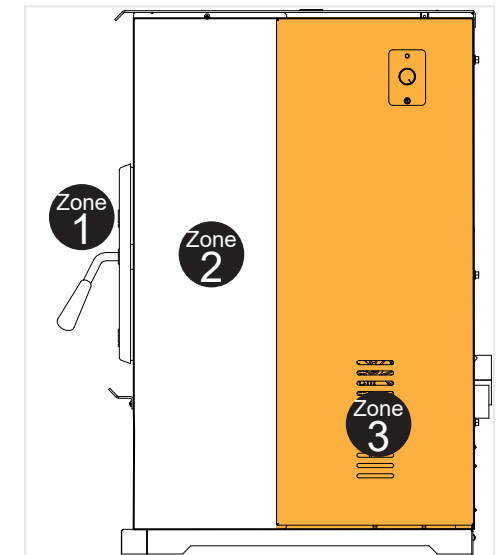

Igniter

1. Turn the dial control to the off position. Unplug the power to the unit.
2. Remove the right side panel & unplug the wire leads to the igniter.
3. Remove the screw in the top of the igniter chamber. Pinch the ends of the bracket together and pull the igniter straight out of the igniter chamber.
4. If there is difficulty in removing the igniter from the chamber, the chamber can be removed from the rear of the firebox by removing the 1/4-20 bolt using 3/8" socket.
5. Re-install the new igniter into the chamber using the bracket. Reattach wires to terminals.
6. Inspect the igniter from the front of the unit by removing the firepot and looking into the end of the chamber. **MAKE SURE THE IGNITER IS CENTERED IN THE CHAMBER.**

Replacement kit: **SRV7000-660**

Replacement Parts

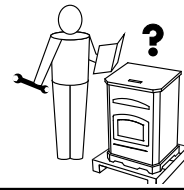

Control Board

1. Turn the dial control to the off position. Unplug the power to the unit.
2. Unplug the wires from the control board. The connectors are locking connectors. Pinch the release tab on each connector and gently tug and rock loose.
3. Pinch the 4 plastic pins from the rear of the unit with needle nose pliers to release the control board connectors.
4. Install new board following the steps in reverse.

Replacement kit: SRV7104-050

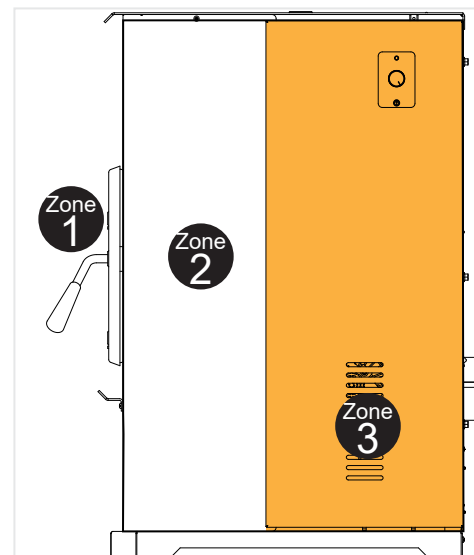

Feed Motor Assembly

1. Turn the dial control to the off position and unplug the appliance. Remove the right side panel and feed motor cover plate in the rear of the appliance.
2. Remove the 4 screws and cover plate.
3. Remove remaining pellets in feed assembly.
4. Unplug feed motor from wire harness.
5. Remove silicone from around busing end cap. Using Phillips head screwdriver remove 2 screws retaining the end cap to the feed tube.
6. From inside the hopper, lightly tap on the end cap alternating side to side to remove feed assembly from feed tube.
7. Re-install new feed assembly in reverse order; ensuring that the top of the feed bushing is in place and the busing end cap is symmetrical in the feed tube chamber prior to final tightening of the retaining screws. Silicone the end cap to the feed tube.
8. Plug the feed motor leads back in and restore power.

Replacement kit: SRV7077-014

Troubleshooting



Troubleshooting your Stove
Visit pelprostoves.com or scan the code:



Power Related



In the event of a power outage:

- If using a generator, PelPro recommends a steady state generator for best Stove performance.
- This Stove needs 110v to run properly. This Stove has not been tested for use with a third party battery backup.

Pro Tip

Check passages to assure they are clear of ash and obstructions. Poor airflow leads to poor performance of your Stove.



Stove plugged in but no response

- Unplug your Stove
- Check your home's circuit breaker
- Reset snap disc (located between drop tube and hopper (Zone 2))
- Visually inspect wires, blowers and power cord for breaks or wear to find cause of possible short circuit (Zone 2)

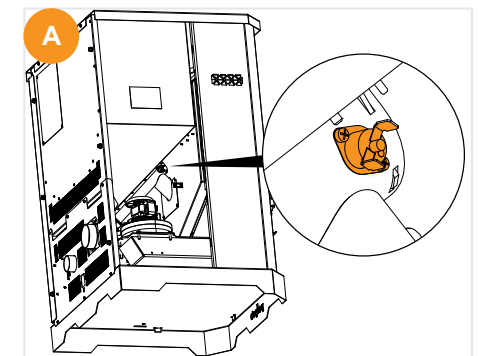

Component (i.e. blower) fails to start or fails to turn off

- Unplug your Stove
- Check all connections and power plugs are secure
- Visually inspect wires, blowers and power cord to find cause of possible short circuit

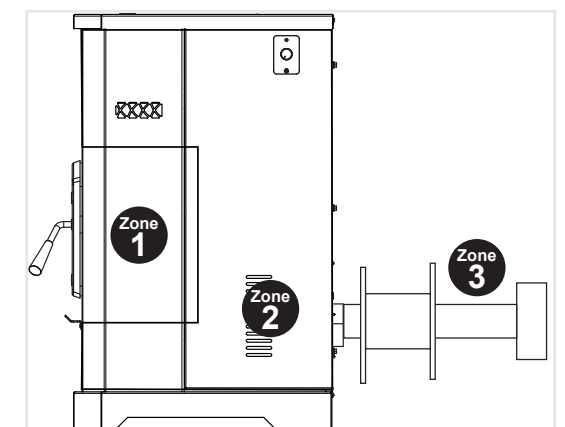

Troubleshooting



Blockage Related

Black soot on outside of house

- Confirm exhaust path is clean and clear (Zone 1 and 3)
 - Adjust air/fuel ratio using trim adjustment dial (See page 19 for trim adjustment instructions)
- Ensure termination cap has at least 18" clearance to reduce the effects of soot blow-back on home exterior (ie. siding)—if not able, refer to page 8 for alternate installation options

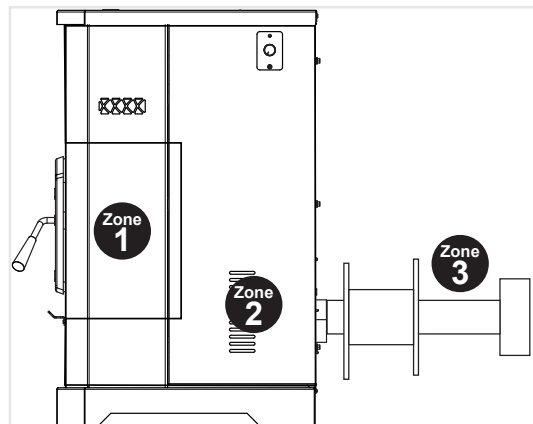

Rumbling/whistling noise during operation

- Confirm exhaust path is clean and clear (Zone 1 & 3)
 - Adjust air/fuel ratio using trim adjustment dial (See page 19 for trim adjustment instructions)

Stove will not light

- Confirm firebox is clean and clear (Zone 1)
 - Igniter is getting hot (glows orange)
- Inspect Stove body (Zone 2)
 - Confirm fuel is in hopper, close lid securely
 - Remove right side panel to access and confirm vacuum switch is clear and connected at both ends
 - Confirm all exhaust blower connections are secure
 - Confirm the feed assembly and motor are clean and clear of debris
- Confirm exhaust path is clean and clear (Zone 3)

Troubleshooting



Blockage Related

Fire starts but goes out

- Confirm firebox is clean and clear (Zone 1)
 - Ensure fire pot holes are clear
- Inspect Stove body (Zone 2)
 - Confirm exhaust probe is connected
 - Inspect and clean the exhaust outlet
- Confirm exhaust path is clean and clear (Zone 3)

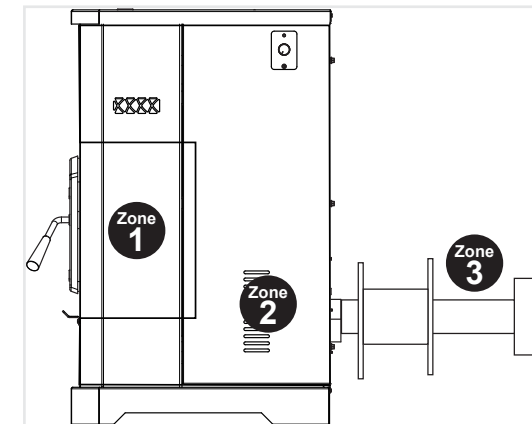

Starts and stops frequently in automatic mode

- Determine if your room is experiencing varying temperatures due to repeated opening/closing of doors or windows—correct if necessary
- Examine Stove body (Zone 2)
 - Inspect ambient probe and confirm that at least 2" is exposed outside of Stove body

Slow or smoky start-up and/or lazy flame

- Confirm exhaust path is clean and clear (Zone 3)
- Examine Stove body (Zone 2)
 - Align igniter so it is properly placed and centered
 - Review fuel quality (see Pellet Fuel information on page 14)

Troubleshooting



Symptom	Possible Cause	Corrective Action
Igniter does not turn off	Igniter short circuit. The fuse will be blown and upon replacement of the fuse, the igniter will remain on when Stove has power.	Inspect wires, blowers, and power cord to find cause of short circuit. Replace board and failed component.
Feed motor does not shut off	Feed motor short circuit. The fuse will be blown and upon replacement of the fuse, the feed motor will remain on when Stove has power.	Open hopper to stop the feed motor. Inspect wires feed motor, control board, and power cord to find source of short circuit. Replace control board and failed component.
Stove fails to shut off.	Stove running in maximum or minimum off.	Turn dial control to Off position. See Also, "Feed Motor Does Not Shut Off". The Stove should go into a shutdown.
Large, lazy flame, orange color. Black ash on glass.	Dirty Stove. Poor fuel quality, high ash content. Incorrect air-fuel adjustment Excessive feeding/Feed Motor locked on	Clean Stove, including fire pot and venting system. Clean exhaust path. Try a different brand of pellets. Turn fuel adjustment trim dial to COUNTER-CLOCKWISE to increase combustion air speed; see trim pot adjustment section. Follow corrective action for feed motor does not turn off symptom.
Excessive fuel spilling over the fire pot into the ash wells and/or excessive flame	Excessive feeding/Feed Motor locked on	Follow corrective action for feed motor does not turn off.

Troubleshooting



Following correction of any alarm, turn the dial control to the OFF position, wait 10 seconds and turn back to desired setting OR unplug the Stove, wait 10 seconds then restore power.

Alarm (LED Flashing RED)	Possible Cause	Corrective Action
1 Flash: Empty Hopper	No fuel is delivered to the fire pot to sustain flame Hopper empty (most likely) Auger Jam (next likely) No vacuum Hopper lid open	Fill the hopper, inspect the feed tube for jams, inspect the venting and firebox for obstructions and clean if necessary, inspect the exhaust blower to make sure it runs, or close the hopper lid.
2 Flashes: Exhaust Probe Fail <i>The exhaust probe senses a temperature of less than negative 20 degrees Celsius or above 300 degrees Celsius.</i>	Flame is evident but the exhaust probe is not able to recognize the hot exhaust temperature Exhaust probe not attached to outlet Exhaust path is dirty	Inspect and clean the exhaust outlet, firebox, fire pot, and behind the baffles. Inspect the exhaust probe to see if it is securely attached to the side of the exhaust outlet.
3 Flashes: Ambient Probe Alarm <i>The ambient probe senses a temperature of less than negative 20 degrees Celsius or above 70 degrees Celsius.</i>	The exhaust temperature is above or below the acceptable range. Exhaust Probe Failure Not plugged in Failed component	Plug the probe into the board Replace the component
4 Flashes: Missed Ignition <i>During the ignition sequence the load does not ignite. The Stove will automatically retry once from the first failed attempt.</i>	The ambient temperature is above or below the acceptable range. Ambient Probe Failure Not plugged in Failed component	Plug the probe into the board Replace the component
4 Flashes: Missed Ignition <i>During the ignition sequence the load does not ignite. The Stove will automatically retry once from the first failed attempt.</i>	Fuel No fuel Hopper Empty Feed Jam Feed doesn't turn Feed motor disconnected or failed Fire pot Fire pot Dirty so fuel is not near ignition hole in the fire pot Igniter No power Debris in the end of the igniter chamber	Fill the hopper Inspect and clear jam in the feed tube Inspect the feed motor circuit (hopper lid must be closed, vacuum switch must be closed (ie exhaust blower on), and feed motor must be plugged in. Clean the fire pot Check leads and if the igniter works. Clean the end of the igniter chamber from inside the firebox (removal of the fire pot required for this step).
8 Flashes: Exhaust Over Temperature <i>The exhaust temperature has exceeded the allowable temperature.</i>	Fuel Feed Motor Locked On Non-approved fuel used Convection blower Dirty Failed Installation Installation configuration is tight allowing for limited air circulation around the Stove.	Review the feed motor and feed rates. Normal feed motor operation is on between 1* and 4* seconds out of every 7 seconds. (*depending on model and burn rate setting) If the feed motor does not turn off, replace the control board. Review the fuel being used. Clean Replace Review the installation and move if necessary.

Troubleshooting



? Still having trouble?

Access additional resources at:
pelprostoves.com/troubleshooting



Warranty

 If replacement parts are needed, please note warranty coverage begins on the date of purchase. Retain your original receipt as proof of purchase. The warranty period for covered components is as follows:

Components Covered	Warranty Period (Parts only, Labor not included)
Electrical	1 Year
Steel Parts (excluding fire pot)	5 Years
All replacement parts are covered for remainder of original warranty period or 90 days, whichever is longer	90 Days

Additional terms and limitations apply. See page 38 for complete warranty information.

Support



Please review the “Maintaining Your Stove” and “Troubleshooting” sections in this manual.



Visit pelprostoves.com to access:

- Order replacement parts
- Installation videos
- Troubleshooting videos
- Use and care videos
- Manuals and more

Listings and Certifications

Stove Certification

Series	PP150
Laboratory	UL LLC
Safety Report No.	MH60687
Type	Solid Fuel Room Stove/Pellet Fuel Burning Type
Standard	ASTM E1509-12 and ULC S627-00, Room Stove Pellet Fuel Burning type and (UM) 84-HUD, Mobile Home Approved.

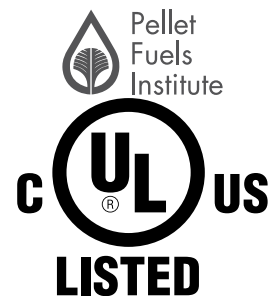

Note

This installation must conform with local codes. In the absence of local codes you must comply with **ASTM E1509-12 and ULC S627-00 and (UM) 84-HUD**

⚠ WARNING!

- It is critical to have a working smoke detector installed in the home of Stove operation.
- Smoke alarms that are properly installed and maintained play a vital role in reducing fire deaths and injuries. Having a working smoke alarm reduces the chance of fire related injuries.
- Install at least one carbon monoxide detector on each floor of your home.



⚠ WARNING! Asphyxiation Risk.
DO NOT INSTALL IN A SLEEPING ROOM. Your Stove consumes oxygen in the room.

Note

This wood stove needs periodic inspection and repair for proper operation. It is against federal regulations to operate this wood heater in a manner inconsistent with operating instructions in this manual.

Mobile Home Approved

This Stove is approved for mobile home installations **when not installed in a sleeping room and when an outside combustion air inlet is provided.**

- The structural integrity of the mobile home floor, ceiling, and walls must be maintained
- The Stove must be properly grounded to the frame of the mobile home with #8 copper ground wire, and use only listed double-wall connector pipe
- Outside Air Kit provided with each Stove must be installed in a mobile home installation and must remain clear of leaves, debris, ice and/or snow. It must be unrestricted while the Stove is in use to prevent room air starvation which causes smoke spillage.
- The Stove must be secured to the mobile home structure by bolting it to the floor through holes provided at bottom of your cast legs on your Stove.

Listings and Certifications

Glass Specifications

This Stove is equipped with 5mm ceramic glass. Replace glass only with 5mm ceramic glass. Please contact PelPro for replacement glass.

Electrical Rating (On High)

PP150: 120 VAC, 60 Hz, Start 2.6 Amps, Run 2.3 Amps

BTU & Efficiency Specifications

Emissions Report No.	0135PS041E
EPA Certificatin #	Number: 128-18
EPA Certified	0.53 grams per hour
*LHV Tested Efficiency	87.5%
**HHV Tested Efficiency	81.9%
***BTU Output	9,605 to 40,667 / hr.
****BTU Input	11,676 to 49,207 / hr.
*****Heating Capacity	1,225 to 2,500 sq. ft. depending on climate zone
Vent Size	3" or 4" L or PL
Hopper Capacity	150 lbs (Approximate)
Fuel	Premium Wood pellets
Shipping Weight	275 lbs



The PP150 is Certified to comply with 2020 particulate emission standards.

- *Weighted average LHV efficiency using data collected during EPA emissions test.
- **Weighted average HHV efficiency using data collected during EPA emissions test.
- ***Maximum BTU output based on HHV efficiency and the high burn section of the EPA emissions test.
- ****Maximum BTU input based on the high burn section of the EPA emissions test.
- *****Heating capacity depends on climate zone, structure layout, insulation, windows, etc.

Stove Dimensions

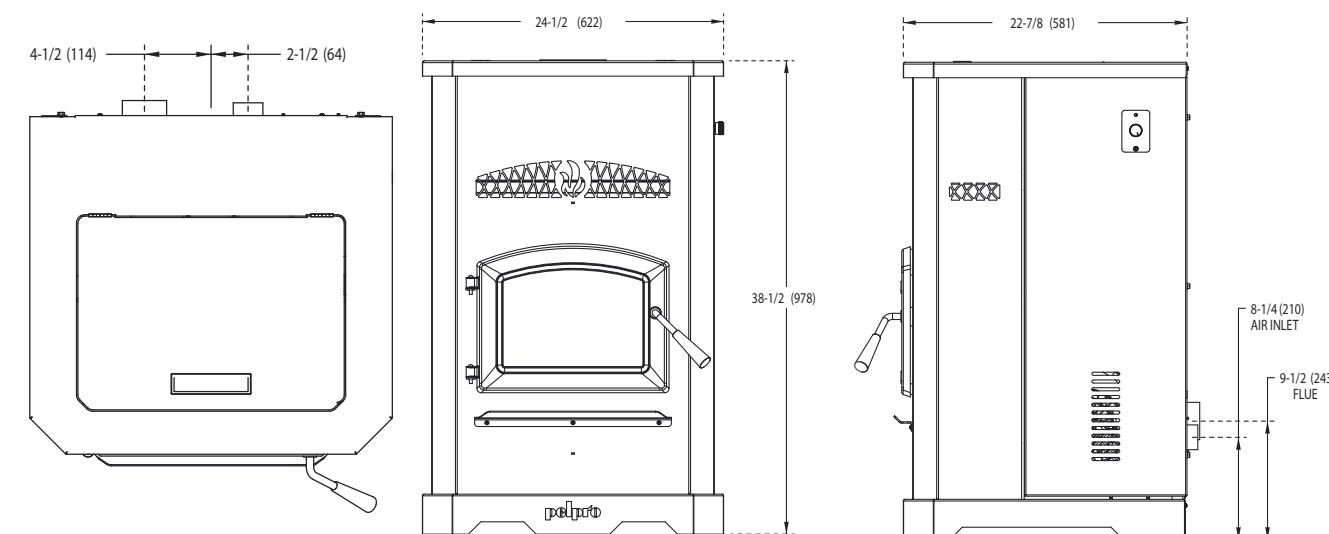

Listing and Code Approvals

Listing and Code Approvals

Listings and Certifications

Reference Materials

Hearth & Home Technologies, Inc. - PelPro Limited Warranty

Hearth & Home Technologies, Inc. (HHT), on behalf of its PelPro brand, extends the following warranty for PelPro Stoves purchased from an authorized retailer.

If you experience issues with your PelPro Stove, Consumer Care is available to assist you with troubleshooting technical issues.

This warranty covers components of the PelPro Stoves as listed in the table below.

Warranty Coverage:

Subject to the table below, HHT warrants to the owner of the PelPro Stove that the Stove will be free from defects in materials and workmanship at the time of manufacture. After installation, if covered components are found to be defective in materials or workmanship during the applicable warranty period, HHT will replace the covered components.

HHT, at its own discretion, may fully discharge all of its obligations under such warranties by replacing the product itself or refunding the verified purchase price of the product itself. The maximum amount recoverable under this warranty is limited to the purchase price of the product. This warranty is subject to conditions, exclusions, and limitations as described below.

Warranty Period:

Warranty coverage begins on the date of original purchase. The warranty period for covered components is as follows:

Components Covered	Warranty Period (Parts only, Labor not included)
Electrical	1 Year
Steel Parts (excluding fire pot)	5 Years
All replacement parts are covered for remainder of original warranty period or 90 days, whichever is longer	90 Days

Parts Service & Returns:

HHT is proud to offer the best technical and sales support in the industry. If you have any questions about how to operate your Stove or if you need service parts, please visit PelProstoves.com.

Warranty Exclusions:

Warranty does not cover damage or breakage due to misuse, improper handling or modifications. There is no warranty on the paint, glass, fire pot, fire brick, or any gaskets, or against damage caused from corrosion. There is no expressed or implied performance warranty on PelPro units as HHT has no control over the installation, operation, cleaning, maintenance, or type of fuel burned.

Some states do not allow exclusion or limitation of incidental or consequential damages, or limitations of implied warranties, so the limitations or exclusions set forth in this limited warranty may not apply to you. This limited warranty gives you specific legal rights and you may have other rights, which vary from state to state. Warranty is void if the PelPro Stove has not been installed, operated, cleaned and maintained in strict accordance with HHT's instructions.

NEITHER HHT NOR THE RETAILER FROM WHO YOU PURCHASED YOUR PELPRO UNIT SHALL BE RESPONSIBLE, LEGALLY OR OTHERWISE, FOR THE INCIDENTAL OR CONSEQUENTIAL DAMAGE TO PROPERTY OR PERSONS RESULTING FROM THE USE OF THIS PRODUCT. ANY WARRANTY IMPLIED BY LAW, INCLUDING BUT NOT LIMITED TO IMPLIED WARRANTIES OF THE MERCHANTABILITY OR FITNESS, SHALL BE LIMITED TO ONE (1) YEAR ON THE BREACH OF THIS WARRANTY OR ANY TYPE OF WARRANTY EXPRESSED OR IMPLIED BY LAW. HHT SHALL IN NO EVENT BE LIABLE FOR ANY SPECIAL, INDIRECT, CONSEQUENTIAL OR OTHER DAMAGES OF ANY NATURE WHATSOEVER IN EXCESS OF THE ORIGINAL PURCHASE PRICE OF THIS PRODUCT. ALL WARRANTIES BY HHT ARE SET FORTH HEREIN AND NO CLAIM SHALL BE MADE AGAINST HHT ON ANY ORAL WARRANTY OR REPRESENTATION.

Wiring Schematic for Control Board

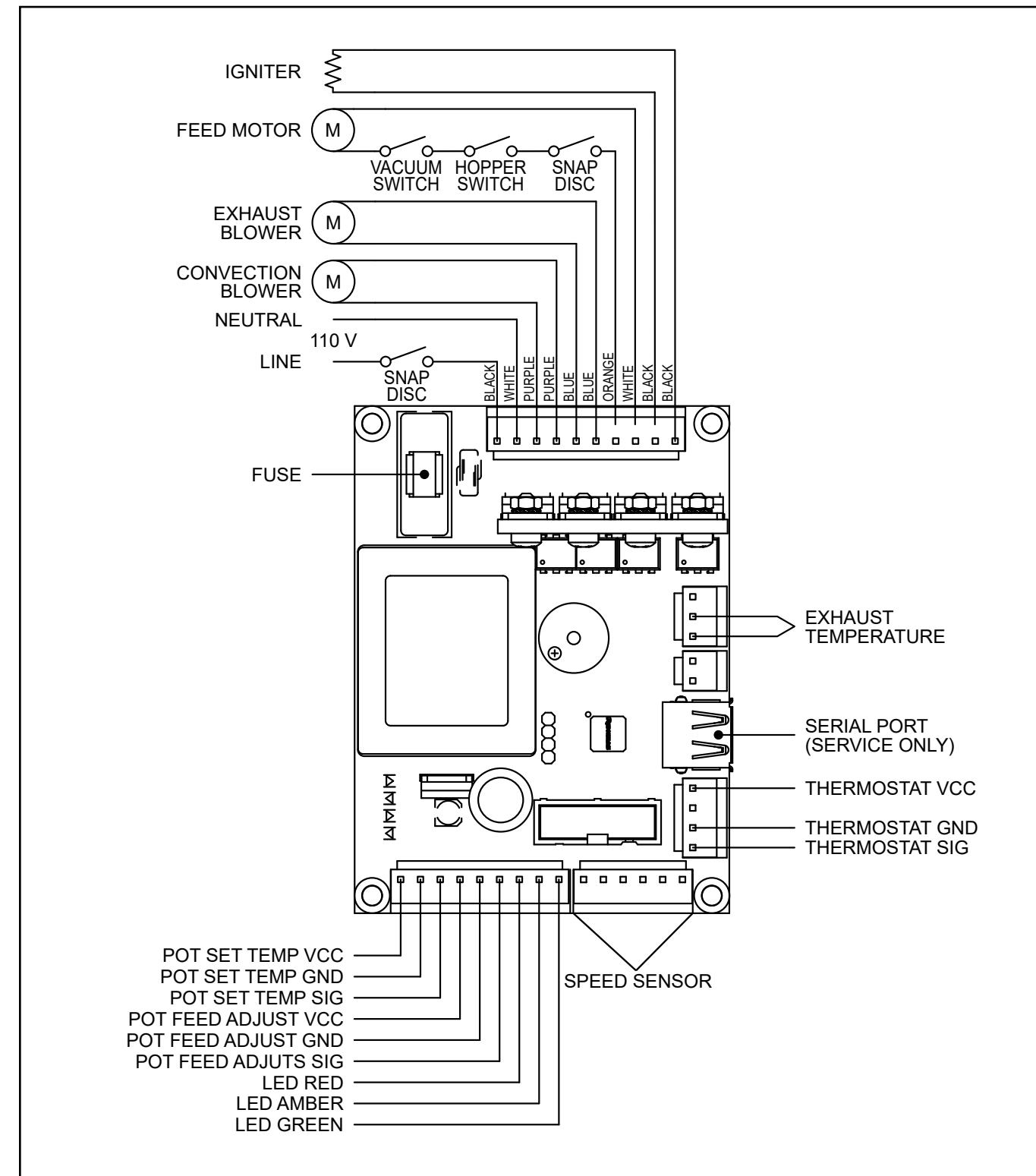

Reference Materials



Service Parts

PP150

Pellet Stove

Beginning Manufacturing Date: Aug 2021
Ending Manufacturing Date: Active

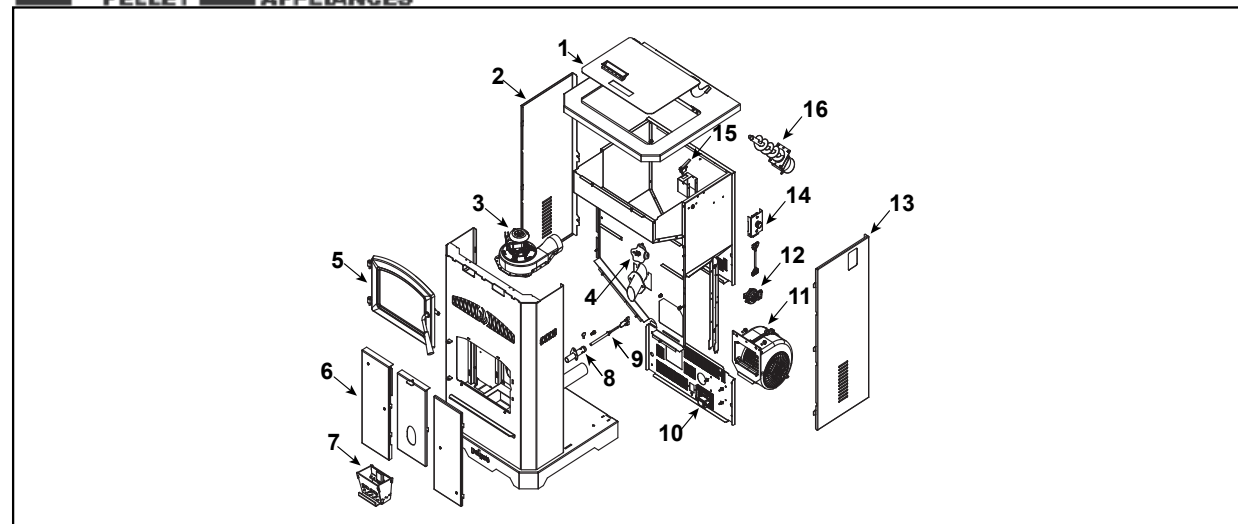

IMPORTANT: THIS IS DATED INFORMATION. When requesting service or replacement parts for your appliance please provide model number and serial number. All parts listed in this manual must be ordered from a dealer.



Stocked at Depot

ITEM	DESCRIPTION	COMMENTS	PART NUMBER	Stocked at Depot
1	Hopper Lid Assembly		SRV7086-019	
	Hopper Extension		PPHE200	
	Handle, Hopper Lid		SRV200-0110	
2	Side Curtain, Left Hand		SRV8104-154	Y
3	Exhaust Combustion Blower		812-4400	Y
	Gasket, Between Blower Housing and Stove		SRV240-0812	Y
	Gasket, Between Blower Housing and Motor		812-4710	Y
4	Snap disc, Manual Reset		SRV230-0080	Y
5	Door Assembly		SRV7086-021	Y
6	Baffle Kit		SRV7077-006	
7	Firepot		SRV7077-003	Y
8	Igniter Chamber Kit		SRV7077-110	
9	Igniter Kit		SRV7000-660	Y
10	Control Board		SRV7104-050	Y
11	Convection Blower		KS-5020-1052	Y
	Convection Blower Gasket		SRV7081-195	
	Convection Blower Bracket		SRV7081-210	
12	Vacuum Switch		SRV7000-531	Y
	Vacuum Hose, 5/32 ID	3 Ft	SRV240-0450	Y
	Hose, Barb Assembly		SRV229-0920	
13	Side Curtain, Right Hand		SRV8104-153	Y
14	Dial Control		SRV7083-036	Y
	Wire Harness, Dial Control		SRV7000-667	Y
15	Hopper Switch		SRV7000-612	Y

See Following page for additional service parts

6/21

Reference Materials



Service Parts

PP150

Beginning Manufacturing Date: Aug 2021
Ending Manufacturing Date: Active

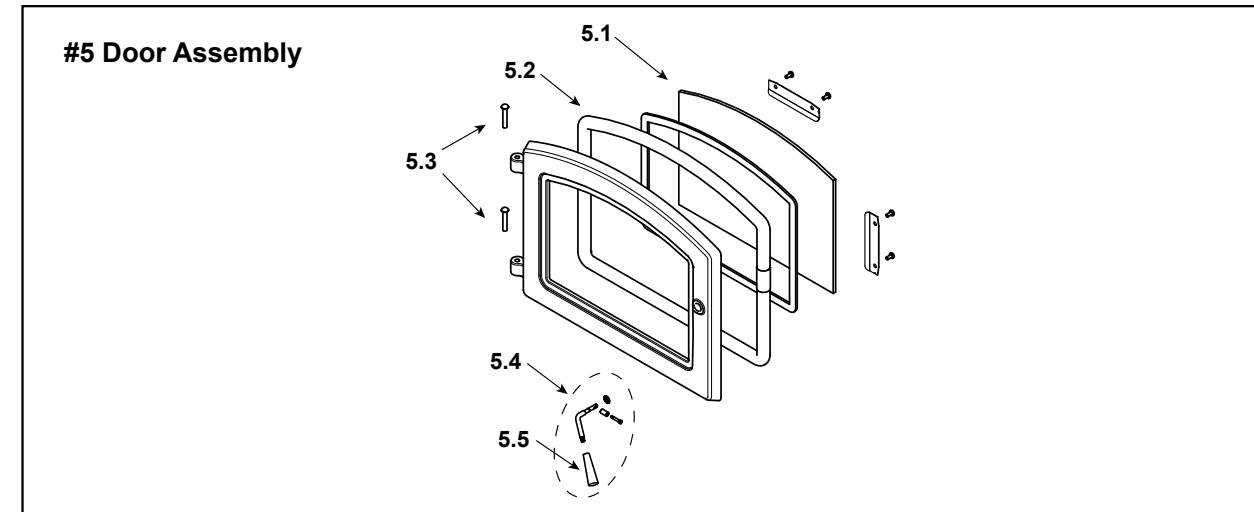

IMPORTANT: THIS IS DATED INFORMATION. When requesting service or replacement parts for your appliance please provide model number and serial number. All parts listed in this manual must be ordered from a dealer.



Stocked at Depot

ITEM	DESCRIPTION	COMMENTS	PART NUMBER	Stocked at Depot
5	Door Assembly		SRV7086-021	Y
5.1	Glass Assembly		SRV7081-173	
5.2	Rope, Door, 3/4" x 84"		832-1680	
5.3	Hinge Pins	Pkg of 2	433-1590/2	
5.4	Threaded Handle Assembly Kit		SRV7093-024D	Y
5.5	Handle Black Phenolic Kit		KS-5140-1442	Y

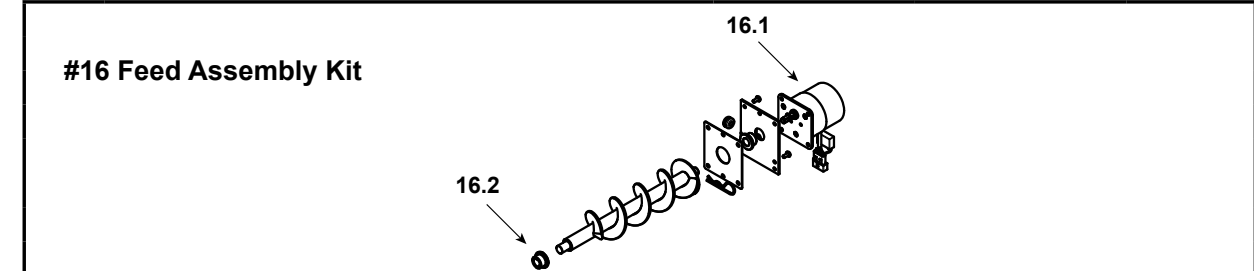

ITEM	DESCRIPTION	COMMENTS	PART NUMBER	Stocked at Depot
16	Feed Assembly Kit		SRV7077-014	Y
16.1	Feed Motor		SRV7000-670	Y
16.2	Feed Shaft Bushing	Pkg of 2	7000-600/2	Y
	Power Cord		812-1180	Y
	Ambient Probe		SRV7000-668	Y
	Component Pack		SRV8104-028	
	Exhaust Probe		SRV7000-669	Y
	Wire Harness		SRV7093-184	Y
	Wire Clip	Pkg of 10	7000-400/10	Y

Reference Materials

Reference Materials

Reference Materials



We recommend that you record the following information for your heating stove:

Date Purchased / installed: _____
(Attach Proof of Purchase)

Serial Number: _____ Location on Stove: _____

Store Purchased From: _____

Store Location: _____

Maintenance Log:

Reference Materials



Maintenance Log:

