

Models:

- MTCH-18NG-B
- MTCH-24NG-B
- MTCH-30NG-B
- MTCH-ST-18NG-B
- MTCH-ST-24NG-B

Real Wood Elite Gas Hearth Kits



Installation and service of this appliance should be performed by qualified personnel. Hearth & Home Technologies suggests NFI certified or factory-trained professionals, or technicians supervised by an NFI certified professional.

Check with your local building code agency before you begin installation to ensure compliance with local codes, including the need for permits and follow-up inspections. If you encounter any problems regarding code approvals, or if you need clarification of any of the instructions contained here, contact the Technical Services Dept., Hearth & Home Technologies Inc., 20802 Kensington Blvd., Lakeville, MN 55044, phone 1-888-427-3973 or 1-800-927-6841.

CAUTION

DO NOT DISCARD THIS MANUAL

- Important operating and maintenance instructions included.
- Read, understand and follow these instructions for safe installation and operation.
- Leave this manual with party responsible for use and operation.

⚠ WARNING

If the information in these instructions is not followed exactly, a fire may result causing property damage, personal injury, or death.

- Do not store or use gasoline or other flammable vapors and liquids in the vicinity of this or any other appliance.
- **What to do if you smell gas:**
 - Do not try to light any appliance.
 - Do not touch any electrical switch. Do not use any phone in your building.
 - Immediately call your gas supplier from a neighbor's phone. Follow the gas supplier's instructions.
 - If you cannot reach your gas supplier, call the fire department.
- Installation and service must be performed by a qualified installer, service agency, or the gas supplier.

⚠ WARNING

HOT! DO NOT TOUCH. SEVERE BURNS MAY RESULT. CLOTHING IGNITION MAY RESULT.

Glass and other surfaces are hot during operation and cool down.

- Keep children away.
- CAREFULLY SUPERVISE children in same room as appliance.
- Alert children and adults to hazards of high temperatures.
- Keep clothing, furniture, draperies and other combustibles away.

In the Commonwealth of Massachusetts:

- This appliance must be installed by a licensed plumber or gas fitter.
- The chimney flue damper, when used with gas logs, will be welded open or completely removed.
- A CO detector shall be installed in the room where the appliance is installed.

Note: An arrow (➡) found in the text signifies change in content.

**Read this manual before installing or operating this appliance.
Please retain this owner's manual for future reference.**

Congratulations

Congratulations on selecting a Hearth & Home Technologies gas log set—an elegant and clean alternative to burning wood. The Hearth & Home Technologies gas log set you have selected is designed to provide the utmost in safety, reliability, and efficiency.

As the owner of this new gas log set, you'll want to read and carefully follow all of the instructions contained in this owner's manual. Pay special attention to all cautions and warnings.

This owner's manual should be retained for future reference. We suggest you keep it with your other important documents and product manuals.

The information contained in this owner's manual, unless noted otherwise, applies to all models and gas control systems.

Your new gas log set will give you years of durable use and trouble-free enjoyment. Welcome to the Hearth & Home Technologies family of appliance products!

Homeowner Reference Information	<i>We recommend that you record the following pertinent information about your gas log set:</i>
Model Name: _____	Date purchased/installed: _____
Serial Number: _____	Location on appliance: _____
Dealership purchased from: _____	Dealer phone: _____
Notes: _____	

Listing Label Information/Location

The model information regarding your specific gas log set can be found on the rating plate.

Gas Type →

Serial # →

Model # →

Hearth & Home Technologies Inc. 1915 W. Saunders Street Mt. Pleasant, IA 52641		SERIAL NO. DE SÉRIE		GA000001	GAS-FIRED LISTED Decorative Gas Burning Appliance for Installation in Vented Fireplace 13RN
ANSI Z21.60-2003 CGA 2.26-2003 DECORATIVE GAS APPLIANCE FOR INSTALLATION IN SOLID FUEL BURNING FIREPLACES		MFG. DATE DATE DE FAB.			
MODEL MODÈLE MTCH-18NG-B		ALTITUDE 0-2000 FT/PI		2000-4500 FT/PI	
MAX. INPUT/DÉBIT		xxxxx (xx) BTUH (kWh)		xxxxx (xx) BTUH (kWh)	
MANIFOLD PRESSURE		PRESSION TUBULAIRE		xx (xx) IN. W.C.(C. D'EAU NAT KPa)	xx (xx) IN. W.C.(C. D'EAU NAT KPa)
MAX INLET PRESSURE		MIN. INLET PRESSURE		xx (xx) IN. W.C.(C. D'EAU NAT KPa)	xx (xx) IN. W.C.(C. D'EAU NAT KPa)
FOR THE PURPOSE OF INPUT ADJUSTMENT		PRESS. MIN. D'ALIMENTATION			
ORIFICE SIZE		Diam. de l'injecteur		xx/xx (xx) DIA. IN. (mm)	xx/xx (xx) DIA. IN. (mm)
MIN. FIREPLACE OPENING SIZE		FRONT REAR		WIDTH WIDTH	DEPTH HEIGHT
		xx in. xx in.		xx in. xx in.	xx sq. in. xx sq. in.
		(xx mm) (xx mm)		(xx mm) (xx mm)	(xx mm) (xx mm)

DO NOT REMOVE OR COVER THIS LABEL.
NOT A SOURCE OF HEAT - NOT FOR USE WITH SOLID FUEL.
NON CONCU POUR CHAUFFAGE - NE DOIT PAS ÊTRE UTILISÉ AVEC UN COMBUSTIBLE SOLIDE.

BAR CODE
3 OF 9

Table of Contents

1 Listing and Code Approvals	
A. Appliance Certification	4
B. Table 1	4
2 Getting Started	
A. Size of Firebox	5
B. Negative Pressure	5
C. Tools and Supplies Needed	5
D. Inspect the Appliance and Components	5
E. Components of the Gas Hearth Kit	6
3 Appliance Preparation	
A. Gas Supply Connection	7
B. Convert to Left Side Gas Piping	7
C. Gas Pressure	8
4 Installation Instructions	
A. Install the Damper Stop	9
B. Install the Burner/Pan Assembly	9
C. Install the Grate	9
D. Place Sand and Rockwool	9
E. Install the Logs	10
F. Adjust the Burner Flame	10
G. Inspect the Venting System	10
5 Operating Instructions	
A. Lighting Instructions	11
B. Glass Doors	12
C. Important Safeguards	12
6 Maintaining and Servicing the Appliance	
A. Servicing Your Appliance	13
B. Cleaning Your Appliance	13
C. Annual Inspection	13
D. Troubleshooting	13
7 Reference Materials	
A. Replacement Parts	14
B. Owner Registration/Warranty	19
C. Contact Information	20

1 Listing and Code Approvals

A. Appliance Certification

The Real Wood Elite Series Gas Log Hearth Kits have been tested and listed in the U.S. in accordance with **ANSI Z21.84-2003** (Gas Log Set). They have been listed by Underwriters Laboratories Inc. for installation and operation in the United States and Canada as described in these Installation and Operating Instructions. All components are UL, AGA, CGA or CSA safety certified.

Check with your local building code agency prior to installing this appliance to ensure compliance with local codes, including the need for permits and follow-up inspections. In the absence of local codes, comply with the **National Fuel Gas Code, ANSI Z223.1-Latest Edition** in the U.S. If any assistance is required during installation, please contact your local dealer or call the Technical Services Department at 1-888-427-3973 or 1-800-927-6841.

WARNING

Improper installation, adjustment, alteration, service or maintenance can cause injury or property damage. Refer to the owner's information manual provided with this appliance. For assistance or additional information consult a qualified installer, service agency or the gas supplier.

WARNING



Fire Risk Exhaust Fumes Risk

- Do NOT use this appliance as a "vent-free" heater.



The flue must be permanently open. Refer to Table 1.

B. Table 1

Product		MTCH-18-B	MTCH-24-B	MTCH-30-B	MTCH-ST-18NG-B	MTCH-ST-24NG-B
Inlet BTU / KW /HR	Nat.	65,000 / 19	84,000	83,000	65,000 / 19	84,000
Max. Inlet Pressure IN. WC / KPa	Nat.	10.0 / .052	10 / .052	10 / .052	10.0 / .052	10.0 / .052
Min. Inlet Pressure IN. WC / KPa	Nat.	3.5 / .018	3.5 / .018	3.5 / .018	3.5 / .018	3.5 / .018
Orifice Size In. / mm	Nat.	(#20) .161	(#16) .177	(#16) .177	(#29) .136	(#17) .173
Minimum Fireplace Opening Size Inches	Front	18	24	30	20	26
	Rear	18	24	30	20	26
	Depth	16	16	16	16	16
	Height	16	16	16	16	16
Min. Vent Opening in Square Inches		39	48	48	39	48

2 Getting Started

A. Size of Firebox

See Table 1 in Section 1.B.

B. Negative Pressure

Negative pressure results from the imbalance of air available for the fireplace to operate properly. Causes for this imbalance include:

- Exhaust fans (kitchen, bath, etc.).
- Range hoods.
- Combustion air requirements for furnaces, water heaters and other combustion appliances.
- Clothes dryers.
- Location of return-air vents to furnace or air conditioning.
- Imbalances of the HVAC air handling system.
- Upper level air leaks: recessed lighting, attic hatch opening, duct leaks.

C. Tools and Supplies Needed

Tools and supplies normally required for installation:

Pliers

Phillips screwdriver

Tape measure

Crescent wrenches

Gas shutoff valve

Non-corrosive leak check solution



3/4 in. wrench, 7/16 in. wrench

D. Inspect the Appliance and Components

- Remove the contents from the carton. Attached to the burner are tags identifying the manufacturer name, serial number, model number (including gas log size), BTU ratings, gas type, etc.
- Review the attached tags before proceeding. Ensure that all minimum fireplace dimension requirements are achieved using Table 1 in Section 1.B. See Figure 2.1. Ensure the gas type provided in the fireplace coincide with the gas type marked on the tag.









Figure 2.1 Measure Firebox

	CAUTION	
	Sharp Edges	
	<ul style="list-style-type: none">• Wear protective gloves and safety glasses during installation.	

	WARNING
	Asphyxiation Risk
	This appliance produces carbon monoxide (CO).
	<ul style="list-style-type: none">• The free opening areas (in square inches) of the chimney damper as shown in the tables must be met.• User must make sure damper is locked open.• The installer is responsible to ensure proper ventilation of flue gases before appliance is used.
	Fire needs to draft properly for safe operation.

	WARNING
	Hearth & Home Technologies disclaims any responsibility for, and the warranty will be voided by, the following actions:
	<ul style="list-style-type: none">• Installation and use of any damaged appliance or vent system component.• Modification of the appliance or vent system.• Installation other than as instructed by Hearth & Home Technologies.• Improper positioning of the gas logs or the glass door.• Installation and/or use of any component part not approved by Hearth & Home Technologies.
	Any such action may cause a fire hazard.

	WARNING
	<p>Inspect appliance and components for damage. Damaged parts may impair safe operation.</p> <ul style="list-style-type: none"> • Do NOT install damaged components. • Do NOT install incomplete components. • Do NOT install substitute components.
	<p>Report damaged parts to dealer.</p>



	WARNING	
	<p>Keep appliance dry.</p> <ul style="list-style-type: none"> • Mold or rust may cause odors. • Water may damage controls. 	

E. Components of the Gas Hearth Kit

The Gas Log Hearth Kit consists of the following:

- Burner/Pan Assembly
- Grate Assembly
- Rock Wool
- Sand
- Lava Rock
- Damper Stop
- Aluminum Tubing Assembly
- Brass Elbow Connector
- Log Set - sold separately

	WARNING
<p>Do NOT use this appliance if any part has been under water. Immediately call a qualified service technician to inspect the appliance and to replace any part of the control system and any gas control which has been under water.</p>	



	WARNING
	<p>Shock Risk</p>
	<p>Fire Risk</p> <p>Use ONLY optional accessories approved for this appliance.</p> <ul style="list-style-type: none"> • Using non-listed accessories voids warranty. • Using non-listed accessories may result in a safety hazard. • Only Hearth & Home Technologies approved accessories may be used safely.

3 Appliance Preparation





Note: Have the gas supply line installed in accordance with local building codes, if any. If not, follow **ANSI 223.1**. Installation should be done by a qualified installer approved and/or licensed as required by the locality. (In the Commonwealth of Massachusetts installation must be performed by a licensed plumber or gas fitter.)

A. Gas Supply Connection

A 3/8 in. flared fitting has been installed on the gas valve inlet at the factory. Ensure fittings are of the appropriate size and type on the gas line connection. If the tubing has to be cut to length be sure to use the proper cutting and flaring tool. Also, be careful not to crimp the tubing while bending. If the tubing becomes crimped, do not use for installation.

	WARNING
	Gas Leak Risk <ul style="list-style-type: none">• Support control when attaching pipe to prevent bending gas line.



Gas resistant pipe compound must be used on all threaded male connections to ensure a tight seal.

	WARNING	
	Fire Risk Explosion Risk Personal Injury Risk	
	An explosion could occur if a connection is made directly to an unregulated propane (LP) tank.	

Note: An individual manual shutoff valve (not supplied) is required when installing this appliance. The manual shutoff valve must be located in an easily accessible area, no more than 6 feet from the appliance.

Note: A listed (and Commonwealth of Massachusetts approved) 1/2 in. (13 mm) T-handle manual shut-off valve and flexible gas connector are connected to the 1/2 in. (13 mm) control valve inlet.

- **If substituting for these components, please consult local codes for compliance.**

	WARNING
	Fire Risk Explosion Risk
	Verify inlet pressures. <ul style="list-style-type: none">• High pressure may cause overfire condition.• Low pressure may cause explosion. Install regulator upstream of valve if line pressure is greater than 1/2 psig.



B. Convert to Left Side Gas Piping

- Remove the brass elbow from the right side.
- Remove the brass plug from the left side.

Note: Prior to installing the fittings, use Teflon tape or joint compound on the male threads.



- Replace the brass plug on the opposite end of the burner tube.
- Install the valve shield brass elbow on the left side of the burner.





Note: Be sure when reassembling the burner assembly that the burner neck is properly positioned on the orifice.



	WARNING
	Fire Risk Explosion Risk
	<ul style="list-style-type: none">• Gas build-up during line purge may ignite.• Purge should be performed by qualified technician.• Ensure adequate ventilation.• Ensure there are no ignition sources such as sparks or open flames.



C. Gas Pressure

Proper input pressures are required for optimum appliance performance. Gas line sizing requirements need to be made following **NFPA51**.

 WARNING	
	<p>Fire Risk Explosion Risk</p> <p>High pressure will damage valve.</p> <ul style="list-style-type: none"> • Disconnect gas supply piping BEFORE pressure testing gas line at test pressures above 1/2 psig. • Close the manual shutoff valve BEFORE pressure testing gas line at test pressures equal to or less than 1/2 psig.
	

 WARNING	
	<p style="text-align: center;">CHECK FOR GAS LEAKS</p> <p>Fire Risk Explosion Risk Asphyxiation Risk</p> <ul style="list-style-type: none"> • Check all fittings and connections. • Do not use open flame. • After the gas line installation is complete, all connections must be tightened and checked for leaks with a commercially available, non-corrosive leak check solution. Be sure to rinse off all leak check solution following testing. <p>Fittings and connections may have loosened during shipping and handling.</p>
	
	

 WARNING	
	<p>Fire Risk Explosion Risk</p> <p>Do NOT change the valve settings.</p> <ul style="list-style-type: none"> • This valve has been preset at the factory. • Changing valve settings may result in fire hazard or bodily injury.
	

 WARNING	
	<p>Shock Risk Explosion Risk</p> <p>Do NOT wire 110V to valve. Do NOT wire 110V to wall switch</p> <ul style="list-style-type: none"> • Incorrect wiring will damage millivolt values.
	

- Gas Supply Pressure: Minimum inlet gas supply pressure must be 3.5 in. W.C. for the purpose of input adjustment. Maximum inlet gas pressure must not exceed 10.0 in. W.C. The gas line supplying the appliance must be sufficient size to furnish the appropriate supply pressure to the appliance while operating in the "High" setting. (Minimum line ID of 1/2 in. required if the line is longer than 20 ft.
- Pressure tap screws must be closed before turning gas on to the appliance.
- Gas Line Pressure Test: Perform pressure test according to state and local code (if pressure exceeds 1/2 in. psi [3.5 kPa]) before appliance is connected. Be sure to release air pressure from the gas line before connection is made to the appliance. Excessive pressure will damage the gas control and may cause a gas leak.
- Gas Leak Test: Make sure the gas connections are tight. Turn on the gas and coat each joint with a non-corrosive gas leak check solution. Air bubbles will form indicating any leaks. **DO NOT USE A FLAME OR ANY TYPE OF IGNITION SOURCE TO CHECK FOR LEAKS.** All leaks must be corrected before proceeding with installation.
- The appliance must only be installed in a solid-fuel burning fireplace *with the flue damper clamped open*. Refer to Table 1. The fireplace must be constructed of non-combustible material.
- The minimum permanent free opening (in square inches) that must be provided by the fireplace chimney or damper to vent the flue gases is provided in Table 1. If the free opening is smaller than the specified area, do not use this appliance.
- The damper must be removed or fixed in a manner in which will secure it open. Some jurisdictions require the damper to be removed or permanently welded fully open. Check with state and local codes.
- Be sure that the chimney is completely unobstructed to ensure proper ventilation of flue gases including carbon monoxide (CO). CO (a poisonous gas) is tasteless, odorless, colorless and undetectable without proper equipment.

High Altitude Derate

In the USA, input BTU shall be derated 4% (one orifice size) per 1000 feet for altitudes above 2000 feet. In Canada, input BTU shall be derated 10% (two orifice sizes) at altitudes from 2000-4500 feet.

CAUTION

- Prevent accidental appliance operation when not attended.
- Unplug or remove batteries from remote control if absent or if appliance will not be used for an extended period of time.
- Property damage possible from elevated temperatures.

4 Installation Instructions

A. Install the Damper Stop

- Open the damper to the fully open position and secure it open with the stop as shown in Figure 4.1.
- If the damper stop doesn't fit your application, use a permanent means that will keep the damper open at least to the minimum vent opening as outlined in Table 1, Section 1.B.

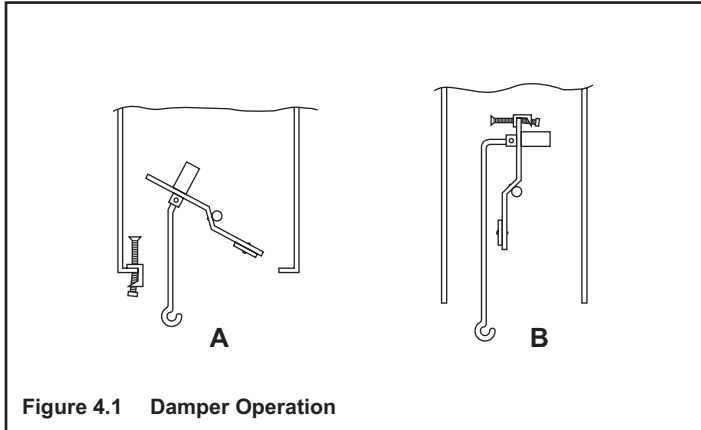

Figure 4.1 Damper Operation

B. Install the Burner/Pan Assembly

The burner/pan assembly is shipped ready for right-hand gas connection. See Section 3.B. for left-hand connection.

- Remove the existing cap or gas jet assembly from the gas stub in your fireplace. Clean the threads using a wire brush or steel wool. Apply Teflon tape or pipe dope to the steel fitting and attach the provided brass adapter to the stub.
- Place the burner/pan assembly in the fireplace. The pan should be centered both front to back and side to side.
- Bend the provided gas connector to facilitate its installation between the burner and the gas stub.
- Attach one end of the gas connector to the brass elbow or safety pilot fitting. Attach the other end to the brass adapter at the gas tube.

C. Install the Grate

- Center grate over burner pan. See Figure 4.2.
- Burner pan should be centered between front legs of grate. The front leg of the grate should be approximately even with the front burner tube. Refer to Figure 4.3.

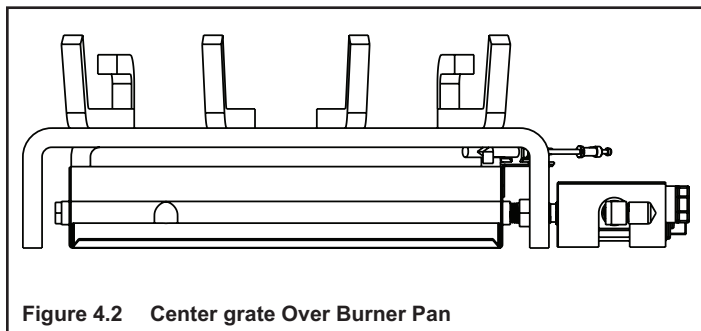

Figure 4.2 Center grate Over Burner Pan

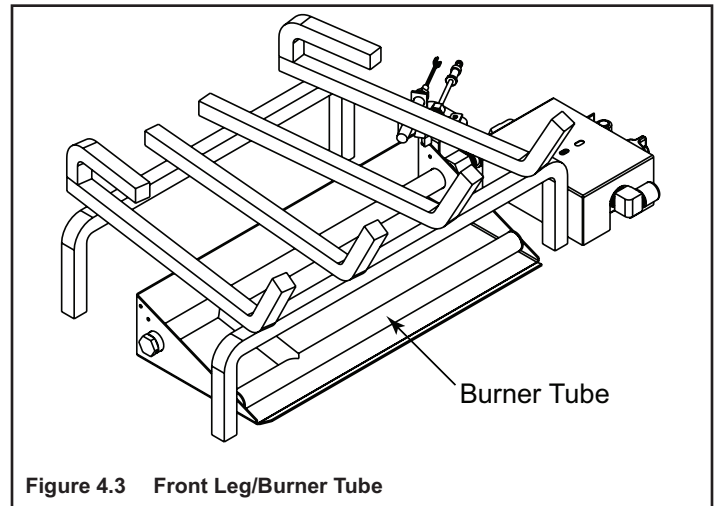

Figure 4.3 Front Leg/Burner Tube

D. Place Sand and Rockwool

- Pour the sand into the burner pan. Sand should follow the slope of pan, covering it and the burner tube completely.
- Allow the sand to spill out the front of the pan and over the sides onto the fireplace floor.

Important: Cover the pilot assembly to protect it before installing the sand or vermiculite.

Note: Use caution so vermiculite does not get into the air mixer on LP models.

- Lightly place dime-sized pieces of rockwool evenly on top of the sand or vermiculite.

⚠ WARNING

Explosion Risk





- Follow rockwool placement instructions in this manual.
- Do NOT place rockwool directly over burner ports.
- Replace rockwool material annually.

Improperly placed rockwool interferes with proper burner operation.

- **Inspect the pilot burner to ensure it is clear of any rock wool.**
- The gas burns at the point of the least resistance. In case of an uneven flame pattern it may be necessary to adjust the materials in the pans (using an object such as a screwdriver) to achieve the desired effect.

Note: For best results, do not pack down the rock wool. The placement of rock wool can have an effect on flame pattern and may need to be adjusted to achieve a desired appearance.

E. Install the Logs

	WARNING	
	Fire Risk Explosion Risk Personal Injury Risk	
	Failure to position the parts in accordance with the diagrams provided with the log packages or failure to use only parts approved with this appliance may result in property damage or personal injury.	

- Carefully remove the two base logs from the box. The shorter of the two base logs should be placed on the grate steps or at the rear of the grate. The longer of the two base logs should be centered on the front of the grate.

Note: If your log set comes with two burnt-out front logs, place these on the opposite sides of the grate.

- Light the burner as outlined in the operating section. Allow the flame pattern to stabilize. If you are satisfied with the flame pattern go to the next step. If you want more or less flame around the front log, turn off the gas and move the grate backward or forward.
- Once you are satisfied, turn on the gas and go on to the next step.
- Arrange the top logs as shown in your log set up instructions. Light the burner as outlined in the operating instructions and allow the flame to stabilize.
- Spread the lava rock around the outside of the burner pan on the floor of the fireplace. If possible, cover the gas connector with the cinders. **DO NOT** cover any part of the pilot assembly.

Note: If your log set is the burnt-out type, place the rock wool in the center of the logs to give a glowing ember effect.

F. Adjust the Burner Flame

- The burner flame can be adjusted at the manual shutoff valve beside the fireplace to obtain the desired heating output and flame appearance.
- The flame color will stabilize after ten minutes of operation.

G. Inspect the Venting System

The fireplace venting system is designed and constructed to develop a positive flow adequate to remove flue gases to the outside atmosphere. See fireplace installation instructions.

A spillage test must be made before the installed appliance is left with the consumer



- Close all doors and windows in the home.
- Light the log set.
- After three minutes, test with a smoke match, smoke candle, stick incense or cigarette one inch below the top of the opening (lintel) moving across the full width. If spillage (smoke drawn into the room) occurs, it will most likely be near the top, outside corners.

Possible Cures if Spilling Occurs

- The damper needs to be opened further.
- The fireplace opening needs to be reduced by adding a drop panel across the top under the lintel.
- The air supply from outdoors needs to be increased. Open the outside air kit if the appliance is so equipped, or crack open a door or window.
- If necessary, seek expert advice. Do not operate this appliance.

Cleaning

- Periodic examination and cleaning of the venting system of the fireplace should be done before initial use and at least annually by a qualified agency.

	WARNING
	Fire Risk Explosion Risk Inspect external vent cap regularly.
	<ul style="list-style-type: none">• Ensure no debris blocks cap.• Combustible materials blocking cap may ignite.• Restricted air flow affects burner operation.

5 Operating Instructions

A. Lighting Instructions

FOR YOUR SAFETY READ BEFORE LIGHTING

WARNING: If you do not follow these instructions exactly, a fire or explosion may result causing property damage, personal injury or loss of life.

- A. This appliance has a manually lighted burner, and must be lit by hand. When lighting the burner, follow these instructions exactly.
- B. BEFORE LIGHTING smell all around the appliance area for gas. Be sure to smell next to the floor because some gas is heavier than air and will settle to the floor.
- C. Do not use this appliance if any part has been under water. Immediately call a qualified service technician to inspect the appliance and to replace any part of the control system and any gas control which has been under water.

WHAT TO DO IF YOU SMELL GAS

- Do not try to light any appliance.
- Do not touch any electric switch; do not use any phone in your building.
- Immediately call your gas supplier from a neighbor's phone. Follow the gas supplier's instructions.
- If you cannot reach your gas supplier, call the fire department.

Due to high surface temperatures, keep children, clothing and furniture away.

Keep burner and control compartment clean. See installation and operating instructions accompanying the appliance.

FOR YOUR SAFETY: Do not store or use gasoline or other flammable vapors and liquids in the vicinity of this or any other appliance.

LIGHTING INSTRUCTIONS

1. STOP! Read the safety instruction label.
2. Turn the gas control manual valve to the full "OFF" position.
3. Wait five minutes to clear out any gas. If you smell gas, STOP! Follow "B" on the safety information label. If you don't smell gas, go to next step.
4. Place a burning match on the surface of the burning embers. Do not hold match in hand.
5. Turn gas control manual valve to the full "ON" position.
6. If appliance will not operate, follow the instructions "TO TURN OFF GAS TO APPLIANCE" and call your service technician or gas supplier.

TO TURN OFF GAS APPLIANCE



1. Turn gas control manual valve to full "OFF" position.

33321

B. Glass Doors

If your fireplace is equipped with glass doors:

- Glass doors should be in fully open position when appliance is operating.
- Operating in the closed position will block the radiant heat output and may cause incomplete combustion of the gas and minimize overheating of any valve installation.

	WARNING
	Fire Risk
	Explosion Risk
	Do not close the glass doors during appliance operation.
	<ul style="list-style-type: none">• Could cause incomplete combustion of the gas.



- Glass doors may be closed when the hearth kit is not being used.

C. Important Safeguards

- Other Fuels
 - Although your gas log set is very realistic in appearance, it is not a real woodburning fire and must not be used for burning any fuel other than natural or propane gas.
 - To avoid irreparable damage to the appliance and/or personal injury, wood, matches, paper, garbage or any other material must not be placed or thrown on top of the logs.
- Appliance Safety
 - To avoid personal injury, do not touch hot surfaces when the appliance is operating.
 - Always ensure that the fireplace screen is closed when the appliance is operating.
 - Close supervision is necessary when the appliance is being used near children.
- Do not remove any of the attached metal plates, which contain important safety and operating information.
- Keep the appliance area clear and free of all combustible materials, gasoline and other flammable vapors and liquids.

	WARNING
Do NOT use this appliance if any part has been under water. Immediately call a qualified service technician to inspect the appliance and to replace any part of the control system and any gas control which has been under water.	

- **A qualified service technician must perform installation and repair.** The appliance should be inspected and cleaned annually by a qualified service technician. More frequent cleaning may be required due to excessive lint, dust, pet hair, etc. It is imperative that the control compartments, burners and air passageways are unobstructed during operation.
 - Review proper placement of logs, rockwool, lava rock, sand or vermiculite.
 - Check the wiring.
 - Ensure there are no gas leaks.
 - Ensure the flow of combustion and ventilation air is not obstructed (front grilles and vent caps).
- Before installing into a solid fuel burning fireplace, the chimney and firebox should be inspected and cleaned to remove soot, creosote, ashes, paint, bird nests etc.
- Annual examination of the chimney must be performed by a qualified agency to ensure proper ventilation of flue gases created by this appliance.
- Have the chimney and adjacent structure inspected and cleaned by qualified professionals. Hearth & Home Technologies recommends that NFI certified professionals, or technicians under the direction of certified professionals, conduct a minimum of an **NFPA 211 Level 2** inspection of the chimney.
- Replace component parts of the chimney and fireplace as specified by the professionals.
- Ensure all joints are properly engaged and the chimney is properly secured.
- Do not allow fans to blow directly into the fireplace. Avoid any drafts that alter burner flame pattern.
- Do not use a blower insert, heat exchanger insert or other accessories not approved for use with this appliance. Solid fuels shall not be burned in a fireplace where a decorative appliance is installed.
- If glass doors are present, the **glass doors must be fully opened** while appliance is in operation.

	WARNING
	Fire Risk
	High Temperatures
	Keep combustible household items away from appliance.
	Do NOT obstruct combustion and ventilation air.
	<ul style="list-style-type: none">• Do NOT place combustible items on top of or in front of appliance.• Keep furniture, draperies away from appliance.

6 Maintaining and Servicing the Appliance

A. Servicing Your Appliance

 **WARNING**

Risk of injury or property damage

Before servicing:

- Turn off gas.
- Turn off electricity to appliance.
- Disable remote control, if one is present.
- Ensure appliance is completely cooled.

After Servicing:

- Replace any screen or barrier that was removed.
- Reseal and reinstall any venting removed for servicing.

- Repair and replacement work should be done by a qualified service technician.
- Always shut off the gas supply and make sure the appliance is cool before beginning any service operation.
- Always check for gas leaks after servicing.
- Always check for proper venting.

B. Cleaning Your Appliance

Your gas logs require little care. Keep the burner assembly, logs and burner area surrounding the logs clean by vacuuming or brushing with a dry paint brush at least twice a year.

- The logs become fragile after burning. Take care in handling.
- Always turn off the gas to the pilot before cleaning. For relighting, refer to lighting instructions located on pages 8-9 of these instructions.
- Always keep the appliance clear and free from combustible materials, gasoline, and other flammable vapors and liquids.
- Never obstruct the flow of combustion and ventilation air. Keep the front of the appliance clear of all obstacles and materials.
- Leave clearance of at least 36 in. from the front of the fireplace.
- The air shutter should not be blocked.

 **CAUTION**

- Logs can get very hot. Handle only when they are cool.

C. Annual Inspection

 **WARNING**



Annual inspection by qualified technician recommended.

Check:

- Condition of doors, surrounds and fronts.
- Obstructions of combustion and ventilation air.
- Condition of logs.
- Condition of firebox.
- Gas connections and fittings.
- Obstructions of termination cap.

Clean:

- Glass.
- Logs.
- Burner, burner ports.

Risk of:

- Fire
- Delayed ignition or explosion
- Exposure to combustion fumes
- Odors

D. Troubleshooting

With proper installation and maintenance, your new decorative gas appliance should provide years of trouble-free service. If you do experience a problem, refer to the troubleshooting guide below. This guide will assist you or a qualified service technician in the diagnosis of problems and the corrective action to be taken.

Symptoms	Possible Causes	Corrective Action
1. A match will not light the main burner; no gas to the main burner	A. Main gas shutoff valve is closed	1. Make sure the shutoff valve located on the incoming gas line is open.
	B. There is air in the gas line.	1. Bleed air from the gas line; wait five minutes and attempt to relight the main burner.
	C. No gas supply to the appliance.	1. Check the plumbing to ensure the appliance has been hooked up to the gas supply line.
	D. A blockage is preventing gas flow.	1. Inspect the burner orifice for obstruction. Call a qualified service technician.

7 Reference Materials

A. Replacement Parts



Service Parts

RW ELITE HEARTH KITS

Exploded Parts Diagram
MTCH-NG

Beginning Manufacturing Date: 03/04
Ending Manufacturing Date: Active

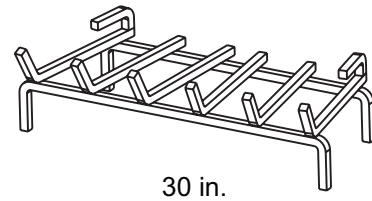
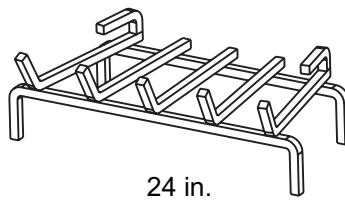
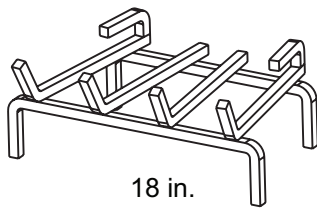
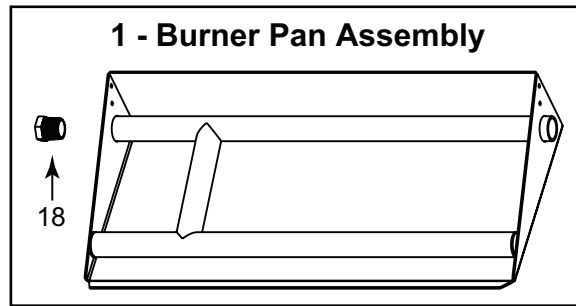

2 - Grate Assembly

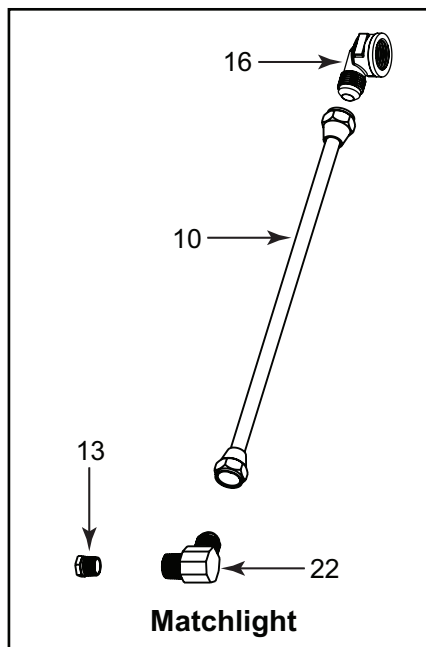

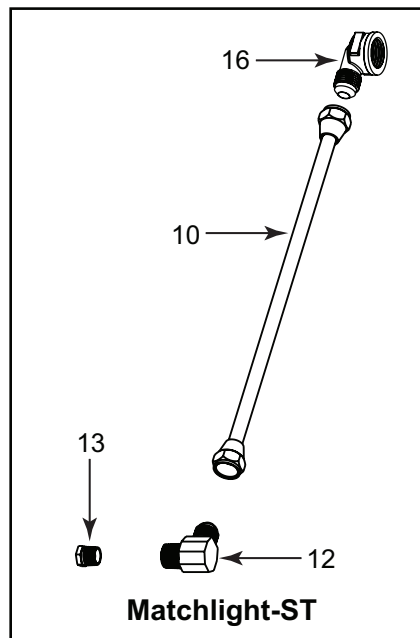
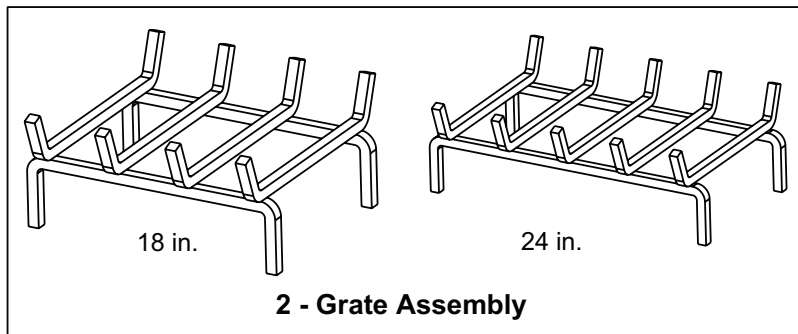
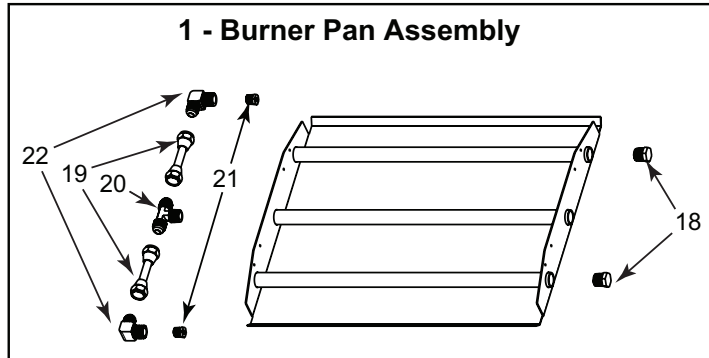

This page intentionally left blank.

B. Owner Registration/Warranty

Please complete and return your owner registration card to ensure proper warranty coverage. If you wish to communicate with the factory, write to Technical Service Dept., Hearth & Home Technologies Inc., 1915 W. Saunders Street, Mt. Pleasant, Iowa 52641.

DECORATIVE GAS LOG LIMITED WARRANTY

Hearth & Home Technologies Inc. (HHT) extends the following warranty for decorative gas log sets as described herein, while it is in its location or original installation. Dealers and employees of **HHT** have no authority to make any warranty or authorize any remedies in addition to or inconsistent with the terms of this Program. This warranty gives you specific legal rights. You may also have other rights which vary from state to state.

LIMITED WARRANTY. This decorative gas log set is comprised of a gas burner assembly with safety pilot valve and ceramic fiber logs that are manufactured by **HHT**. This Limited Warranty does not cover any part of the woodburning fireplace system in which this decorative gas appliance must be installed. This decorative gas log set is warranted to be free of defects in material and workmanship for a period of five (5) years from the date of installation. This Limited Warranty extends only to decorative gas log sets installed in the United States or Canada.

EXCLUSIONS AND QUALIFICATIONS. This Limited Warranty is subject to the following exclusions and qualifications: (1) This Limited Warranty does not apply to, and **HHT** assumes no responsibility for, any damages that result due to the installation or operation of this decorative gas log set not in accordance with both the installation instructions and operating instructions furnished. (2) The decorative gas log set must be subjected to normal use as explained in the operating instructions and the listing agency identification label attached to the burner pan assembly. This decorative gas log set is only intended to burn the fuel specified on the listing agency identification label. Use of any other fuel other than specified on the listing agency identification label can create a life threatening situation and will void this limited warranty. (3) This Limited Warranty applies only if the decorative gas log system has been installed in a vented fireplace that is suitable for burning wood. Adequate ventilation must be provided to allow proper drafting of the fireplace chimney system. **HHT** assumes no responsibility for improper performance of the decorative gas log set caused by inadequate draft due to environmental conditions (e.g. wind currents, downdrafts), tight-sealing construction of the structure, or mechanical devices (e.g. air handling devices that include forced air furnaces and air conditioning units, exhaust fans and ventilating devices), any and all of which may cause a negative pressure within the structure where the decorative gas log set is installed. (4) This Limited Warranty applies only to the components of the Appliance manufactured by **HHT**. **HHT** expressly excludes from this Limited Warranty any liability hereunder for defects or damage caused by the installation or use of any parts, devices or components that are not manufactured by **HHT**. (5) Labor costs to be paid by **HHT** pursuant to this Limited Warranty must be approved in advance of the performance of the work by **HHT** and must not exceed the retail price of the replacement part. (6) This Limited Warranty will be voided if the decorative gas log set is at any time removed or has been removed from the location in which it was originally installed. (7) Since building code requirements vary greatly throughout the United States and Canada, users of this decorative gas log set should determine in advance whether there are any building code restrictions on the installation and use of this product. **HHT** makes no representation or warranty regarding building code compliance and shall not be responsible for compliance therewith.

THERE ARE NO IMPLIED WARRANTIES OF MERCHANTABILITY OR FITNESS FOR PARTICULAR PURPOSE LIMITATION OF LIABILITY. IT IS EXPRESSLY AGREED AND UNDERSTOOD THAT HHT'S OBLIGATION AND PURCHASERS EXCLUSIVE REMEDY UNDER THIS LIMITED WARRANTY, UNDER ANY OTHER WARRANTY, EXPRESSED OR IMPLIED (INCLUDING MERCHANTABILITY AND FITNESS FOR PARTICULAR PURPOSE), OR OTHERWISE, SHALL BE LIMITED TO THE REPLACEMENT OR REPAIR OF ONLY HHT BRAND COMPONENTS AND OPTIONAL COMPONENTS AS SPECIFIED ABOVE. THE DURATION OF ANY IMPLIED WARRANTY INCLUDING MERCHANTABILITY AND FITNESS FOR PARTICULAR PURPOSE APPLICABLE TO THIS GAS APPLIANCE IS LIMITED TO THE DURATION OF THE FOREGOING WARRANTY. SOME STATES DO NOT ALLOW LIMITATIONS ON HOW LONG AN IMPLIED WARRANTY LASTS SO THE ABOVE WARRANTY MAY NOT APPLY TO YOU. IN NO EVENT SHALL HHT BE RESPONSIBLE FOR ANY INCIDENTAL OR CONSEQUENTIAL DAMAGES CAUSED BY DEFECTS IN THE DECORATIVE GAS LOG SET, WHETHER SUCH DAMAGE OCCURS OR IS DISCOVERED BEFORE OR AFTER REPLACEMENT OR REPAIR, AND WHETHER SUCH DAMAGE IS CAUSED BY HHT NEGLIGENCE. SOME STATES DO NOT ALLOW THE EXCLUSION OR LIMITATION OF INCIDENTAL OR CONSEQUENTIAL DAMAGES, SO THE ABOVE LIMITATION OR EXCLUSION MAY NOT APPLY TO YOU.

HOW TO OBTAIN SERVICE. To obtain service under this Program, you must:

1. Send written notice of the claimed condition to the Technical Service Department, Hearth & Home Technologies Inc., 1915 West Saunders Street, Mt. Pleasant, Iowa 52641.
2. Provide proof of purchase to **HHT**.
3. Provide **HHT** reasonable opportunity to investigate the claim, including reasonable opportunity to inspect the Fireplace prior to any repair or replacement work and before the Fireplace has been removed from the place of original installation.
4. Obtain **HHT's** consent to any warranty work before the work is done.

ADDITIONAL INFORMATION. If you would like information on current Hearth & Home Technologies products or want to locate a dealer in your area, simply call 800-843-2848.

2003 Hearth & Home Technologies Inc., a Division of HON Industries

