

**Models:**

**CF230E-B**

**CF260E-B**

**Electric Fireplace/Insert**

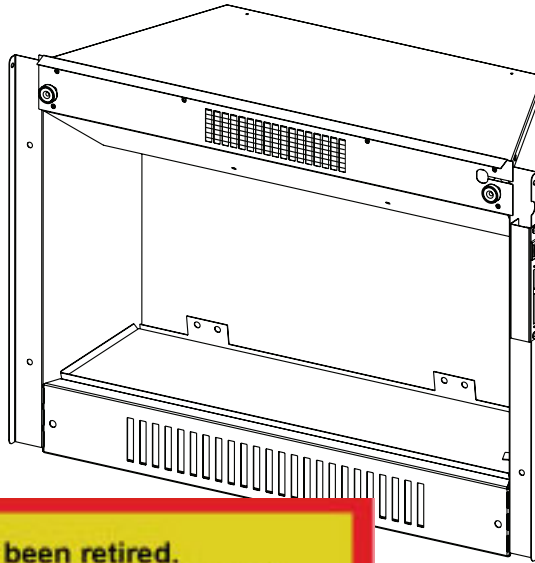

**This appliance has been retired.  
Service parts pages within have been removed.  
For replacement parts, please refer to the individual  
service parts list located on the brand websites.**

### CAUTION



#### DO NOT DISCARD THIS MANUAL

- Important operating and maintenance instructions included.
- Read, understand and follow these instructions for safe installation and operation.
- Leave this manual with party responsible for use and operation.



### ⚠ WARNING



**If the information in these instructions is not followed exactly, a fire may result causing property damage, personal injury, or death.**

- Do not store or use gasoline or other flammable vapors and liquids in the vicinity of this or any other appliance.
- Comply with all minimum clearances to combustibles as specified. Failure to comply may cause house fire.

Made in China

### ⚠ WARNING



**HOT! DO NOT TOUCH.  
SEVERE BURNS MAY RESULT.  
CLOTHING IGNITION MAY RESULT.**



Glass and other surfaces are hot during operation and cool down.

- Keep children away.
- CAREFULLY SUPERVISE children in same room as heater.
- Alert children and adults to hazards of high temperatures.
- Keep clothing, furniture, draperies and other combustibles away.

**Read this manual before installing or operating this heater.  
Please retain this owner's manual for future reference.**

### ***Congratulations!***

Congratulations on selecting a Heat & Glo electric fireplace/insert. The insert you have selected is designed to provide the utmost in safety, reliability and efficiency.

As the owner of a new fireplace/insert, you'll want to read and carefully follow all of the instructions contained in this owner's manual. Pay special attention to all cautions and warnings.

This owner's manual should be retained for future reference. We suggest you keep it with your other important documents and product manuals.

The information contained in this owner's manual unless noted otherwise, applies to all models.

Your new Heat & Glo electric fireplace/insert will give you years of durable use and trouble-free enjoyment. Welcome to the Heat & Glo family of fireplace products!

#### **Homeowner Reference Information**

*We recommend that you record the following pertinent information about your heater:*

Model Name: \_\_\_\_\_ Date purchased/installed: \_\_\_\_\_

Serial Number: \_\_\_\_\_ Location on heater: \_\_\_\_\_

Dealership purchased from: \_\_\_\_\_ Dealer phone: \_\_\_\_\_

Notes: \_\_\_\_\_

\_\_\_\_\_

\_\_\_\_\_

#### **Listing Label Information/Location**

The model information regarding your specific heater can be found on the rating plate located in the upper left corner of the front of the heater.

Heater Model

Serial #

Hearth & Home Technologies Inc.  
1915 W. Saunders Street  
Mt. Pleasant, IA 52641  
UL 2021 FIXED AND LOCATION  
DEDICATED ELECTRIC ROOM HEATER  
**MODEL XXXX DATE**  
**SERIAL XXXXXXXX**

**UL** US  
**LISTED**  
Made in China  
VOLTS: 120V  
WATTS: 1500W  
FREQUENCY: 60Hz

# Table of Contents

<b>1 Listing and Code Approvals</b>		<b>8 Troubleshooting</b>	
A. Certification . . . . .	4	A. Troubleshooting Guide . . . . .	16
B. Important Instructions . . . . .	4	<b>9 Maintenance and Service</b>	
<b>2 Getting Started</b>		A. Access the Firebox . . . . .	17
A. Design and Installation Considerations . . . . .	5	B. Clean the Firebox Compartment . . . . .	17
B. Tools and Supplies Needed . . . . .	5	C. Clean the Back Glass . . . . .	17
C. Inspect Heater and Components . . . . .	5	D. Replace the Light Bulbs . . . . .	17
<b>3 Framing and Clearances</b>		E. Maintenance Task List . . . . .	18
A. Selecting Heater Location . . . . .	6	<b>10 Reference Materials</b>	
B. Clearances . . . . .	6	A. Heater Dimensions . . . . .	19
C. Frame the Heater . . . . .	8	B. Optional Components . . . . .	20
<b>4 Installation</b>		C. Service Parts . . . . .	22
A. As a Fireplace . . . . .	9	D. Limited Warranty . . . . .	25
B. As an Insert . . . . .	10	E. Contact Information . . . . .	26
C. Wiring . . . . .	11		
<b>5 Accessories</b>			
A. Install the Front Face . . . . .	13		
B. Install other Optional Accessories . . . . .	13		
<b>6 Finishing</b>			
A. Finishing Material . . . . .	14		
B. Finishing Checklist . . . . .	14		
C. Mantel . . . . .	14		
<b>7 Operating Instructions</b>			
A. Main Power Switch . . . . .	15		
B. Thermostat . . . . .	15		

**Note:** An arrow (➡) found in the text signifies change in content.



# 1 Listing and Code Approvals

## A. Certification

This heater has been tested in accordance with the **UL2021 Standards** for fixed and location-dedicated electric room heaters in the United States, the current **CSA C22.2 No. 46** in Canada and has been listed by Underwriters Laboratories Inc. for installation as described in this manual. All components are **UL** or **CSA** safety certified.

This heater has been tested and listed for use with the optional components specified in this manual. These optional components may be purchased separately and installed at a later date.

Heat & Glo is a registered trademark of Hearth & Home Technologies Inc.

 <b>WARNING</b>
 <b>Fire Risk</b>
<ul style="list-style-type: none"><li>• <b>Do not</b> install or operate damaged heater.</li><li>• <b>Do not</b> modify heater.</li><li>• Installation other than as instructed by Hearth &amp; Home Technologies Inc. is strictly prohibited.</li><li>• <b>Do not</b> operate the heater without fully assembling all components.</li><li>• Installation and/or use of any component part not approved by Hearth &amp; Home Technologies.</li></ul>
Hearth & Home Technologies disclaims any responsibility for, and the warranty and agency listing will be voided by the above actions.

## ➔ B. Important Instructions

When using electrical heaters, basic precautions should always be followed to reduce the risk of fire, electric shock, and injury to persons, including the following:

- Read all instructions before using this heater.
- This heater is hot when in use. To avoid burns, do not let bare skin touch hot surfaces. If provided, use handles when moving this heater. Keep combustible materials, such as furniture, pillows, bedding, papers, clothes, and curtains at least 12 in. (305 mm) from the front of the heater and keep them away from the sides and rear.
- Extreme caution is necessary when any heater is used by or near children or invalids and whenever the heater is left operating and unattended.
- Always unplug heater when not in use.
- Do not operate any heater with a damaged cord or plug or after the heater malfunctions, has been dropped or damaged in any manner. Return heater to authorized service facility for examination, electrical or mechanical adjustment, or repair.
- Do not use outdoors.

## **WARNING**

Improper installation, adjustment, alteration, service or maintenance can cause injury or property damage. Refer to the owner's information manual provided with this heater. For assistance or additional information consult a qualified installer, service agency or your dealer.

## **Not intended for use as a primary heat source.**

This heater is tested and approved as a decorative heater. It should not be factored as a primary heat source in residential heating calculations.

- This heater is not intended for use in bathrooms, laundry areas and similar indoor locations. Never locate heater where it may fall into a bathtub or other water container.
- Do not run cord under carpeting. Do not cover cord with throw rugs, runners, or the like. Arrange cord away from traffic area and where it will not be tripped over. Do not coil cord.
- To disconnect heater, turn controls to "OFF", then remove plug from outlet.
- Do not insert or allow foreign objects to enter any ventilation or exhaust opening as this may cause an electric shock or fire, or damage the heater.
- To prevent a possible fire, do not block air intakes or exhaust in any manner.
- A heater has hot and arcing or sparking parts inside. Do not use it in areas where gasoline, paint, or flammable liquids are used or stored.
- Use this heater only as described in this manual. Any other use not recommended by the manufacturer may cause fire, electric shock, or injury to persons.
- Avoid the use of an extension cord because the extension cord may overheat and cause a risk of fire. However, if you have to use an extension cord, the cord shall be No. 16 AWG minimum size and rated not less than 1875 watts. Use minimum length and do not coil cord.
- Always use properly grounded fused and polarized outlets.
- Always use ground fault protection where required by electrical code.
- Always disconnect power before performing any cleaning, maintenance or relocation of the heater.
- To prevent a possible fire, do not burn wood or other materials in this heater.
- To prevent electric shock or fire, always use a certified electrician should new circuits or outlets be required.
- When transporting or storing the heater, keep in a dry place free from excessive vibration and store as to avoid damage.
- **SAVE THESE INSTRUCTIONS FOR FUTURE REFERENCE.**

# 2 Getting Started

## A. Design and Installation Considerations

### CAUTION

- Check building codes prior to installation.
- Installation **MUST** comply with local, regional, state and national codes and regulations.
  - Consult insurance carrier, local building inspector, fire officials or authorities having jurisdiction about restrictions, installation inspection, and permits.

When planning a heater installation, it is necessary to determine the following information before installing:

- Where the heater is to be installed. See Sections 3 and 4.
- Electrical wiring. See Section 4.
- Framing and finishing details. See Sections 3 and 6.
- Whether optional accessories—devices such as a fan, wall switch or remote control—are desired. See Section 10.

## B. Tools and Supplies Needed

Before beginning the installation be sure the following tools and building supplies are available:

Reciprocating saw	Framing material
Pliers	Wall-finishing materials
Hammer	Gloves
Phillips screwdriver	Framing square
Flat blade screwdriver	Electric drill and bits
Plumb line	Safety glasses
Level	Tape measure
Surround	
1/2-3/4 in. length, #6 or #8 self-drilling screws	
Misc. screws and nails	

### CAUTION

- Keep heater dry.
- Mold or rust may cause odors.

**Note:** Minimum and maximum clearances must be maintained at all times. Illustrations throughout these instructions reflect typical installations and are for design purposes only. Actual installation may vary slightly due to individual design preferences.

The illustrations and diagrams used throughout these installation instructions are not drawn to scale.

## C. Inspect Heater and Components

### CAUTION



#### Sharp Edges

- Wear protective gloves and safety glasses during installation.



### WARNING



#### Fire Risk

- Inspect heater and components for damage. Damaged parts may impair safe operation.
- Do NOT install damaged components.
  - Do NOT install incomplete components.
  - Do NOT install substitute components
- Report damaged parts to dealer.

- Carefully remove the heater and components from the packaging.
- Report to your dealer any parts damaged in shipment.
- **Read all the instructions before starting the installation. Follow these instructions carefully during the installation to ensure maximum safety and benefit.**

# 3 Framing and Clearances

	<b>⚠ WARNING</b>
	<b>Fire Risk</b> Provide adequate clearances. <ul style="list-style-type: none"><li>• Around air openings</li><li>• To combustibles</li><li>• For service access.</li></ul> Locate heater away from traffic areas.

<b>Note:</b> <ul style="list-style-type: none"><li>• Illustrations and photos reflect typical installations and are <u>FOR DESIGN PURPOSES ONLY</u>.</li><li>• Illustrations/diagrams are not drawn to scale.</li><li>• Actual installation/appearance may vary due to individual design preference.</li><li>• Hearth &amp; Home Technologies reserves the right to alter its products.</li></ul>
---

## A. Selecting Heater Location

Several options are available to you when choosing a location for your heater. This heater may be used as a room divider, installed along a wall, across a corner or used in an exterior chase. See Figure 3.1. This heater may be installed directly on the floor, carpet or raised on a hearth.

## B. Clearances

Figure 3.1 shows all clearances that must be maintained around the heater.

	<b>⚠ DANGER</b>
	<b>Electrocution Risk</b> <ul style="list-style-type: none"><li>• <b>NEVER</b> locate this heater where it may fall into a bathtub or other water container.</li></ul>

	<b>⚠ WARNING</b>
	<b>Fire Risk</b> Due to high temperature, this heater should be located out of high traffic areas. <ul style="list-style-type: none"><li>• Keep combustible materials such as furniture, pillows, bedding, papers, clothes and curtains at least 12 in. (305 mm) from the front of the heater.</li></ul>

	<b>⚠ WARNING</b>
	<b>Fire Risk!</b> <ul style="list-style-type: none"><li>• Prevent contact with sagging, loose insulation.</li><li>• Do NOT install against vapor barriers or exposed insulation.</li></ul>

<b>⚠ WARNING</b>
Do NOT use this heater if any part has been under water. Immediately call a qualified service technician to inspect the heater and to replace any part of the control system which has been under water.

**⚠ WARNING**

**Fire Risk**

- Comply with all minimum clearances to combustibles as specified.

Failure to comply may cause fire.

**Note:** Minimum and maximum clearances must be maintained at all times. Illustrations throughout these instructions reflect typical installations and are for design purposes only. Actual installation may vary slightly due to individual design preferences.

The illustrations and diagrams used throughout these installation instructions are not drawn to scale.

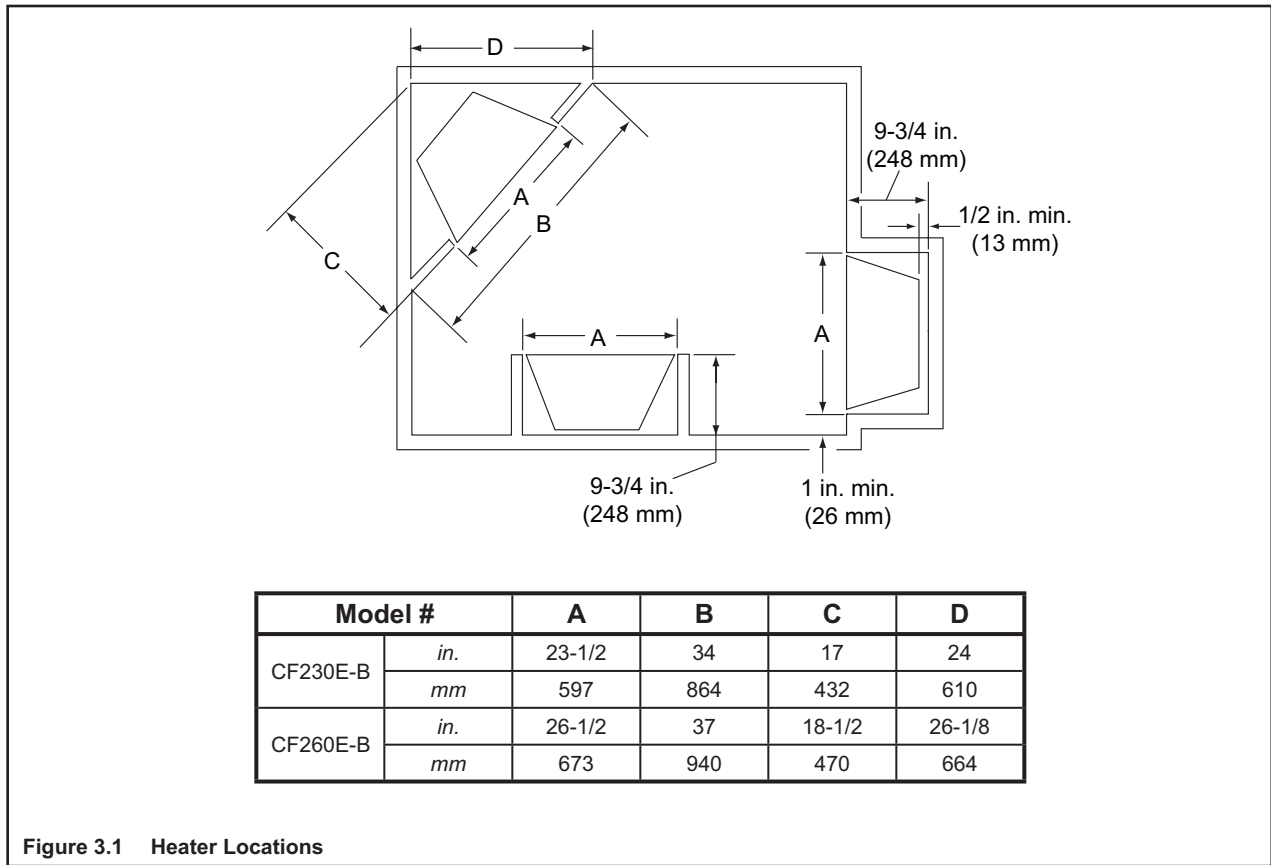

Figure 3.1 Heater Locations

### C. Frame the Heater

Figure 3.2 shows a typical framing (using 2 x 4 lumber) of the heater, assuming combustible materials are used. All required clearances to combustibles around the heater must be adhered to.

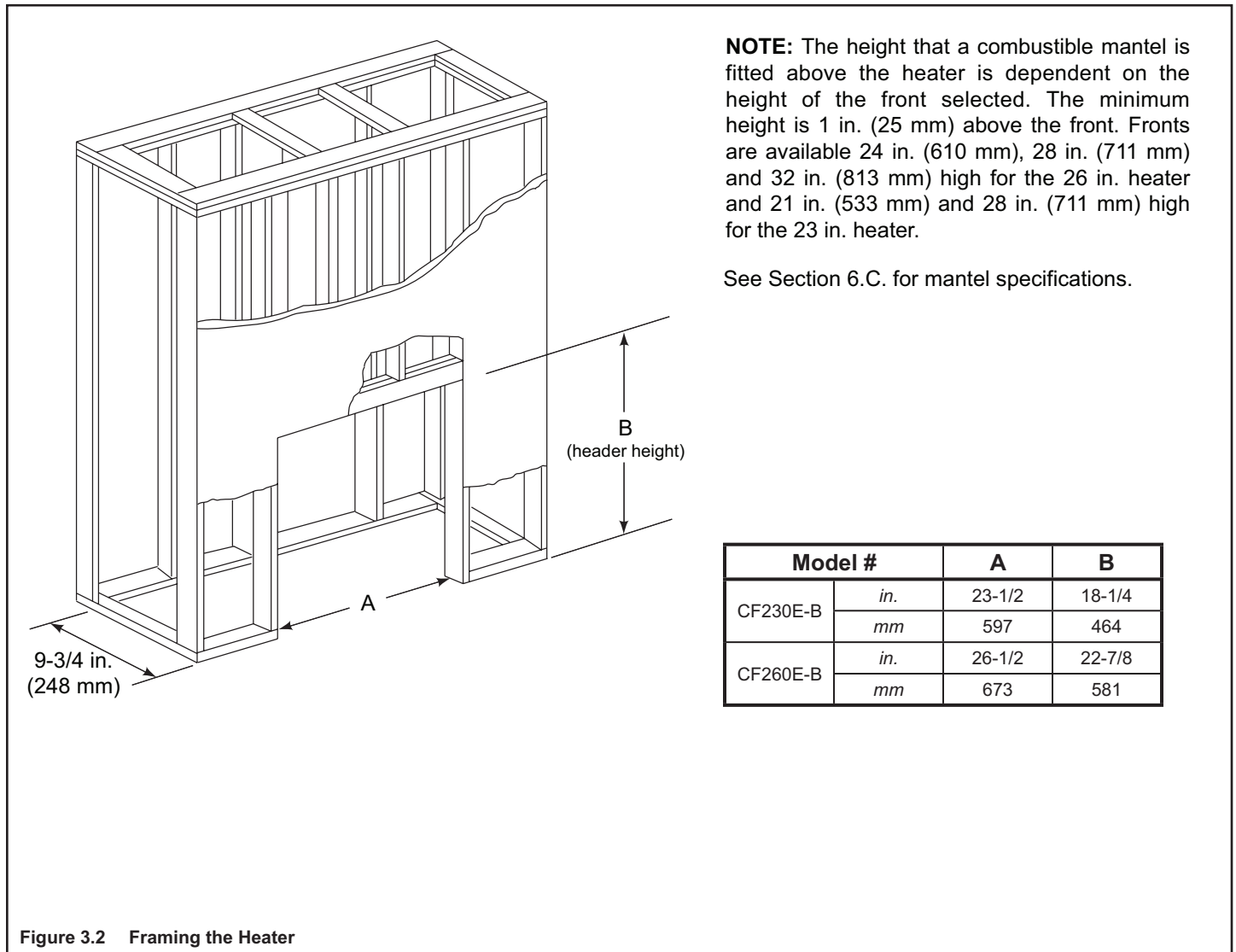



Figure 3.2 Framing the Heater



# 4 Installation

**CAUTION**



**Sharp Edges**

- Wear protective gloves and safety glasses during installation.

**WARNING**





**Shock Risk**

Improperly grounded outlets could cause electrical shock.

- Always use properly grounded, fused and polarized outlets.
- Always use ground fault protection where required by electrical code.

**WARNING**



**Shock Risk**  
**Fire Risk**

Improperly protected power cords could cause electrical shock or fire.

- Do not pinch the cord or lay against a sharp object.
- Do not cover the cord with carpeting, throw rugs or runners.
- Secure and arrange cord to avoid a tripping hazard.
- Do not coil cord.

## A. As a Fireplace

Select a suitable location that is not susceptible to moisture and is away from drapes, furniture and high traffic areas.

**Note:** Follow all national and local electrical codes.

## Wall Cabinet Kit, Corner Cabinet Kit or Custom Cabinet Installation

**The Cabinet must provide access to the wall outlet.**

- For ease of electrical hookup, you may wish to install the heater near an existing outlet. A 15 amp, 120 volt circuit is required. A dedicated circuit is preferred but not essential in all cases. A dedicated circuit will be required if, after installation, the circuit trips or fuse blows on a regular basis while the heater is operating. Additional heaters on the same circuit may exceed the current rating of the circuit breaker.
- If using a wall cabinet or corner cabinet, refer to the installation instructions supplied with the kit. For custom cabinets, frame and construct with the opening and depth dimensions listed in Figures 3.1 and 3.2.
- Before plugging the heater into the wall outlet, make sure all control switches are in the "OFF" position.
- Before finishing the cabinet, the heater must be set into the cabinet and the power cord routed to the electrical outlet. If the power cord does not reach the outlet, a No. 16-AWG minimum wire size extension cord rated for a minimum of 1875 watts may be used. Use minimum length and do not coil cord.
- To complete the heater installation, refer to Section 5.



## Non-Cabinet or Chase Installation

- Follow recommended framing dimensions in Figures 3.1 and 3.2.
- Set the heater into the framed opening. Secure the heater in place using the nailing flanges on both sides of the heater and nail to the framing.
- To finish out the heater, follow the instructions found in Section 6.
- To complete heater installation, see Section 5.

## B. As an Insert

### Pre-installation Preparation

This insert and its components are tested and safe when installed in accordance with this manual. Report to your dealer any parts damaged in shipment, particularly the condition of the glass. **Do not install any heater with damaged, incomplete or substitute parts.**

 <b>WARNING</b>
 <b>Fire Risk</b>
<ul style="list-style-type: none"><li>• <b>Do not</b> install or operate damaged heater.</li><li>• <b>Do not</b> modify heater.</li><li>• Installation other than as instructed by Hearth &amp; Home Technologies Inc. is strictly prohibited.</li><li>• <b>Do not</b> operate the heater without fully assembling all components.</li><li>• Installation and/or use of any component part not approved by Hearth &amp; Home Technologies.</li></ul>
Hearth & Home Technologies disclaims any responsibility for, and the warranty and agency listing will be voided by the above actions.

### Installation

- These inserts are designed for installations into solid fuel masonry or factory built noncombustible fireplaces that have been installed in accordance with the national, provincial, state or local building codes.
- You should seal off the area between the termination cap and the top of the existing chimney opening to avoid down drafts, moisture and/or cold air problems.
- Minimum fireplace opening requirements are shown in Figures 3.1 and 3.2 of this installation manual. The firebrick (refractory) can be removed from a factory built fireplace in order to gain minimum insert opening requirements.
- This insert requires no hearth extensions. Combustible material on the floor may be installed up to the insert. Do not obstruct the lower grill of the insert. The original fireplace cannot be returned to solid fuel in this condition.
- The metal floor of the solid fuel firebox may be removed to facilitate the installation of the insert. The side walls and top structure of the firebox may not be altered with the exception of removable baffles and dampers. The original fireplace cannot be returned to solid fuel in this condition.
- Position, Level and Secure Insert
  - Place the heater into position.
  - Level the heater from side to side and from front to back. If necessary, use the leveling bolts included in the manual bag. Screw the bolts into the nuts installed in the bottom of the insert (see replacement parts diagram). Turn bolts in until the insert is level.

- A retaining method may be needed to secure the heater in place.
- Combustible facing material may be installed over the original combustible or noncombustible facing material on the solid fuel fireplace. The original specified clearances of a factory-built fireplace must be maintained, with the exception of the hearth. Clearances on a masonry fireplace must be maintained at 12 in. from the opening for combustible projections over 1-1/2 in. Clearances for combustible projections under 1-1/2 in. must be maintained per **NFPA 211**. Plan the surround size accordingly. A front face must be used with the insert.
- The insert front face is tested and approved with this insert and may cover existing air circulation vents or grilles on the solid fuel fireplace it is installed into. Should the face not cover the entire ventilation grille surface, the grille should be left open.
- The solid fuel fireplace's flue damper must be fully locked in the closed position or removed for installation.

**Note:** Decorative trim front faces have been tested and approved to cover existing air circulation vents or grills.

- The chimney must be capped.
- Install the insert without the front face and make all electrical connections.

 <b>WARNING:</b>
THE SOLID FUEL/GAS FIREPLACE HAS BEEN CONVERTED FOR USE WITH AN ELECTRIC INSERT AND CANNOT BE USED FOR ORIGINAL FUELS UNLESS ALL ORIGINAL PARTS HAVE BEEN REPLACED AND THE FIREPLACE HAS BEEN REAPPROVED BY THE AUTHORITY HAVING JURISDICTION.

**Note:** The warning label above, located in the instruction package, must be affixed to the lower back wall of the existing fireplace prior to installation of the insert.

**Note:** When the front is installed it will cover the gap between the heater and the framing, cabinet, finishing materials or existing fireplace.

## C. Wiring

**Note:** This heater must be electrically wired and grounded in accordance with local codes or, in the absence of local codes, with **National Electric Code ANSI/NFPA 70-latest edition** or the **Canadian Electric Code, CSA C2.1** as appropriate.

**All wiring must be done by a qualified electrician. Use appropriate wire to meet local and national codes for rated power consumption.**

### CAUTION

Label all wires prior to disconnection when servicing controls. Wiring errors can cause improper and dangerous operation. Verify proper operation after servicing.

- A dedicated circuit is preferred but not essential in all cases. A dedicated circuit will be required if, after installation, the circuit trips or fuse blows on a regular basis when the heater is operated. Additional appliances on the same circuit may exceed the current rating of the circuit breaker.
- The heater is wired from the factory with a polarized plug. No provisions have been made for hardwiring.
- For ease of electrical hook up, you may wish to install the heater near an existing outlet. A 15 amp, 120 volt circuit is required.
- Run the cord out the notch of the front face.
- Before plugging the heater into the wall outlet, make sure the control switch is in the "OFF" position.
- ➡ • If the cord does not reach the outlet, a No. 16-AWG minimum wire size extension cord rated for a minimum of 1875 watts may be used. Use minimum length and do not coil cord.
- If installing inside a pre-existing fireplace and if permitted by local codes, an electrician may install an outlet box inside the existing fireplace. Place the outlet in the lower back of the firebox.

### ⚠ WARNING



#### Shock Risk

Improperly grounded outlets could cause electrical shock.

- Always use properly grounded, fused and polarized outlets.
- Always used ground fault protection where required by electrical code.

### CAUTION

Disconnect remote controls during your extended absence. This will prevent accidental operation of the heater.

Model	Description	Voltage	Watts	Amps (120/208/240)
CF230E-B	23 in. fireplace/insert	120	1500	12.5
CF260E-B	26 in. fireplace/insert	120	1500	12.5

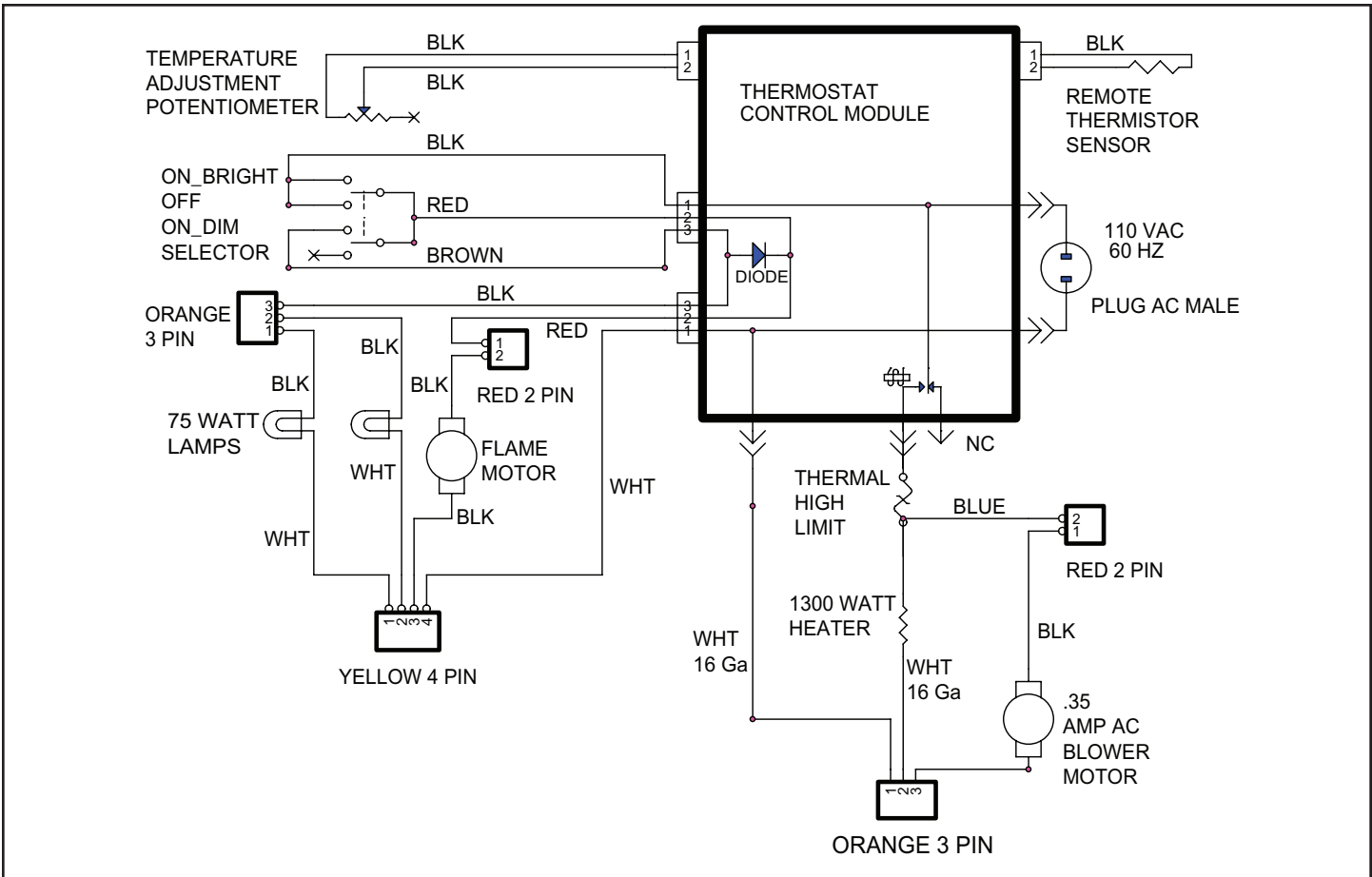

Figure 4.1 110V/120V Wiring Diagram

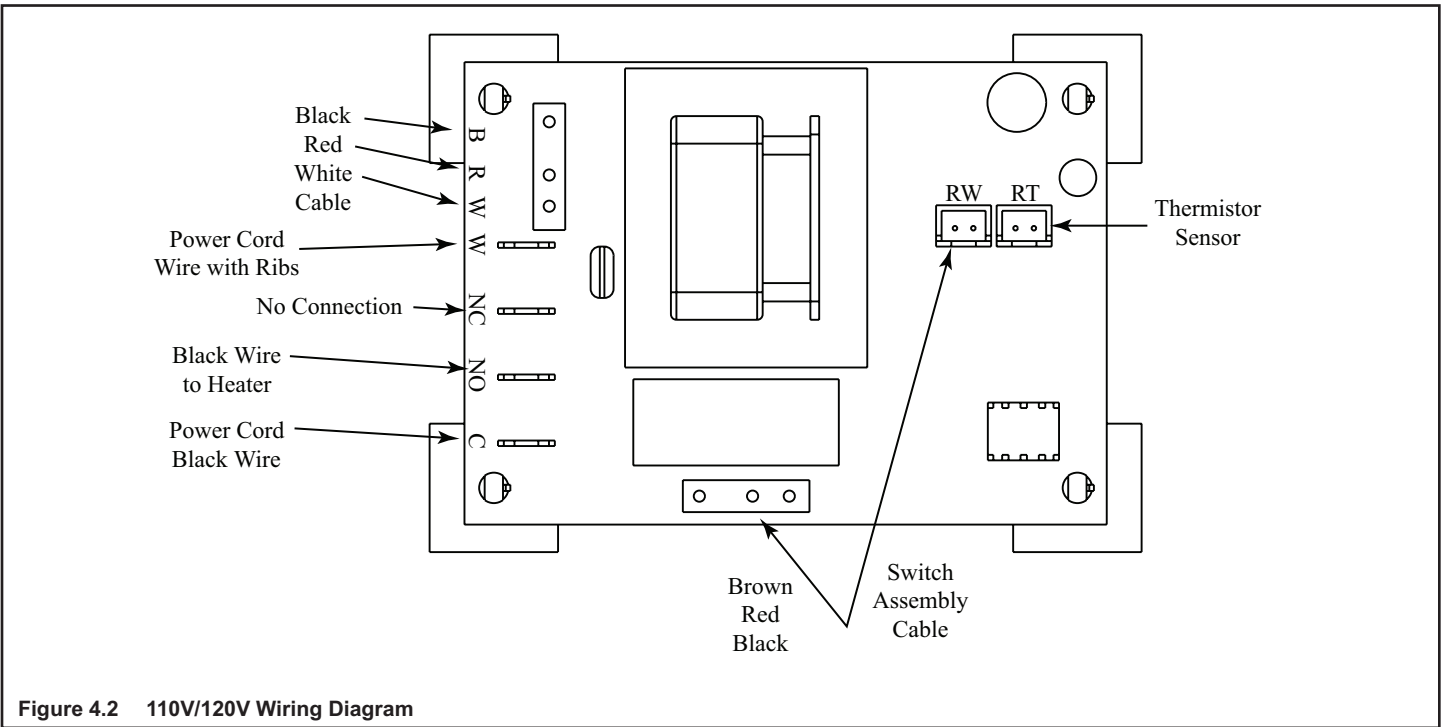

Figure 4.2 110V/120V Wiring Diagram

# 5 Accessories

---

## A. Install the Front Face

Install the front face following the instructions packaged with the face.

## B. Install other Optional Accessories

Installation of other optional accessories may be done at this time.

The heater is now ready for operation. See Section 7.



### WARNING

#### Shock Risk

Do NOT operate this heater without the front face installed.

# 6 Finishing

## A. Finishing Material

### • Combustible Material

Material which is made of or surfaced with wood, compressed paper, plant fibers, plastics, or any material capable of igniting and burning, whether flame proofed or not, plastered or not plastered.

### • Non-Combustible Material

Material which will not ignite and burn. Such materials are those consisting entirely of steel, iron, brick, tile, concrete, slate, glass or plasters, or any combination thereof.

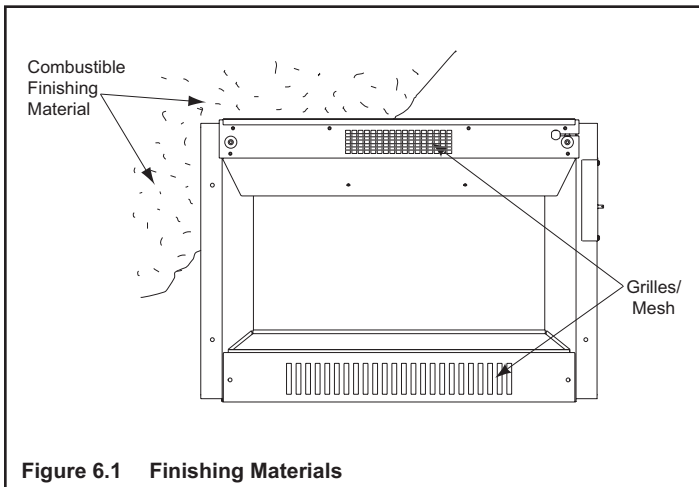

Figure 6.1 Finishing Materials

## B. Finishing Checklist

- Power supply service must be completed prior to finishing to avoid reconstruction.
- **Grilles and air openings cannot be covered in any circumstances.**

**Note:** The heater is a zero clearance fireplace and may be finished with combustible or noncombustible finishing materials.

When using paint or lacquer to finish the mantel, they must be heat-resistant to prevent discoloration.

**Note:** Finishing materials are normally installed behind the nailing flanges or up to the sides of the nailing flanges. Allow room for the front to be added and the heater to be anchored.

## C. Mantel

The height that a combustible mantel is fitted above the heater is dependent on the height of the front selected.

- The minimum height is 1 in. (25 mm) above the front.
- Fronts available for the 26 in. heater:
  - 24 in. (610 mm) high
  - 28 in. (711 mm) high
  - 32 in. (813 mm) high
- Fronts available for the 23 in. heater:
  - 21 in. (533 mm) high
  - 28 in. (711 mm) high

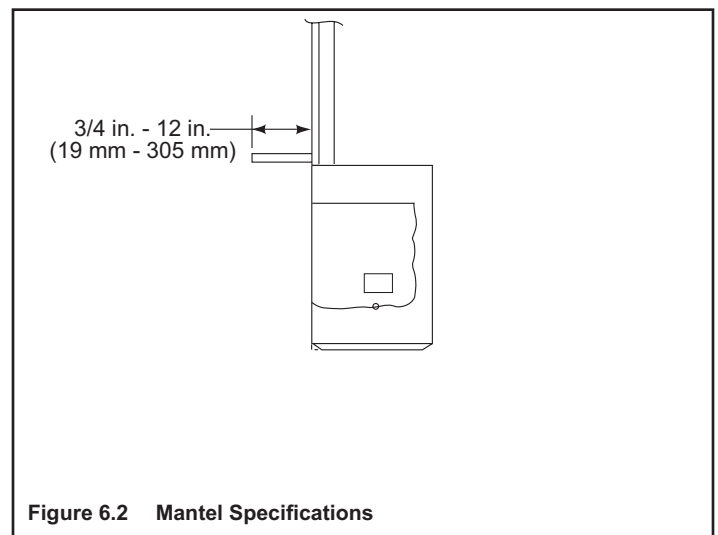

Figure 6.2 Mantel Specifications

## ⚠ WARNING



### Fire Risk

Do NOT obstruct air inlet or outlet grilles.

Do NOT modify grilles.

- Modifying or covering grilles could cause temperature rise and fire hazard.

Finishing materials must not interfere with:

- Air flow through grilles or louvers
- Operation of louvers or doors
- Access for service

# 7 Operating Instructions

**⚠ WARNING**



**Fire Risk**

- Do not operate heater before reading and understanding operating instructions. Failure to operate heater properly may cause fire.

The operating controls are located on the upper right edge of the heater.

## A. Main Power Switch

The main power switch is a three-position switch. See Figure 7.1.

- Heater "ON" - Lights bright, thermostat active.
- Heater "OFF" - All off.
- Heater "ON" - Lights dim, thermostat active
  - When the main power switch is turned "ON", it provides power to all functions.
  - When used in conjunction with the optional remote control, the switch should remain in an "ON" position.

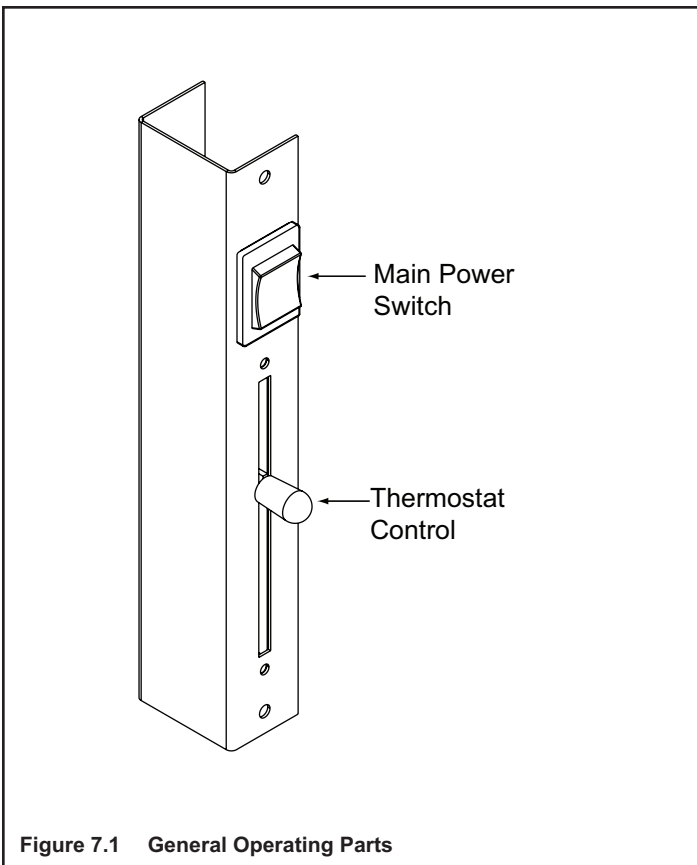

**⚠ WARNING**



**HOT! DO NOT TOUCH. SEVERE BURNS MAY RESULT. CLOTHING IGNITION MAY RESULT.**

Glass and other surfaces are hot during operation and cool down.

- Keep children away.
- CAREFULLY SUPERVISE children in same room as heater.
- Alert children and adults to hazards of high temperatures.
- Do NOT operate with protective barriers removed.
- Keep clothing, furniture, draperies and other combustibles away.

## B. Thermostat

- Active only when lights are on.
- The thermostat allows you to adjust the desired room temperature. See Figure 7.1.
  - Set at maximum - always on when the room temperature is below 104° F.
  - Set at minimum - always off when the room temperature is above 32° F.

**CAUTION**

Odors and vapors released during initial operation.

- Curing of high temperature paint.
- Open windows for air circulation.

Odors may be irritating to sensitive individuals.

**⚠ WARNING**



**Fire Risk**

All electric heaters have hot and arcing or sparking parts inside.

- Keep combustible materials, gasoline and other flammable vapors and liquids clear of heater.
- Do NOT store flammable materials close to heater.
- Keep all such liquids well away from the heater while it is in use.

Combustible materials may ignite.

# 8 Troubleshooting

## A. Troubleshooting Guide

Issues		Possible Causes		Solutions
1.	Appliance doesn't turn on with the main switch or remote transmitter.	A.	Power switch is "OFF".	Turn the power switch to the "ON" position.
		B.	Circuit breaker is tripped.	May need to put the appliance on a dedicated service or reduce the number of appliances on the circuit.
		C.	Appliance is unplugged from wall outlet.	Plug the cord into an outlet.
		D.	Loose wiring.	Check all wiring for loose connections.
2.	Appliance is on, but no flame or low flame intensity.	A.	The bulb(s) is (are) burned out.	Replace the bulb(s).
		B.	Loose wiring.	Check all wiring for loose connections.
3.	Flames are frozen.	A.	Loose wiring.	Check all wiring for loose connections.
		B.	Flame element is not attached to the motor.	Reattach the flame element to the motor.
		C.	Motor is defective.	Replace the motor.
4.	Excessive noise in the lower portion of the appliance.	A.	Flame element isn't seated properly.	Reinstall the flame element.
		B.	Motor is defective.	Replace the motor.
5.	Heating system doesn't come on.	A.	Heating system switch is "OFF".	Turn the heating system switch to the "ON" position.
		B.	Thermostat is set too low.	Turn the thermostat knob clockwise until you hear a "click".
		C.	Heating system is overheated.	The heating system is protected by a thermal cutout switch. Shut off all switches. Wait five minutes, then turn the heater on.
		D.	Loose wiring.	Check all wiring for loose connections.
6.	Fan runs but no heat is put out.	A.	Loose wiring.	Check all wiring for loose connections.
		B.	Bad heating element.	Replace the heating system.
7.	Heating element is on but fan doesn't run.	A.	Loose wiring.	Check all wiring for loose connections.
		B.	Fan is defective.	Replace the heating system.
8.	The heater doesn't turn off.	A.	Thermostat is set too high.	Slide the thermostat knob down until you hear a "click".
9.	Excessive noise in upper portion of the heater.	A.	Build up of dirt on the fans.	Clean all fans.
		B.	Heater fan is defective.	Replace the heating system.
10.	Remote control doesn't work.	A.	Remote is out of range.	Move remote closer to the heater.
		B.	Low batteries.	Replace the batteries.
11.	Odor	A.	The heater may emit a slight, harmless odor when first used. This is a normal condition caused by initial heating of the internal parts and will not occur again.	



# 9 Maintenance and Service

## A. Access the Firebox

- Turn the heater off and turn off the circuit breaker.
- Allow the heater to cool before cleaning.
- Remove the front face to access the log area.
  - Remove the screws from the switch bracket.
  - Remove by pulling out the bottom of the front and then lifting up
- Replace all parts after cleaning or bulb replacement has been completed.
- Reset the circuit breaker.

## B. Clean the Firebox Compartment

Use the brush attachment and gently vacuum the compartment.

## ➔ C. Clean the Back Acrylic Panel

- The panel is cleaned in the factory during the assembly process. During shipment, installation, handling, etc., the surface may collect dust particles. These can be removed by buffing lightly with a clean dry cloth.
- To remove fingerprints or other marks, the panel can be cleaned with a damp cloth using a mild soap and water solution. **DO NOT USE GLASS CLEANER! IT WILL DAMAGE THE BACK ACRYLIC PANEL.** The panel should be completely dried with a lint free cloth or paper towel.

## D. Replace the Light Bulbs

The light bulbs need to be replaced when the flame and/or ember bed is dark on one side. Replace the bulbs with **75 watt halogen bulbs with mini-candelabra base**. Do not exceed 75 watts per bulb. Light bulbs can be purchased at a local hardware or lighting store, on-line or by phone. We recommend you use Sylvania model SL58884 or Satco model S3157.

- Light bulb access is through the hearth assembly. See Figure 9.1.
- Locate and lift the bent tabs holding the hearth assembly located at each end of the assembly.
- Lift out the hearth assembly.
- Carefully remove the burned out bulb from the light socket. Place the new bulb in the socket. See Figure 9.2. **Follow directions on the light bulb package for handling requirements.**
- Reinstall the hearth assembly.



**⚠ WARNING**

**Shock Risk**  
**Burn Risk**

Cleaning, performing maintenance or moving this electric heater without disconnecting power and allowing the heater to cool could create a shock or burn hazard.

- Turn controls to "OFF".
- Remove plug from outlet or turn off the circuit breaker to the heater.

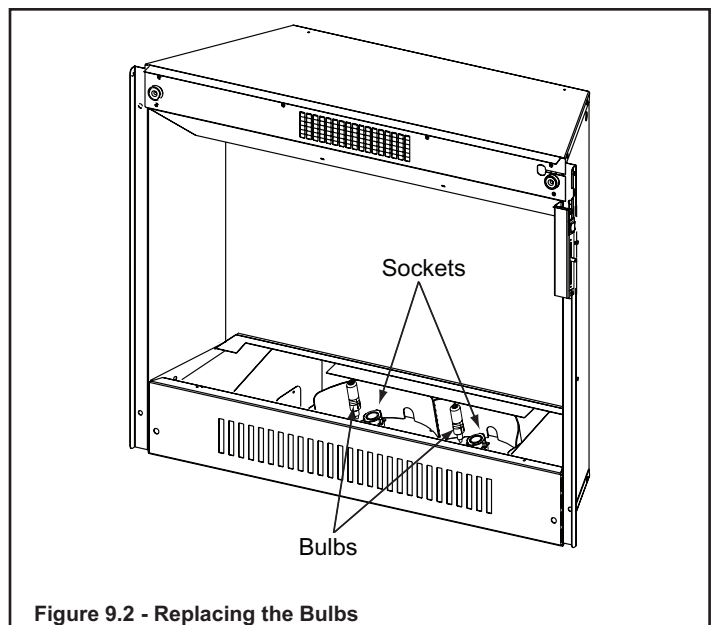
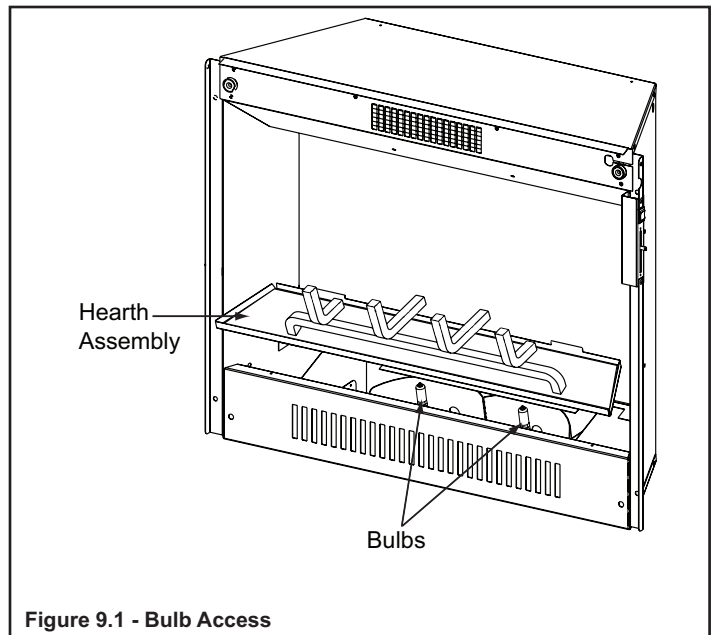

## CAUTION



Handle glass assembly with care.

**When cleaning glass door:**

- Avoid striking, scratching or slamming glass.
- Do NOT use abrasive cleaners.
- Use a hard water deposit glass cleaner on white film.
- Do NOT clean glass when it is hot.

### E. Maintenance Task List

Inspect	Maintenance Tasks
Glass Doors	1. Inspect glass panels for cracks. Replace if this condition is present.
	2. Confirm there is no damage to glass or glass frame. Replace as necessary.
	3. Clean glass using a non-abrasive cleaner such as Brasso®.
Circulation Compartment	1. Remove any foreign objects.
	2. Verify unobstructed air circulation.

# 10 Reference Materials

## A. Heater Dimensions

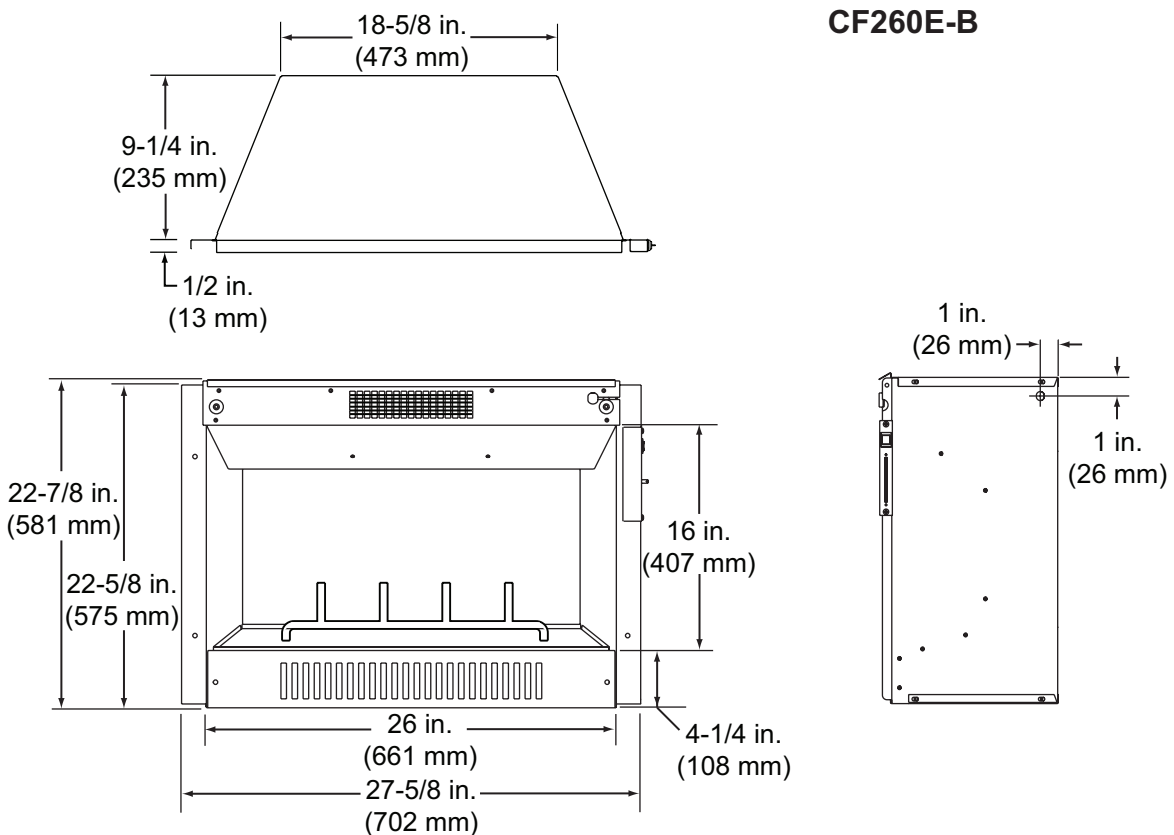
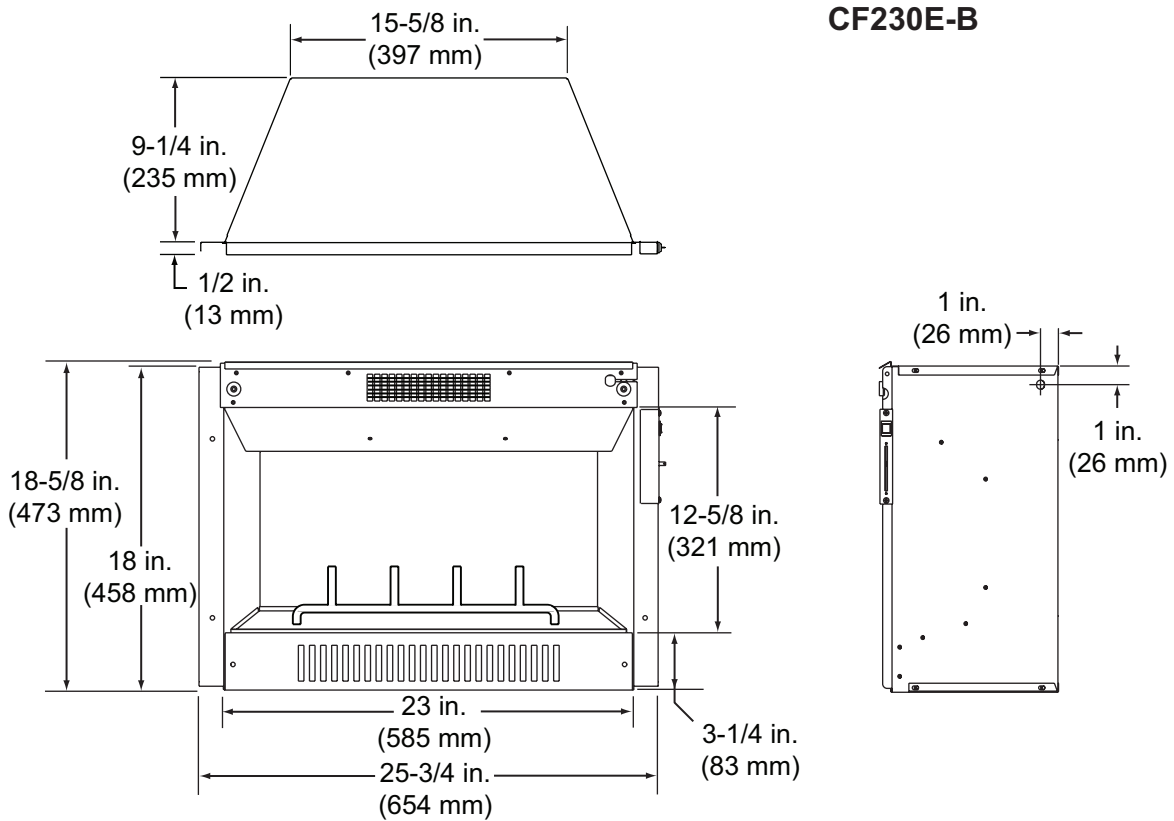

## B. Optional Components

### Remote Control

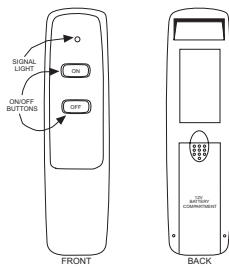

**RC-ELEC-HNG**  
**Remote Control**

### Refractory

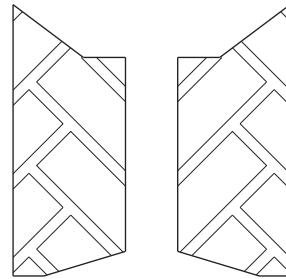

Left Right  
**RF23E (CF230E-B)**  
**RF26E (CF260E-B)**  
**Side Refractory**

### Trim Kits

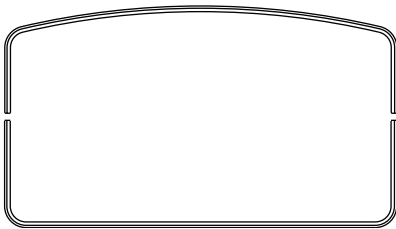

**PBT23EA (CF230E-B)**  
**PBT26EA (CF260E-B)**  
**SST23EA (CF230E-B)**  
**SST26EA (CF260E-B)**

**PBT = Polished Brass Trim**  
**SST = Stainless Steel Trim**

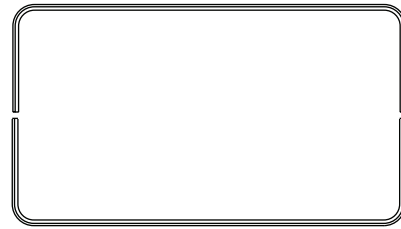

**PBT23ER (CF230E-B)**  
**PBT26ER (CF260E-B)**  
**SST23ER (CF230E-B)**  
**SST26ER (CF260E-B)**

### Cabinets

Several styles of cabinets are available for use with these heaters. See your dealer/distributor for styles and sizes.



### CF230E-B

Model	Description	Width	Height
EFHB2621	Black Front w/Mesh	26 in.	21 in.
EFHD2621	Deluxe Black Front w/Mesh	26 in.	21 in.
EFHD4021	Black Front w/Mesh	40 in.	21 in.
EFHD23-4028	Black Front w/Mesh	40 in.	28 in.

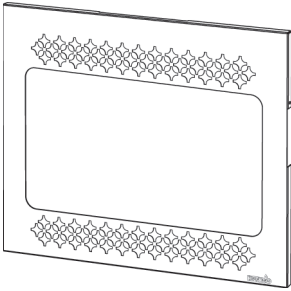

**EFHB2621**

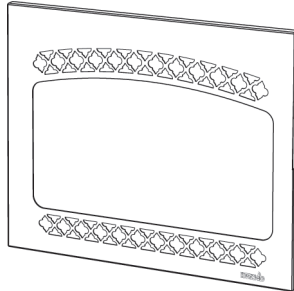

**EFHD2621**

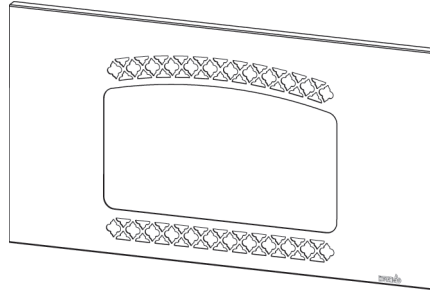

**EFHD4021**

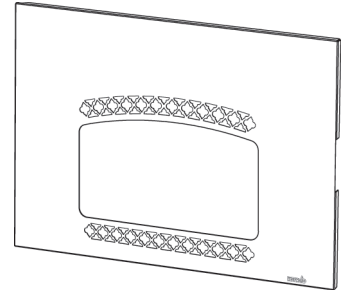

**EFHD23-4028**

### CF260E-B

Model	Description	Width	Height
EFHB2824	Black Front w/Mesh	28 in.	24 in.
EFHD2824	Deluxe Black Front w/Mesh	28 in.	24 in.
EFHD26-4028	Black Front w/Mesh	40 in.	28 in.
EFHD4432	Black Front w/Mesh	44 in.	32 in.

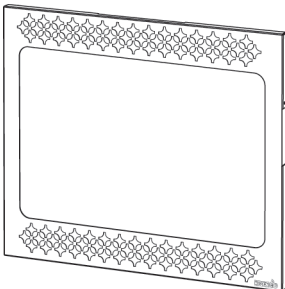

**EFHB2824**

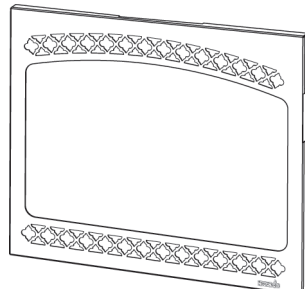

**EFHD2824**

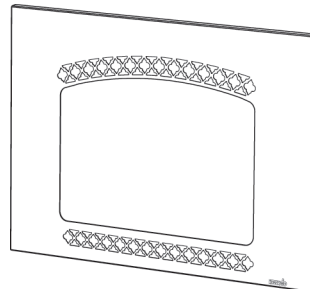

**EFHD26-4028**

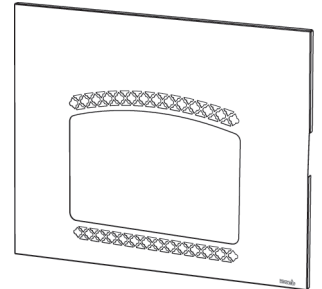

**EFHD4432**

**This page intentionally left blank.**



Where everything comes together

## WARRANTY

Hearth & Home Technologies Inc. (HHT) Electric Fireplaces are tested and inspected prior to shipment and are guaranteed from defect to the purchaser of each new product. Any part which proves to be defective in material or workmanship under normal use within one year will be repaired or replaced without charge.\* The Company will not be responsible for any expense incurred for installation, removal from service, or transportation costs. Any such defect should be brought to the attention of the Dealer where the product was purchased and is authorized to repair or replace within the terms of this warranty.

The Company's only obligation under this warranty will be at its sole option to repair or replace any part proving defective or to refund the purchase price thereof.

The owner/user assumes all other risks, if any, including the risk of any direct, indirect or consequential loss or damage arising out of the use of or inability to use the product.

The warranty will not apply if, in the sole judgement of the Company, damage or failure has resulted from accident, alteration, misuse, abuse, incorrect installation, or operation on an incorrect power source.

The foregoing is in lieu of all other warranties expressed, implied, or statutory, and the Company neither assumes, nor authorizes any person to assume for it any other obligation, or liability in connection with said product.

\*Light bulbs are not covered in the warranty.

### How to Obtain Service

To obtain service under this warranty you must:

1. Send written notice of the claimed condition to Heat & Glo Technical Service Department, Hearth & Home Technologies Inc., 800 W. Jefferson, Lake City, MN 55041.
2. Provide proof of purchase, model number, serial number, and manufacturing date code to HHT.
3. Provide HHT reasonable opportunity to investigate the claim, including reasonable opportunity to inspect the Appliance prior to any repair or replacement work and before the Appliance or any component of the Appliance has been removed from the place of original installation.
4. Obtain HHT's consent to any warranty work before the work is done.

ADDITIONAL INFORMATION: If you would like information on current Heat & Glo products or want to locate a dealer in your area, call 1-888-427-3973.

©2003 Heat & Glo® is a Registered Trademark of Hearth & Home Technologies Inc.

