

Models:
GFK21B
Fan Kit



If you need clarification of any of the instructions contained here contact your dealer or the Technical Services Department at 1-800-927-6841.

The Fan Kit has been designed to circulate room air through the appliance to enhance heat output. The fan kit operates on 120VAC, 60 Hz power. This is available through a receptacle in the factory installed junction box. The junction box is located in the controls compartment of the appliance.

A control module is provided with the fan kit which automatically turns the fan on and off at preset times and is equipped with a variable speed control to provide a quiet forced air flow at the desired speeds.

Check Contents of Shipping Carton

Compare contents of carton in Table 1 with the actual parts received. If any parts are missing or damaged, contact your dealer before starting installation. Do not install a damaged fan kit.

Installation Precautions

The Fan Kit is tested and safe when installed in accordance with this installation manual. It is your responsibility to read all instructions before starting installation and to follow these instructions carefully during installation to assure maximum benefit from, and safe operation of the fan.





WARNING

Shock Risk
Explosion Risk

Do NOT wire 110-120 VAC to gas control valve.

Do NOT wire 110/120 VAC to wall switch

- Incorrect wiring will damage millivolt values.
- Incorrect wiring will override IPI safety lockout and may cause explosion.





WARNING

Shock Risk
Fire Risk

Use ONLY optional accessories approved for this appliance.

- Using non-listed accessories voids warranty.
- Using non-listed accessories may result in a safety hazard.
- Only Hearth & Home Technologies approved accessories may be used safely.

Note: This appliance must be electrically wired and grounded in accordance with local codes or, in the absence of local codes, with **National Electric Code ANSI/NFPA 70-latest edition** or the **Canadian Electric Code CSA C22.1**.



CAUTION



Sharp Edges

- Wear protective gloves and safety glasses during installation.

Description	Part Number	Qty.
Fan	19263A	1
Fan Bracket	4016-099	1
Electrical Cord	26648	1
Control Module	4021-708	1
Air Deflector	22520	1
Fastener Pack	4025-019	1
Magnetic Tape	4021-654	2
Screws		6
Foam Tape	4021-655	2
Wire Assembly	2005-863	1
Jumper Wire (blue)		1

Table 1 Contents of Carton

Note: An arrow (➔) found in the text signifies change in content.

Note: You may not need all parts included with this kit.

1. Install the Fan Bracket & Shield

- Place the fan bracket around the fan. See Figure 1.

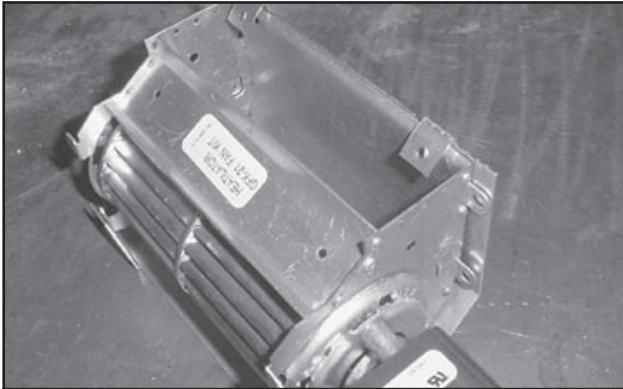

Figure 1 Fan Bracket-No screws

- If no fan shield is needed, install screws to hold the front of the fan bracket in place. See Figure 4.

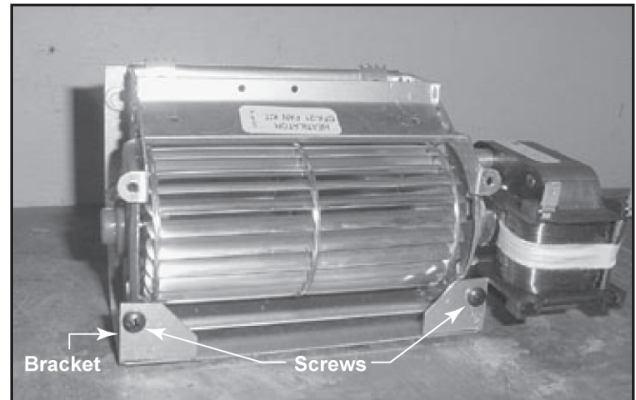

Figure 4 Fan Bracket

- Use pliers to crimp the bracket tabs around the fan housing. See Figure 2.

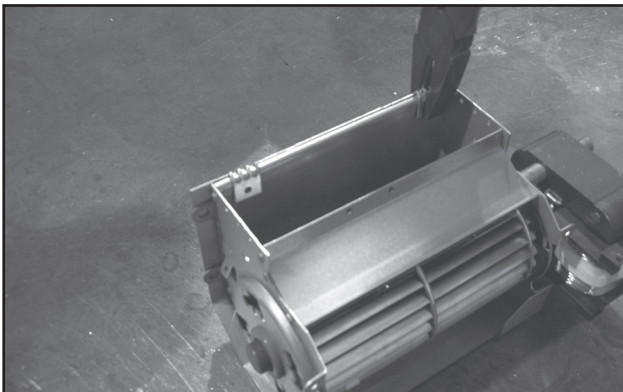

Figure 2 Crimp Bracket Tabs

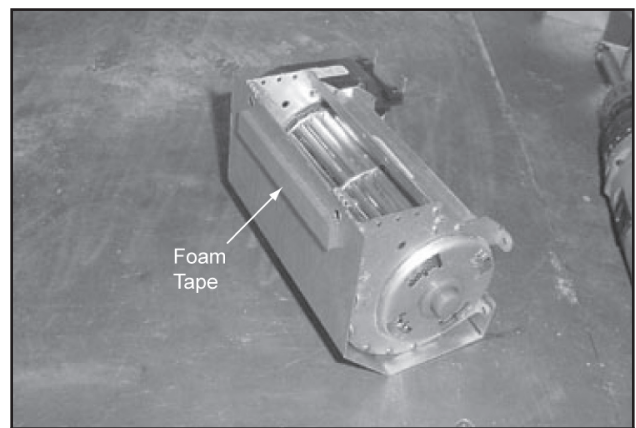

Figure 5 Foam Tape

- If the fan is being installed in a B-vent appliance, the fan shield supplied with the appliance will also need to be attached. See Figure 3.

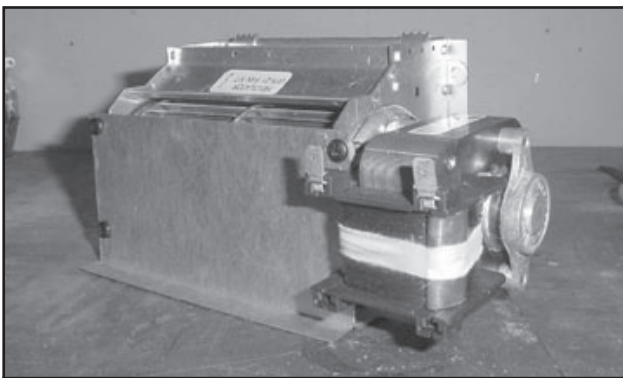

Figure 3 Fan Shield

- Attach the foam tape (Figure 5) and magnets (Figure 6) to the fan. Cut one magnet strip in half and save the remaining strip for control module.

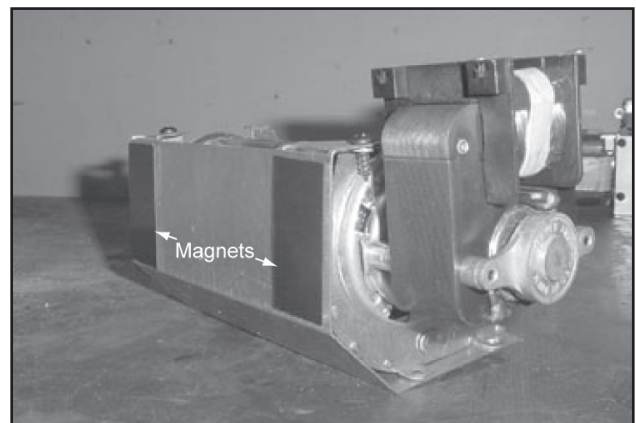

Figure 6 Magnets

2. Remove Valve Assembly

On a Novus 30 in. appliance (GNDC30 or GNBC30 only) the valve assembly must be raised slightly to allow the fan to be moved past it to the back of the appliance.

3. Install the Fan

Position the fan all the way to the rear and center in the appliance. Press the fan (magnets to the bottom) to the back of the appliance. See Figure 7. Plug the fan cord into the fan receptacle labeled "FAN" on the junction box. See Figure 8.

4. Install the Control Module

Attach the control module to the bottom pan using the magnetic tape provided.

5. Wiring the Fan Control Module

Note: Fan control timer only for use on units with junction box pictured in Figure 9.

- Robertshaw Valve (Standing Pilot)
 - Connect the black, white and red wires with 1/4 in. female connectors from the fan control module to the appliance junction box as shown in Figure 9.
 - Connect the black ground wire with the ring terminal to the TP screw on the valve (center).
 - Remove wall switch wire connected to valve terminal marked "TH".
 - Connect the black with white stripe wire with 3/16 in. piggyback connector from fan control module to valve terminal marked "TH".
 - Connect wall switch wire removed from valve terminal "TH" to the piggyback connector on the black with white stripe fan control module wire.

Note: Thermopile must be wired as shown in Figure 9.

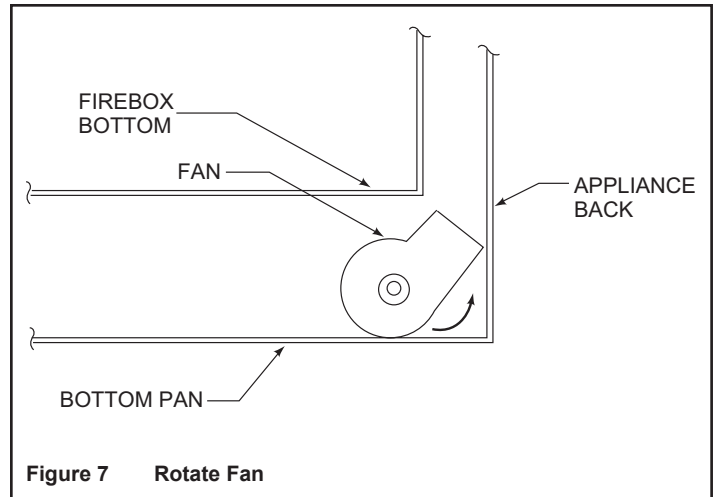

Figure 7 Rotate Fan

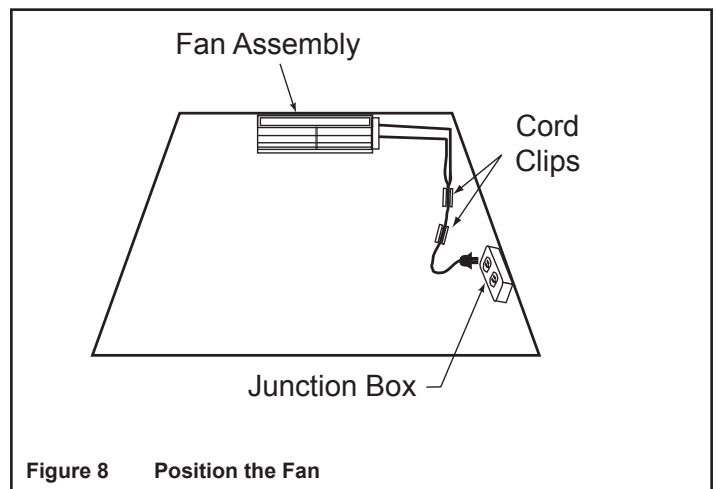

Figure 8 Position the Fan

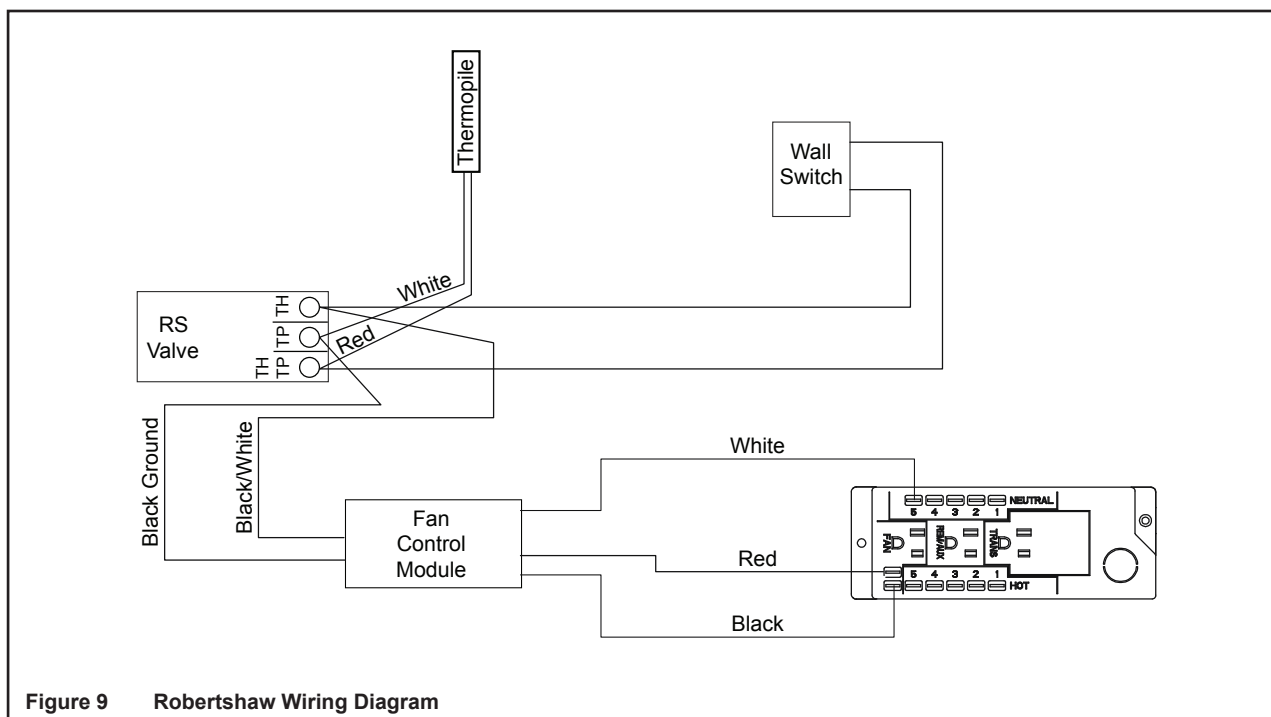

Figure 9 Robertshaw Wiring Diagram

- Dexen Valve (IPI) * (wiring diagram when using junction box with spade connectors)
 - Connect the black, white and red wires with 1/4 in. female connectors from fan control module to appliance junction box as shown in Figure 10.
 - Connect the black ground wire from the fan control module to the appliance.
 - Remove the green ignition control wire from the valve.
 - Connect the black with white stripe wire with 3/16 in. piggyback connector from fan control module to valve.
 - Connect green ignition control wire to piggyback connector on black with white stripe fan control module wire.

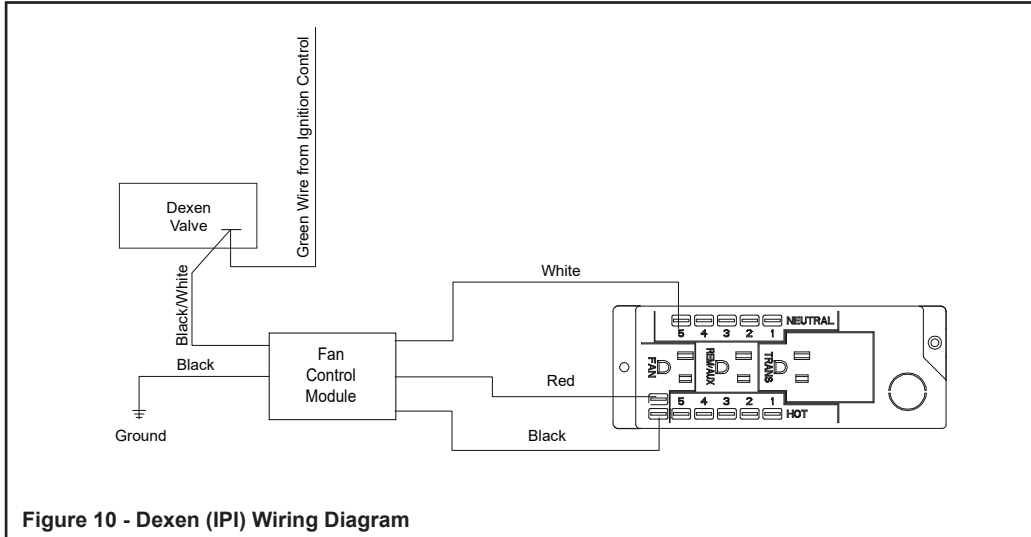

Figure 10 - Dexen (IPI) Wiring Diagram

* INCLUDES INTELLIFIRE-PLUS WHEN USING RC100. FAN TIMER NOT USED WITH RC200 OR RC300.

- Dexen Valve (IPI) * (wiring diagram when using junction box without spade connectors)
 - Connect the black, white and red wires with 1/4 in. female connectors from fan control module to wire assembly as shown in Figure 11.
 - Connect the black ground wire from the fan control module to the appliance.
 - Remove the green ignition control wire from the valve.
 - Connect the black with white stripe wire with 3/16 in. piggyback connector from fan control module to valve.
 - Connect green ignition control wire to piggyback connector on black with white stripe fan control module wire.
 - Plug receptacle from wire assembly into junction box.

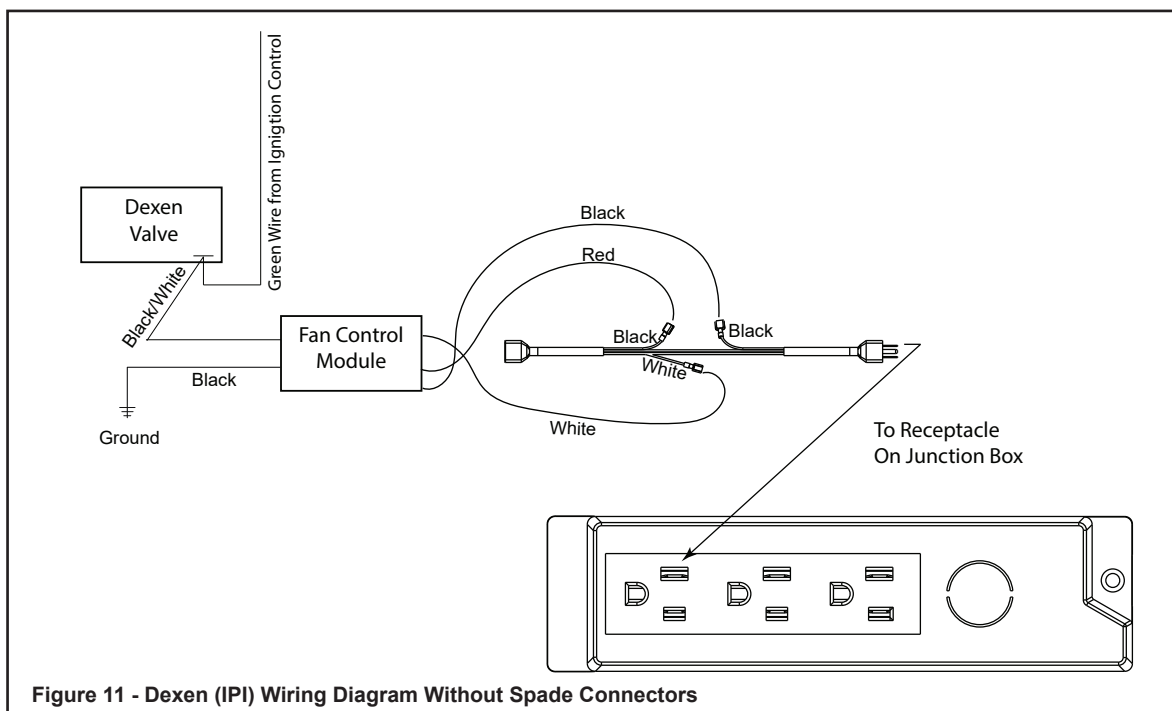
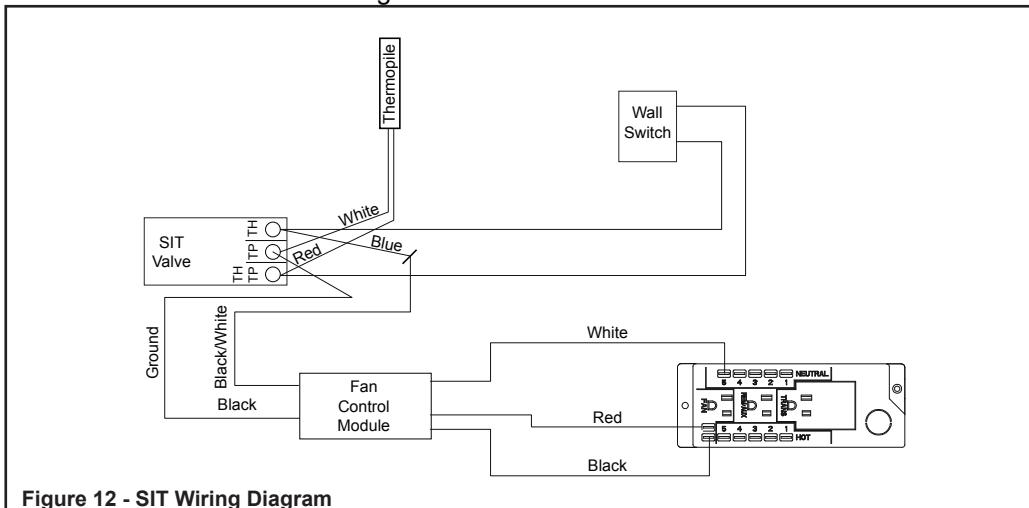

Figure 11 - Dexen (IPI) Wiring Diagram Without Spade Connectors

- **SIT Valve**

- Connect the black, white and red wires with 1/4 in. female connectors from fan control module to appliance junction box as shown in Figure 12.
- Connect the black ground wire with the ring terminal to the TP screw on the valve (center).
- Connect blue jumper wire between fan control wire (black with white stripe) and valve. Plug 1/4 in. female end of blue jumper wire to the back side of valve wiring block marked TH.



6. Recommended Fan Control Set-up Procedure

Note: The test sequence works only during the first (approximately) seven minutes after power-up.

- With burner and pilot extinguished:
- Turn control knob clockwise to activate control.
- Press and hold test button on the control module.
 - Fan will turn on.
 - Adjust fan speed to the desired speed using the control knob.
 - Release test button. Fan will stop.
- Fan control is now fully operational and will operate automatically each time appliance is used.
- Operates with APPROXIMATELY a 7-minute delay to turn on and a 12-minute delay to turn off.