

NOTES:

- 1 NO COMBUSTIBLE MATERIAL WITHIN 6" OF THE TOP OF THE FIREPLACE. COMBUSTIBLE MATERIAL SHALL NOT BE PLACED DIRECTLY ON THE FACE OF THE FIREPLACE, TOP.
- 2 NO COMBUSTIBLE MATERIAL WITHIN 1" OF THE SIDES AND BACK OF THE FIREPLACE. COMBUSTIBLE MATERIAL SHALL NOT BE PLACED DIRECTLY ON THE FACE OF THE FIREPLACE, BACK AND SIDES.
- 3 1" CLEARANCE TO B-VENT MUST BE MAINTAINED.
- 4 GAS LINE PRESSURE: 140,000 BTU MEASURED AT 7.0"/11.0" W.C. REQUIRED. **NG/LP**
POWER REQUIREMENT: 120 VAC, 5 AMP MAX DRAW.
- 5 STEEL 3" SURFACE MAY BE LEFT EXPOSED OR COVERED WITH COMBUSTIBLE FINISHING MATERIAL. FASTENERS SHALL NOT PENETRATE THE 3" SURFACE.
- 6 COMBUSTIBLE MATERIAL SHALL NOT BE APPLIED TO THIS SURFACE SHOWN ABOVE THE 3" DIMENSION. NON-COMBUSTIBLE MATERIAL MAY BE APPLIED TO SURFACE SHOWN PRIOR TO FINISHING MATERIAL. IF FINISHING MATERIAL REQUIRES A STRUCTURAL BACKER.
- 7 THE 1/2" CLEARANCE TO COMBUSTIBLES MUST BE MAINTAINED ON THIS SURFACE. IF THE 1/2" STAND OFFS ARE REMOVED, ONLY NON-COMBUSTIBLE MATERIAL SHALL BE INSTALLED AGAINST THIS SURFACE. 1/2" INCH STAND OFFS ARE INCLUDED ON FACE OF FIREPLACE.
- 8 IF STRUCTURAL BACKER IS REQUIRED FOR FINISHING MATERIAL, COMBUSTIBLE MATERIAL IS ALLOWED IN THE AREA SHOWN BELOW THE 3" DIMENSION.
- 9 **DIMENSION SHOWN IS ALLOWABLE FINISHING DIMENSION. THIS IS THE OPENING SIZE REQUIRED TO FIT THE GLASS PANELS INTO THE FIREPLACE. FINISHING MATERIAL SHALL NOT OVERLAP DIMENSION SHOWN.**
- 10 FLAT COVERS WILL COVER THE COMPONENT ACCESS AREA. GAS AND ELECTRICAL INLETS ARE LOCATED BEHIND THESE PANELS. THESE ARE USED FOR MANUFACTURING PURPOSES AND MAY BE USED AFTER FIREPLACE INSTALLATION TO ACCESS COMPONENTS DURING SERVICE. THERE SHALL BE ACCESS FROM THE INSIDE OF THE FIREPLACE AS WELL.
- 11 GLASS SHALL NOT BE DIVIDED INTO SECTIONS. GLASS SHALL BE SAFE T TOUCH SYSTEM THAT COMPLIES WITH ANSI STANDARD Z 21.50, MAX TEMPERATURE 172°F.
- 12 FIREPLACE OPTIONS:
FIREPLACE SHALL HAVE LINEAR FLAME DOWN THE LONG AXIS, RIBBON BURNER.
FIREPLACE SHALL HAVE MEDIA BED LIGHTING.
- 13 HOOD SHALL BE SUPPORTED AT APPROXIMATE LOCATIONS SHOWN USING .250-20 UNC THREADED ROD. TEMPORARY SUPPORTS SHALL BE PROVIDED FOR INSTALLATION.
- 14 INTAKE COLLAR CAN BE ROTATED TO VENT OFF THE SIDE, OR FROM THE BOTTOM OF THE FIREPLACE.

HEIGHT OPTIONS PER MODEL			
MODEL NUMBER	DIM "A"	DIM "B"	DIM "C"
8-BY-20-G	20"	40"	52"
8-BY-24-G	24"	44"	56"
8-BY-30-G	30"	50"	62"
8-BY-36-G	36"	56"	68"
8-BY-48-G	48"	68"	80"
8-BY-60-G	60"	80"	92"

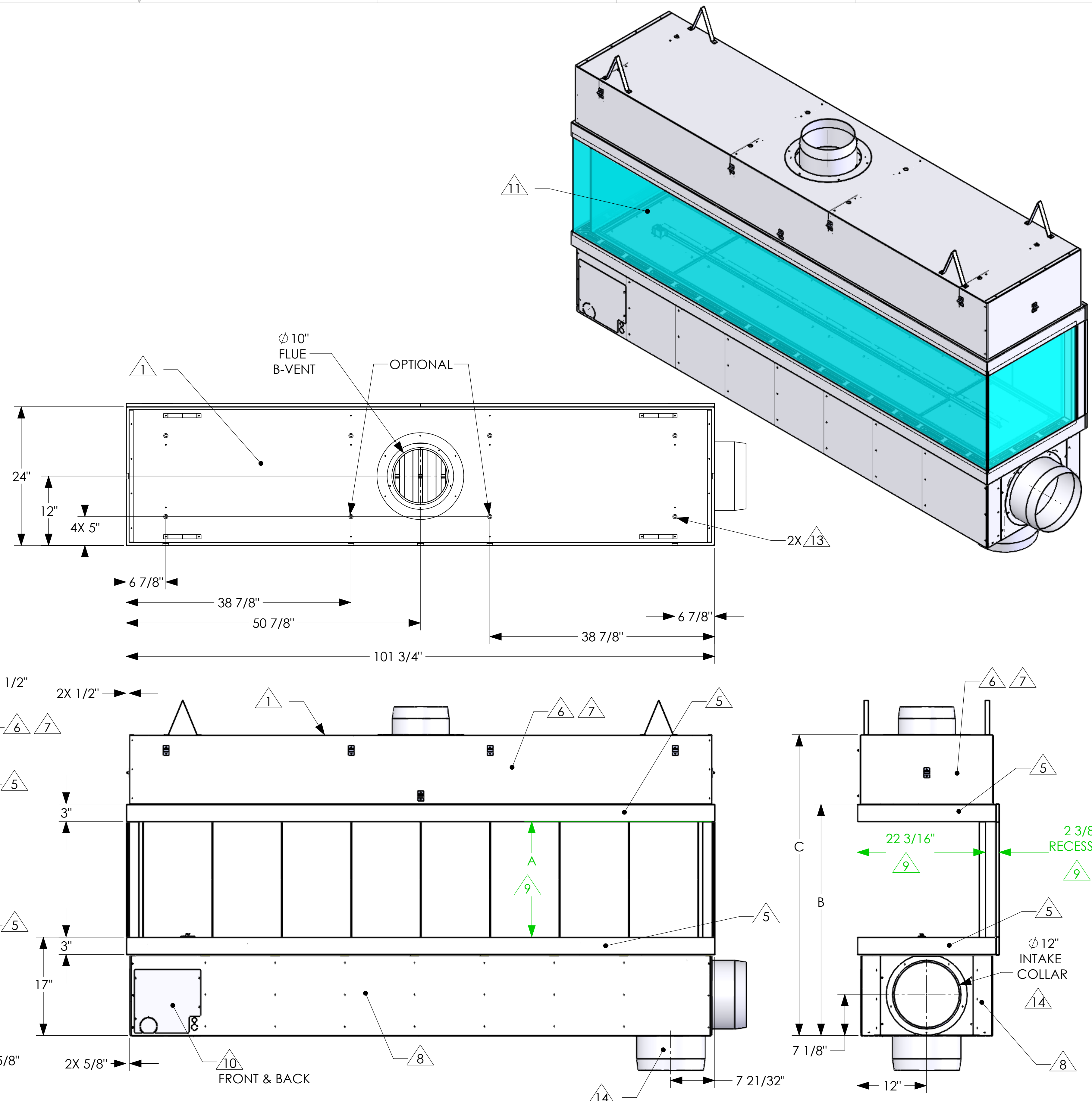

UNLESS OTHERWISE SPECIFIED DIMENSIONS ARE IN INCHES: TOLERANCE - (1) PLACE DEC: ±0.1 (2) PLACE DEC: ±0.06 (3) PLACE DEC: ±0.031 ANGLE: ±2° FRACTION ±1/16
 ← OUTSIDE MATERIAL. ○ EDGE OR INSIDE MATERIAL. ↖ OUTSIDE APEX. • INSIDE APEX. - DIMS ENCLOSED BY AN OVAL ARE CRITICAL DIMENSIONS

REV	REVISIONS	DATE	DRFT	ENG
2	CHANGED MODEL #, ADDED PAGE 3	9-6-23	SS	RB
1	PRELIMINARY RELEASE	1-18-22	ML	RB



MODEL DESCRIPTION: 8' BAY		DATE: 1-18-22	SERIES NAME: ENLIGHT
DRAWN BY: M.LEET	SCALE: N/A	SHEET: SHEET 1 OF 1	STYLE: 8-BY-SERIES
ENGINEER: R.BERG			REV: 2

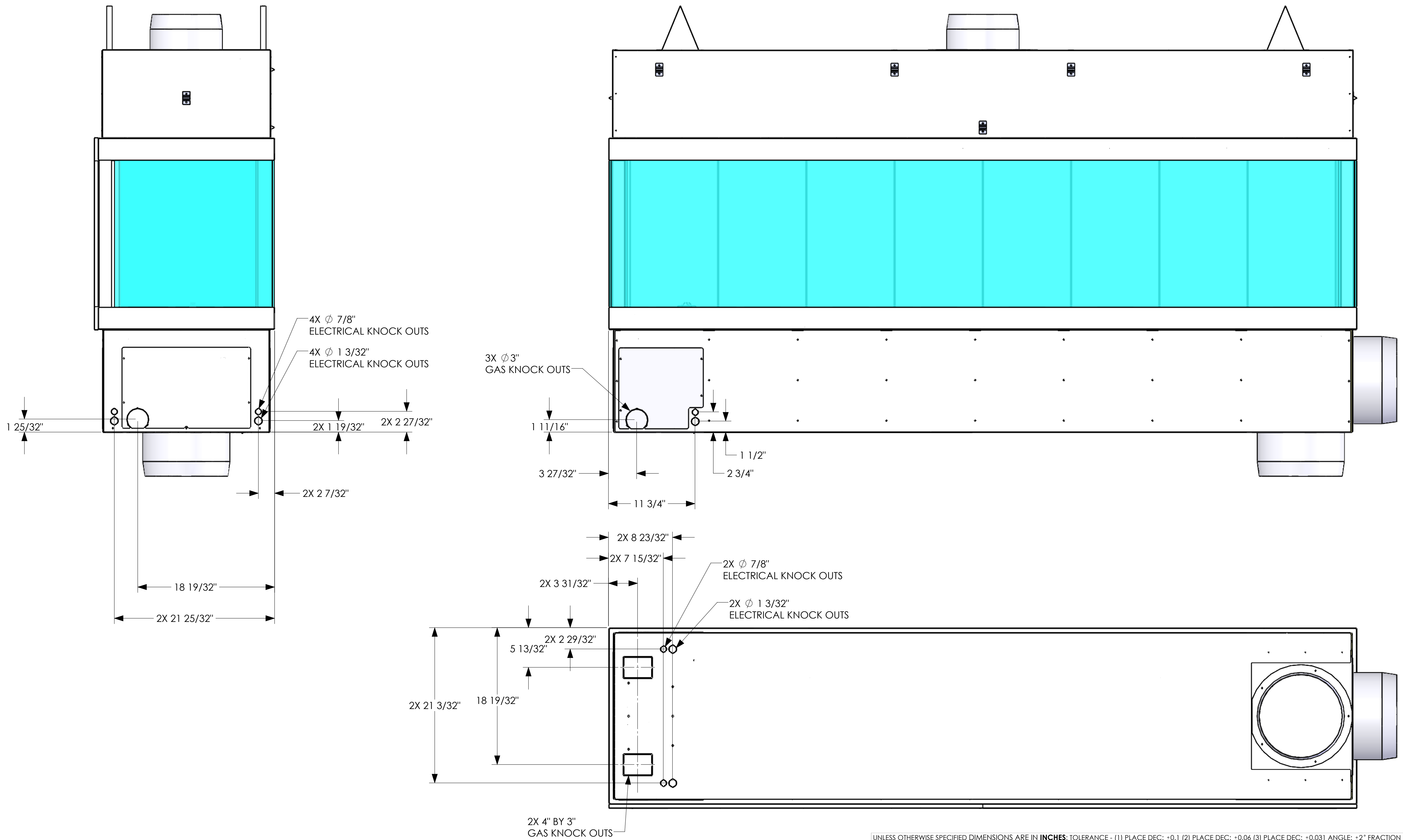

UNLESS OTHERWISE SPECIFIED DIMENSIONS ARE IN INCHES: TOLERANCE - (1) PLACE DEC: ± 0.1 (2) PLACE DEC: ± 0.06 (3) PLACE DEC: ± 0.031 ANGLE: $\pm 2^\circ$ FRACTION $\pm 1/16$
 ◀ OUTSIDE MATERIAL. ○ EDGE OR INSIDE MATERIAL. ◁ OUTSIDE APEX. • INSIDE APEX. - DIMS ENCLOSED BY AN OVAL ARE CRITICAL DIMENSIONS



DRAWING AND DESIGN IS PROPERTY OF HEARTH & HOME TECHNOLOGIES

MODEL DESCRIPTION: 8' BAY		DATE: 1-18-22	SERIES NAME: ENLIGHT
DRAWN BY: M.LEET	SCALE: N/A	ENGINEER: R.BERG	REV: 2
SHEET: SHEET 2 OF 1		STYLE: 8-BY-SERIES	

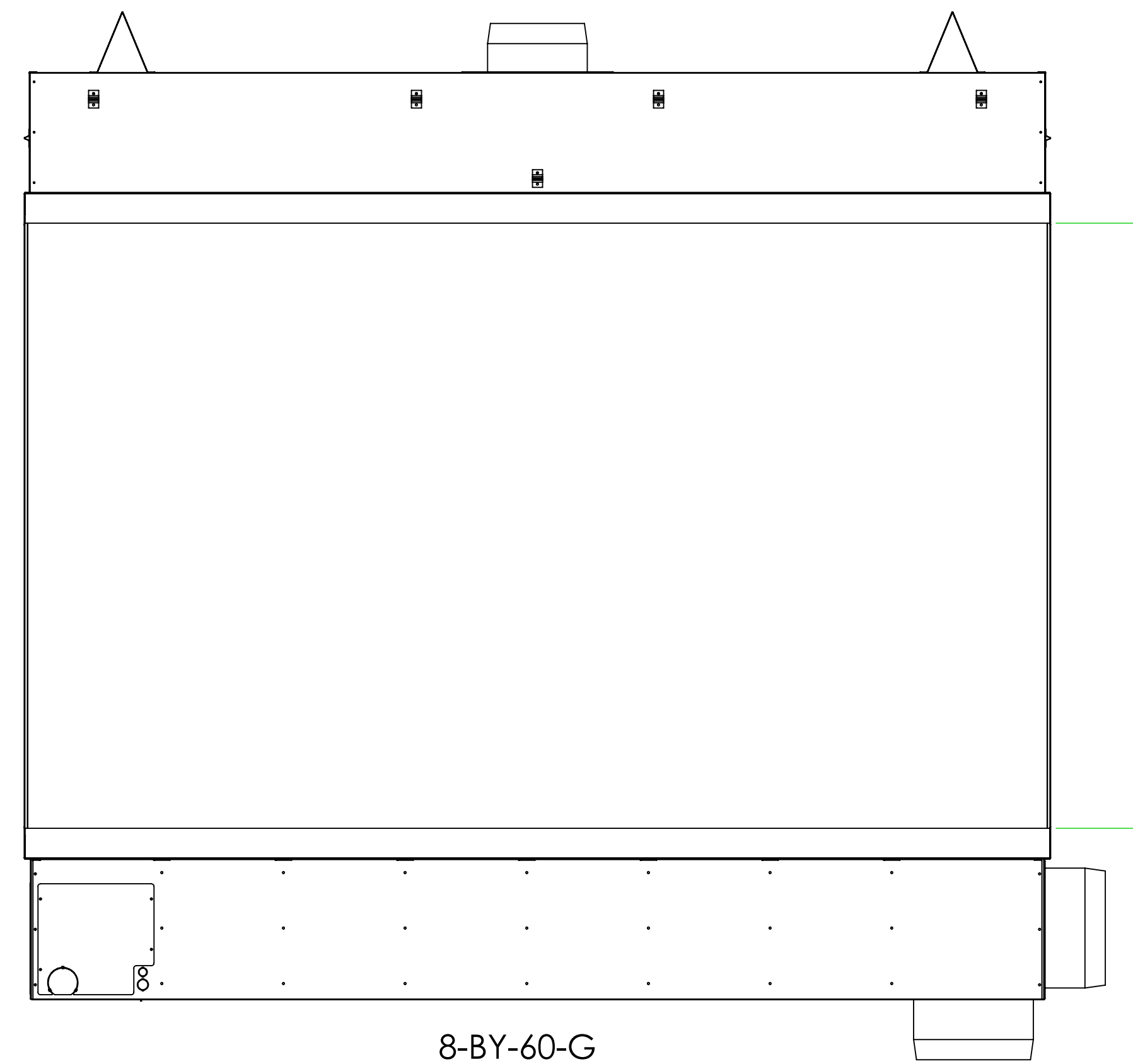
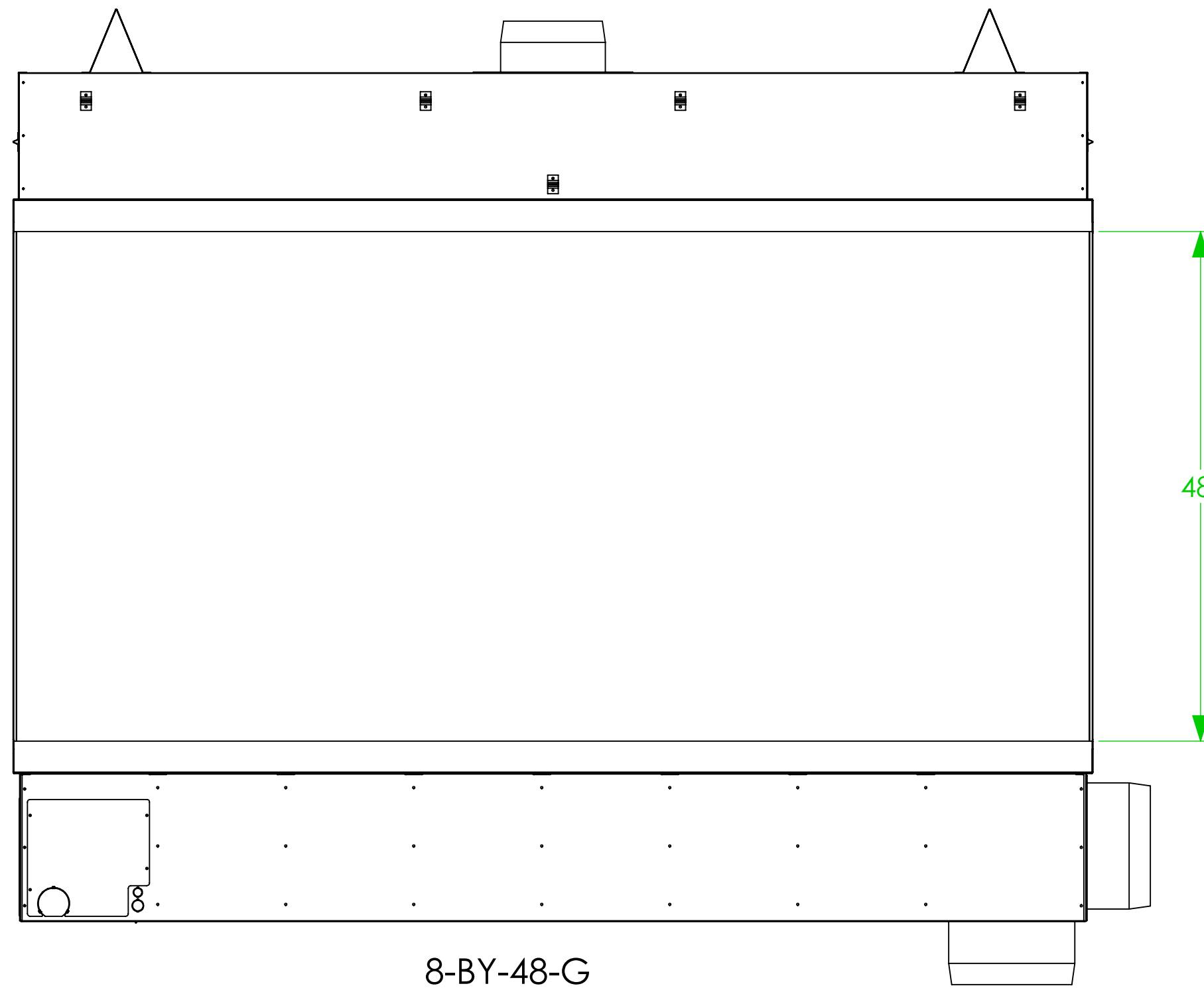
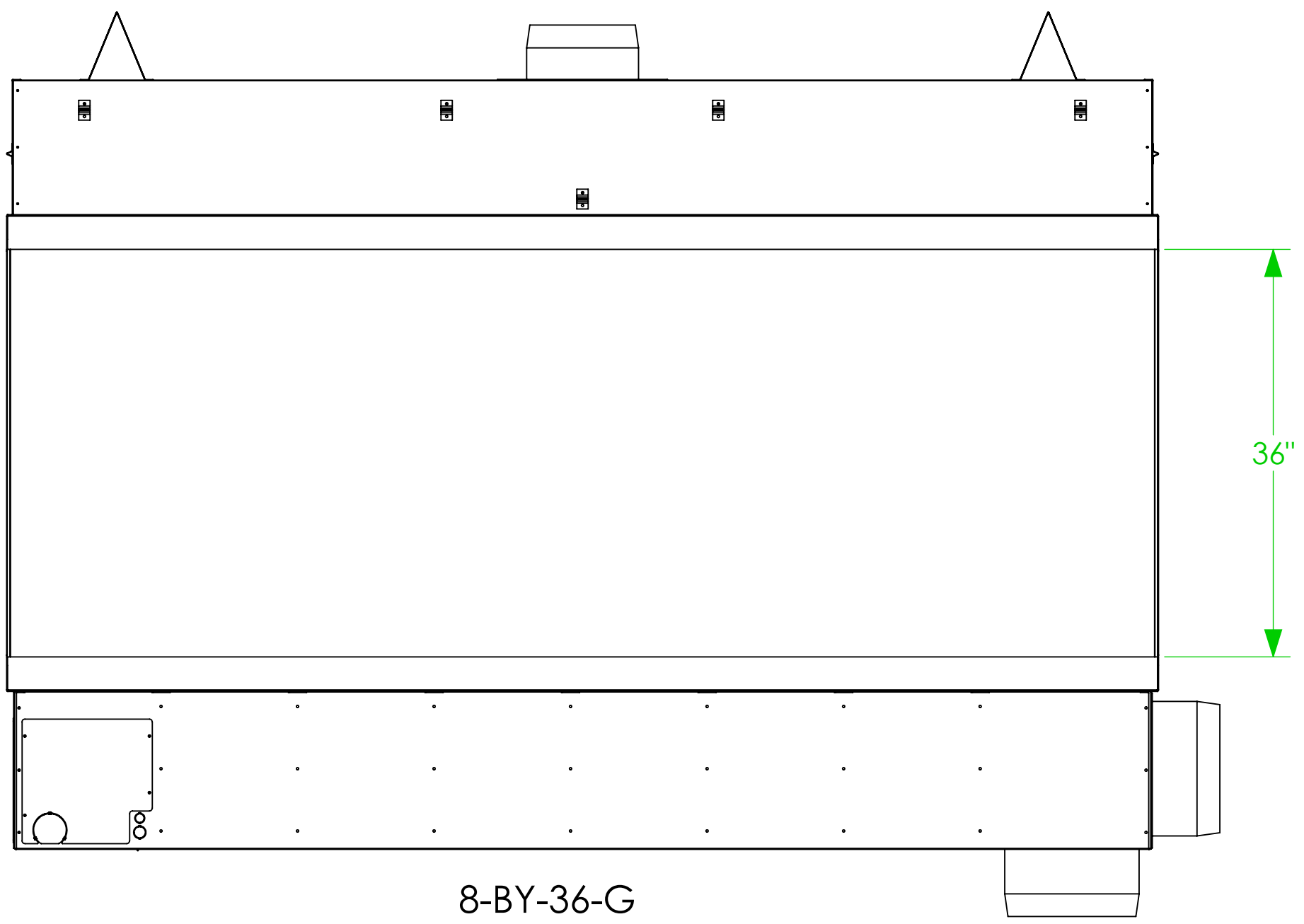
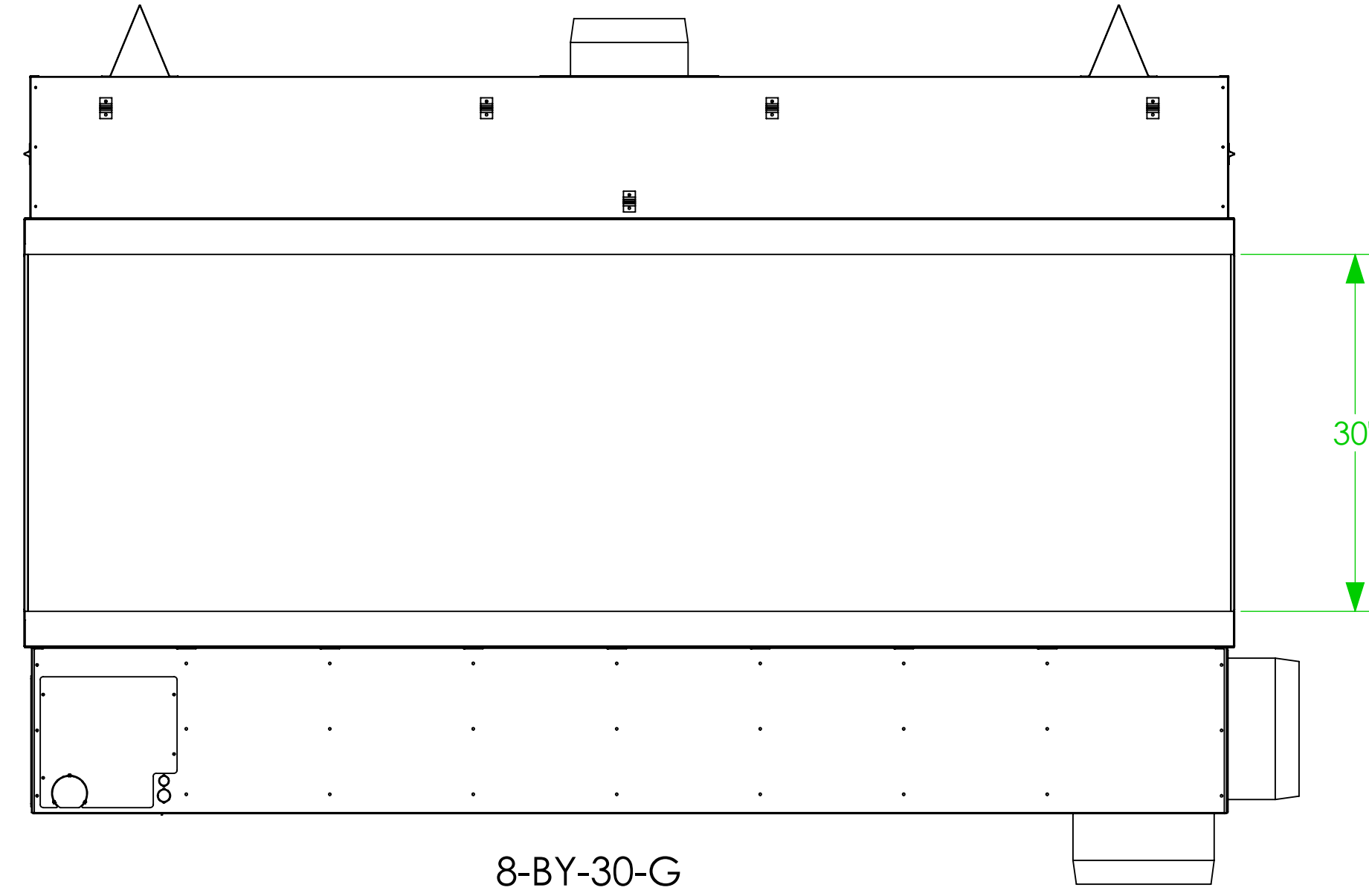
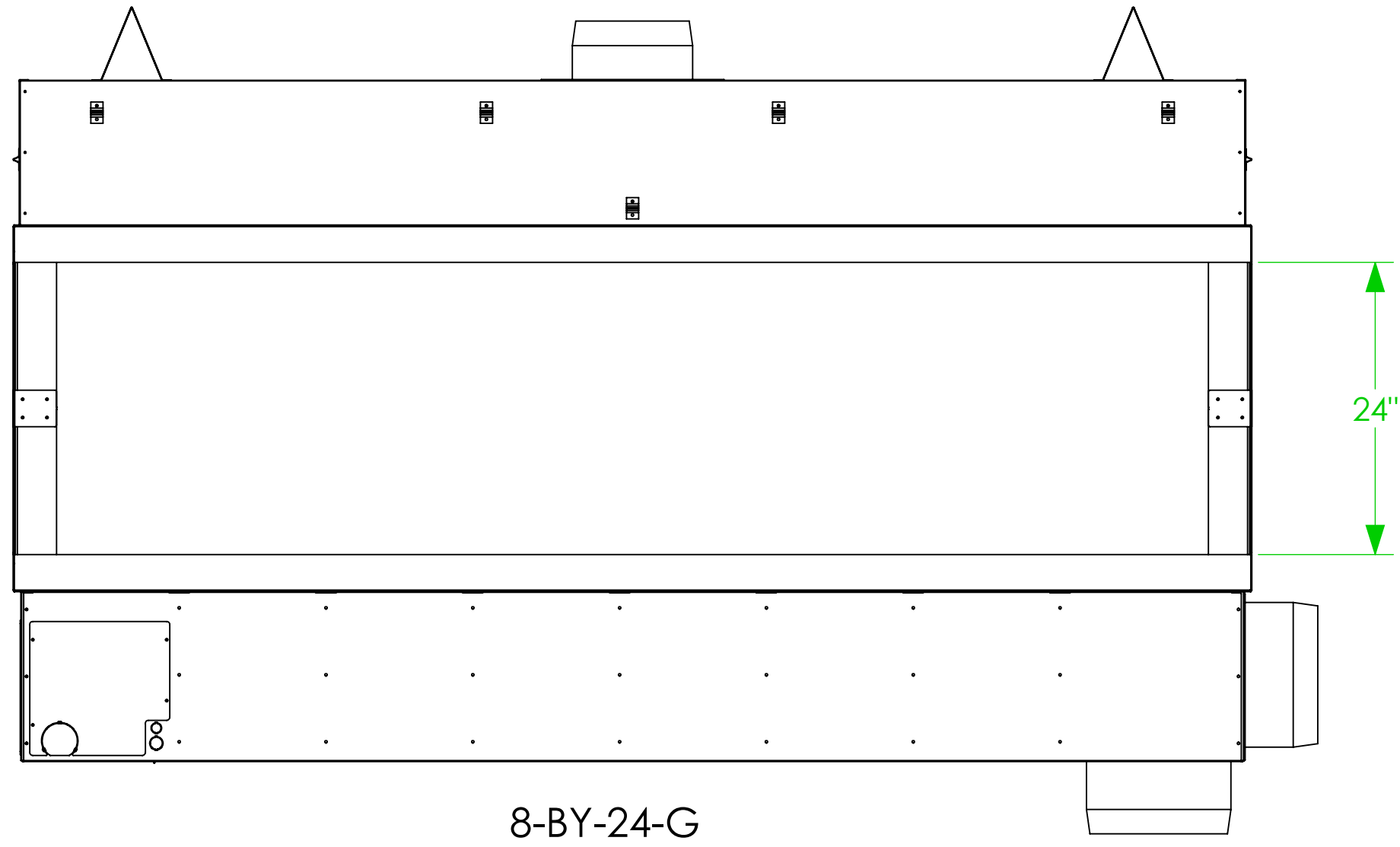
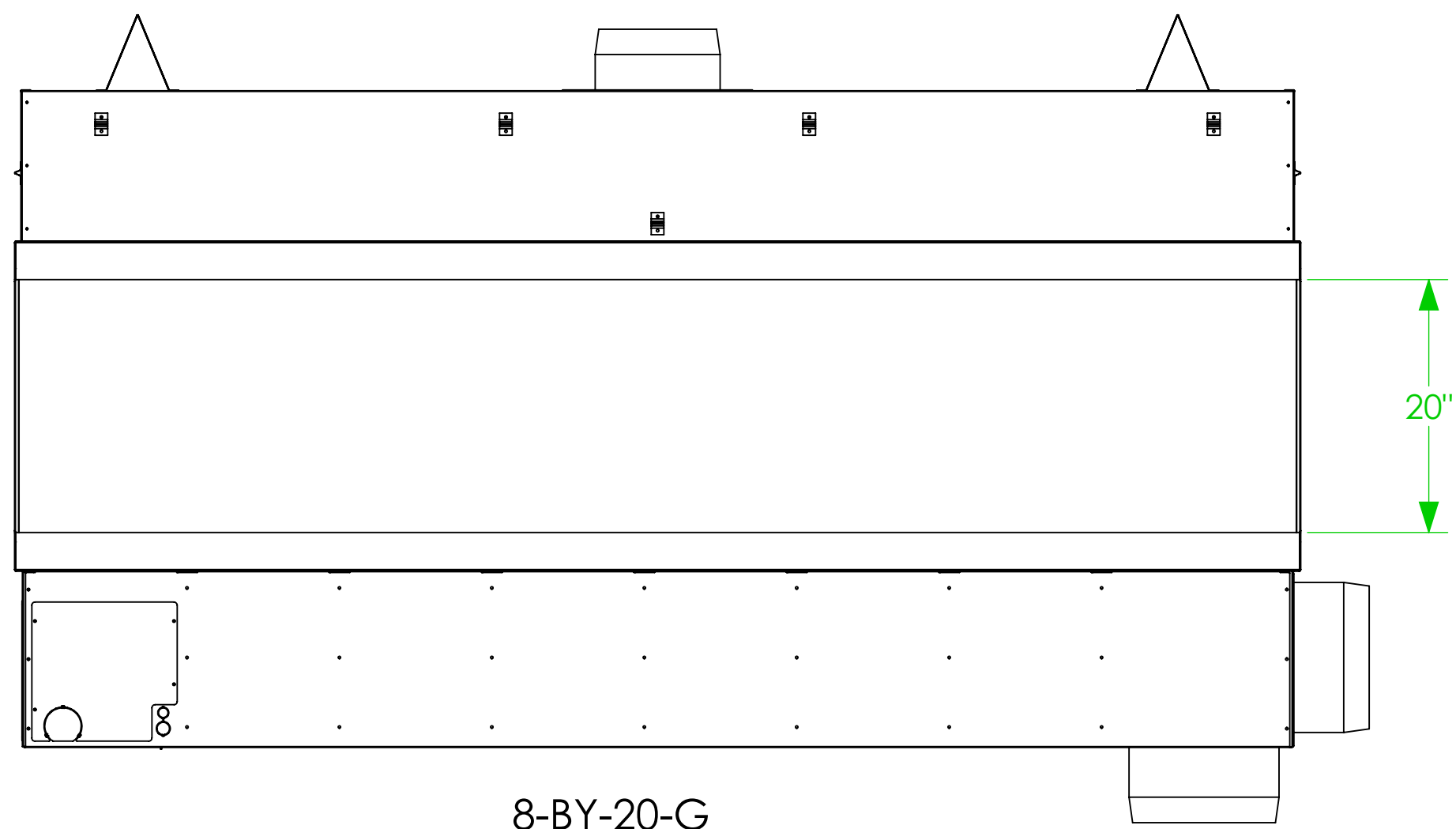

UNLESS OTHERWISE SPECIFIED DIMENSIONS ARE IN INCHES: TOLERANCE - (1) PLACE DEC: ±0.1 (2) PLACE DEC: ±0.06 (3) PLACE DEC: ±0.031 ANGLE: ±2° FRACTION ±1/16
 ◀ OUTSIDE MATERIAL. ○ EDGE OR INSIDE MATERIAL. ◁ OUTSIDE APEX. • INSIDE APEX. - DIMS ENCLOSED BY AN OVAL ARE CRITICAL DIMENSIONS



DRAWING AND DESIGN IS PROPERTY OF HEARTH & HOME TECHNOLOGIES

PART NAME: 8 X 20 BAY		DATE: 1-13-22	MATERIAL:
DRAWN BY: W. KUECHENMEISTER	SCALE: N/A	SHEET: SHEET 3 OF 1	PART NUMBER: 8-BY-SERIES
ENGINEER: R.BERG			REV: 1