

MAJESTIC

42" Reveal

B-Vent Gas Fireplace

Scan QR code for installation manual for final dimensions and requirements.



MODEL	FRONT WIDTH		BACK WIDTH		HEIGHT		DEPTH		FIREPLACE OPENING
	Actual	Framing	Actual	Framing	Actual	Framing	Actual	Framing	
RBV4842IT-B	41	42	23-3/4	42	39-1/2	39-3/4	21-1/2	22	36 x 21

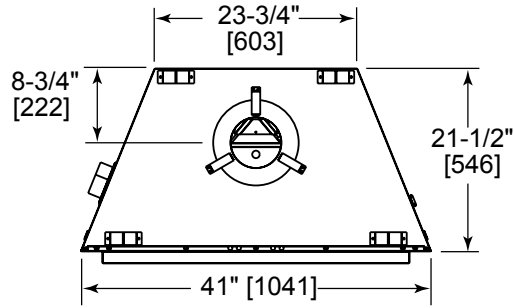

Top View

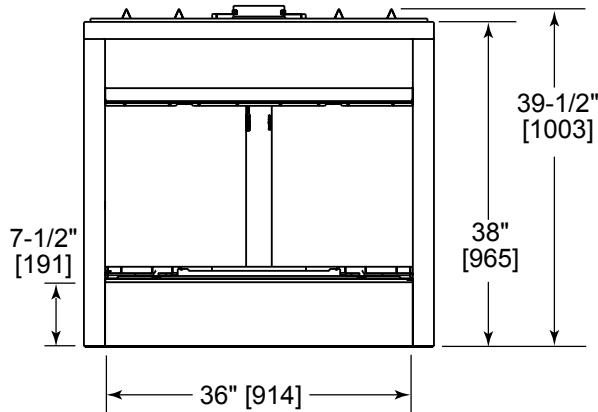

Front View

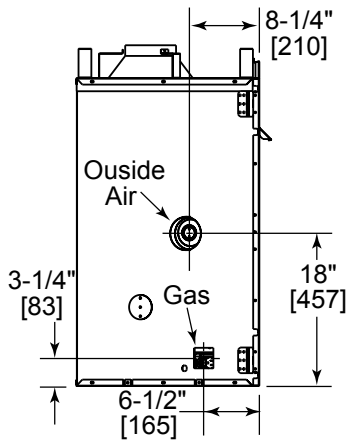

Left Side View

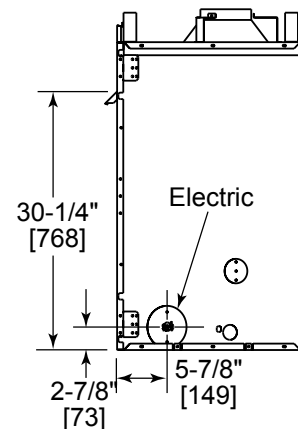

Right Side View

MINIMUM FIREPLACE CLEARANCES

AREA	TO COMBUSTIBLES
Clearance to ceiling	30"
Combustible/Non-combustible floor	0"
Sides of appliance	0"
Front of appliance	36"

APPLIANCE LOCATION

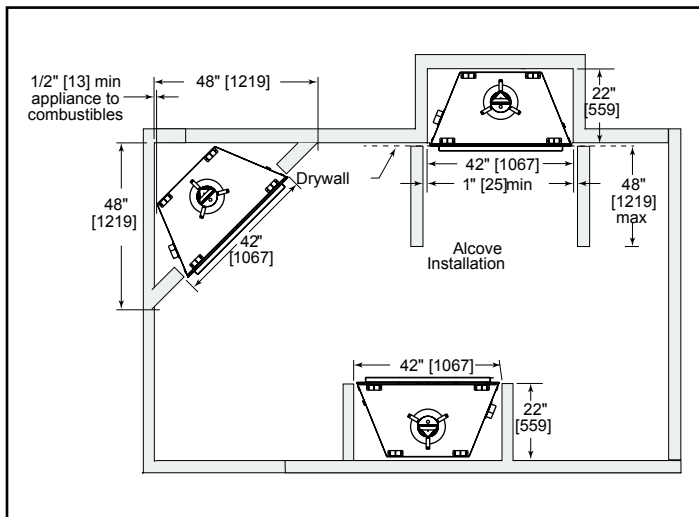

MANTEL LEG/WALL PROJECTIONS

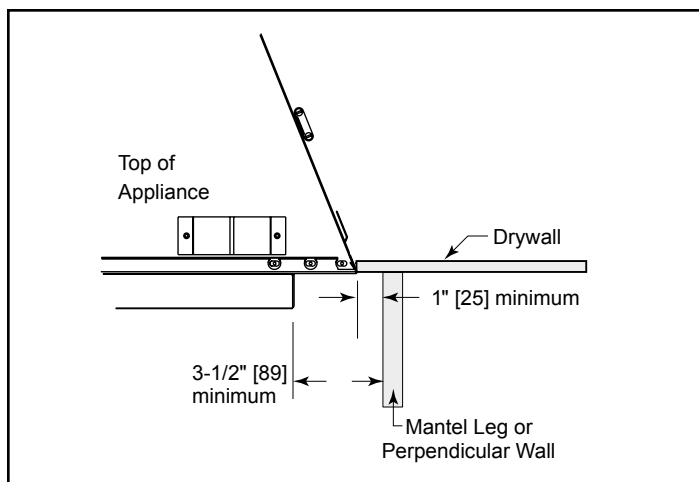

PRODUCT LISTING CODES	
US	ANSI Z21.50a-2008
CAN	CSA 2.22a-2008
 LISTED	UL307B

Product information provided is not complete and is subject to change without notice. Product installation must adhere strictly to instructions accompanying product to avoid risk of fire and potential injury. Additional information can be found online at www.heatilator.com.

FRAMING DIMENSIONS

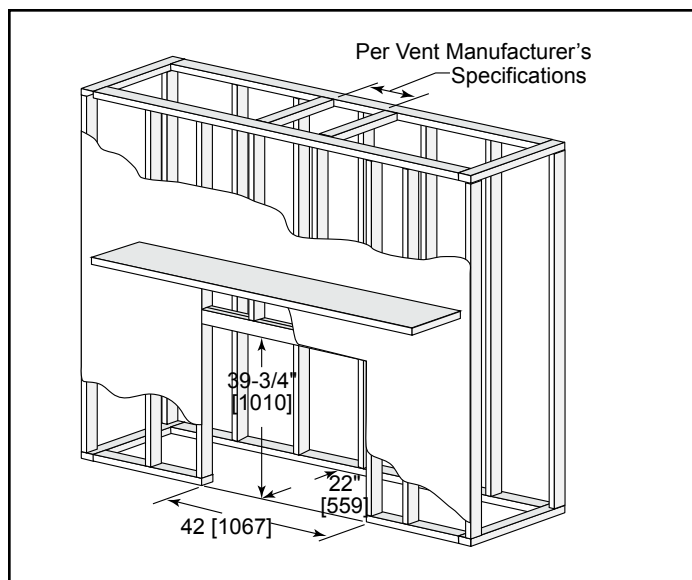

CLEARANCES TO COMBUSTIBLES

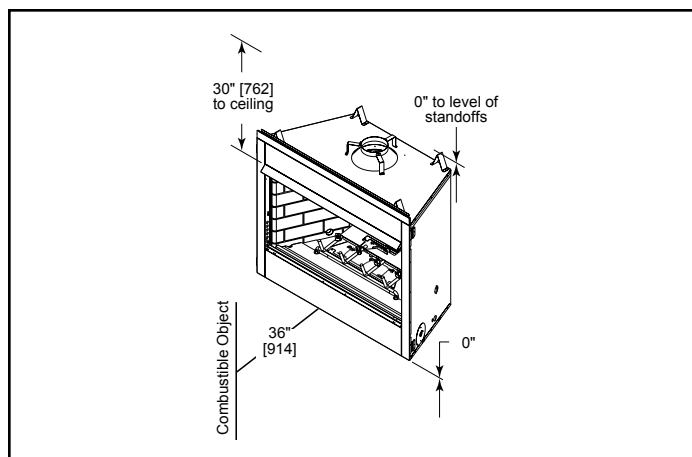

MANTEL PROJECTIONS

