



PRIMO II 60

Direct Vent Gas Fireplace

Scan QR code for installation manual for final dimensions and requirements.



ACTUAL DIMENSIONS	FRONT WIDTH	HEIGHT	DEPTH	GLASS SIZE	BTU/HOUR INPUT
	76-3/8" [1940]	40-13/16" [1037]	18-1/4" [464]	60" x 18" [1524 X 457]	39,500 - 57,000 BTUs (NG) 36,500 - 50,000 BTUs (LP)

TOP VIEW

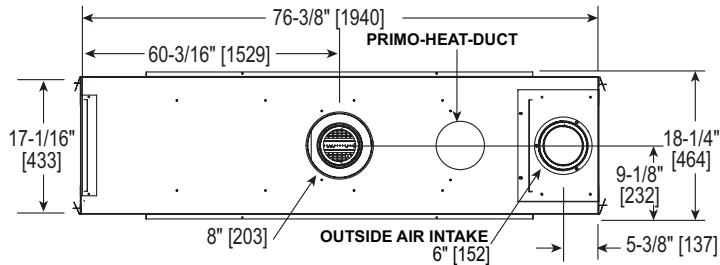

LEFT SIDE

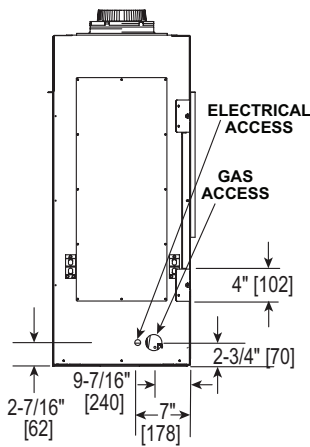

FRONT VIEW

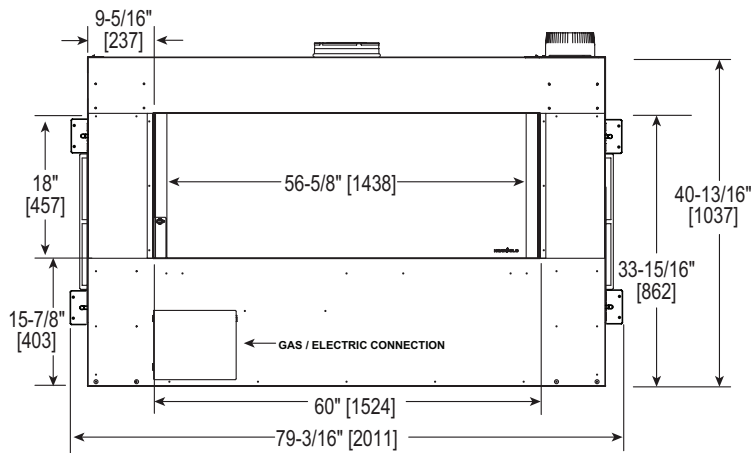

RIGHT SIDE

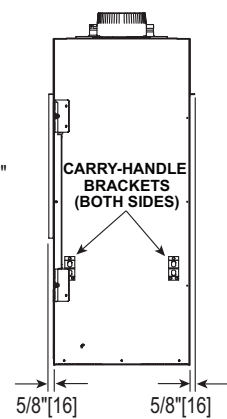

FRAMING DIMENSIONS	FRONT WIDTH	HEIGHT	DEPTH	WEIGHT
	78-3/4" [2000]	45" [1143]	18" [457]	417 LBS [189 KGS]

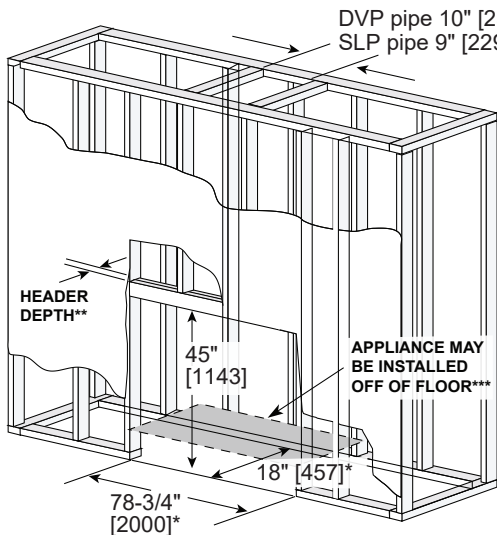

*Adjust framing dimensions for interior chase sheathing (such as 1/2" drywall)

** Header depth not to exceed 5-1/2". If header depth is greater than 3-1/2", header must be notched in order to maintain clearance to pipe.

*** If appliance is installed off of floor, maintain required clearances to combustibles. Construct platform in accordance to local building codes.

BASIC CORNER INSTALLATION

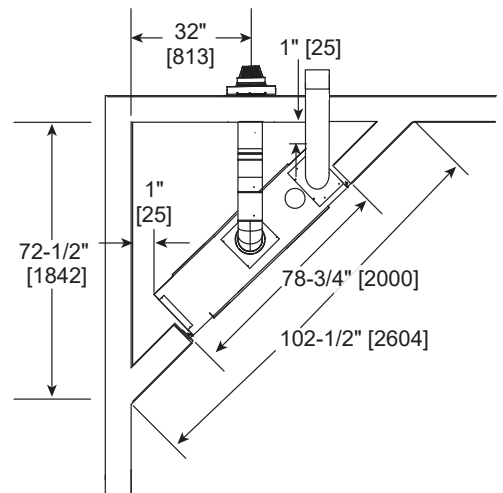

Reference install manual for additional venting scenarios

COMBUSTIBLE OR NON-COMBUSTIBLE MANTELS

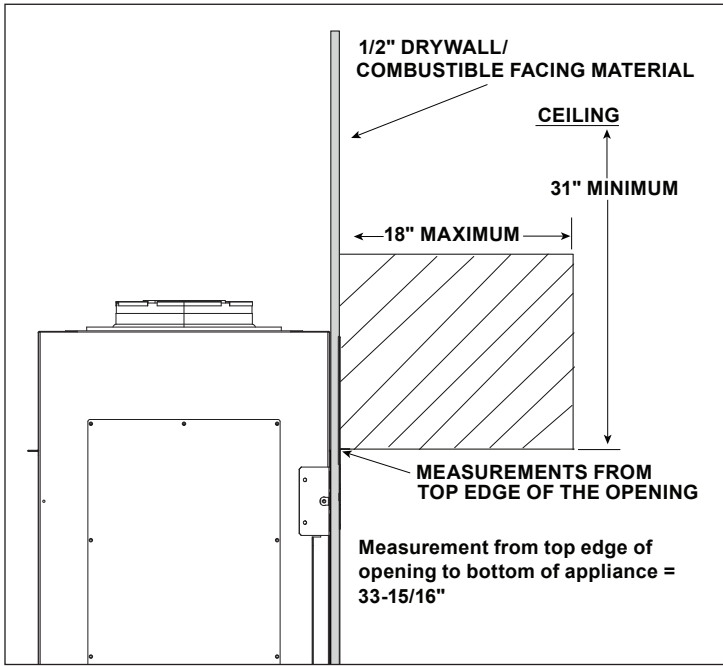

COMBUSTIBLE OR NON-COMBUSTIBLE MANTEL LEGS OR WALL PROJECTIONS

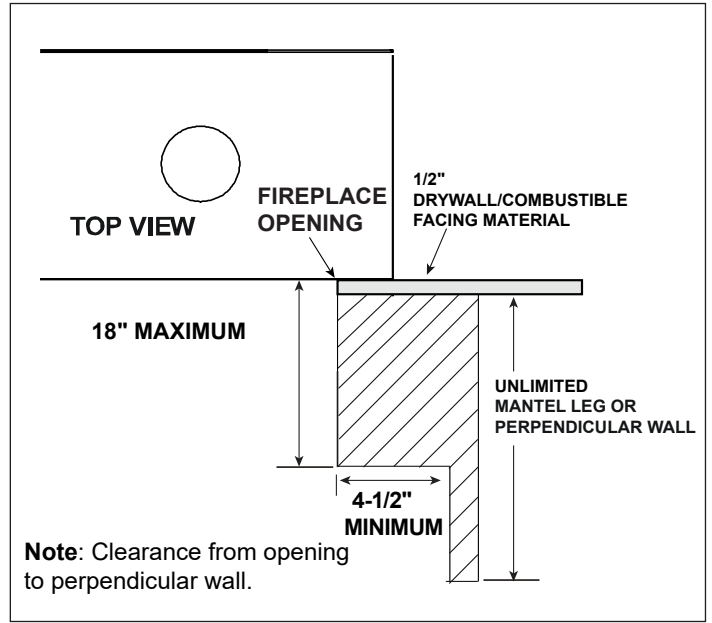

EXTERIOR CHASE MINIMUM HEIGHT REQUIREMENTS

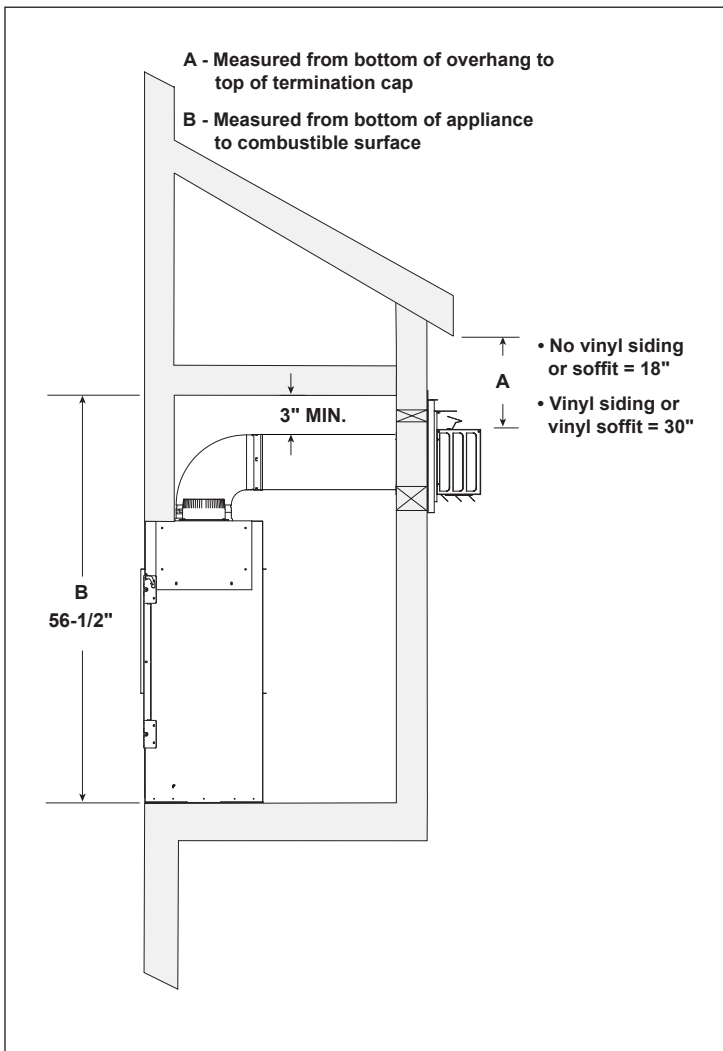

WALL PENETRATION

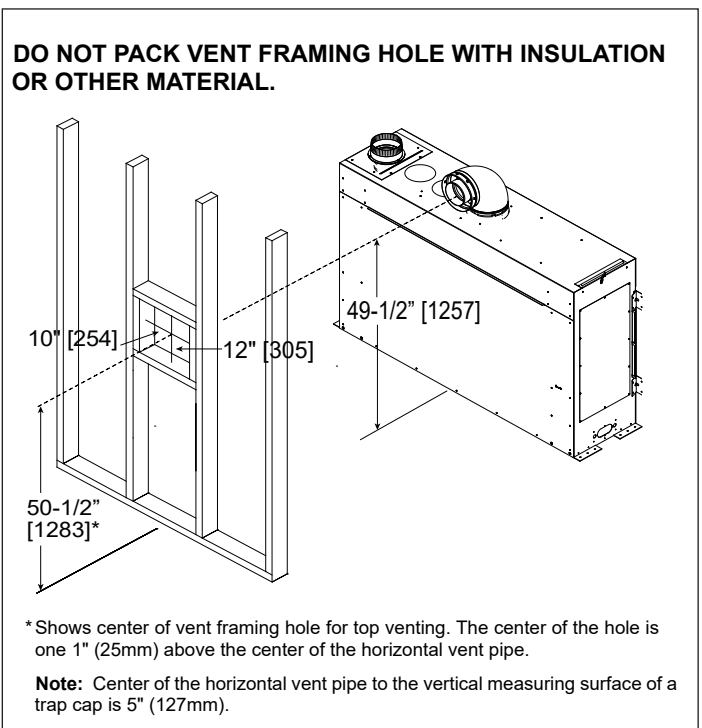

PRODUCT LISTING CODES	
US	ANSI Z21.50-2019
CAN	CSA 2.22-2019

Product information provided is not complete and is subject to change without notice. Product installation must adhere strictly to instructions accompanying product to avoid risk of fire and potential injury.



HEAT & GLO

No one builds a better fire

Heat & Glo — A Brand of Hearth & Home Technologies
 7571 215th Street West | Lakeville, MN 55044
 877-486-9123 | heatnglo.com