

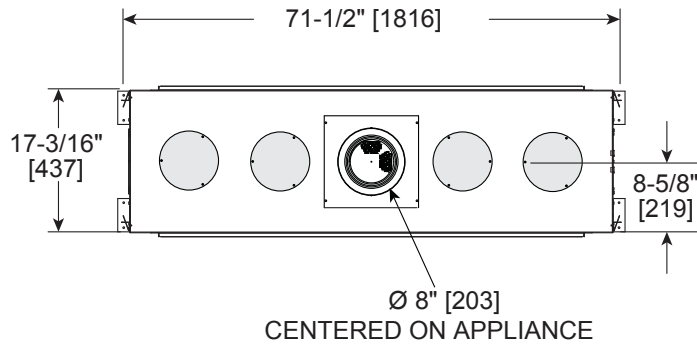

Please consult the manufacturer's installation manual for all details and requirements before making a final design layout decision.

**PRIMO60ST**  
60" See-Through  
Direct Vent Gas Fireplace

MODEL	FRONT WIDTH		BACK WIDTH		HEIGHT		DEPTH		GLASS SIZE
	Actual	Framing	Actual	Framing	Actual	Framing	Actual	Framing	
PRIMO60ST	71-1/2	72-1/4	71-1/2	72-1/4	30-9/16	48	17-3/16	17	59-1/2 x 12-1/2



Top

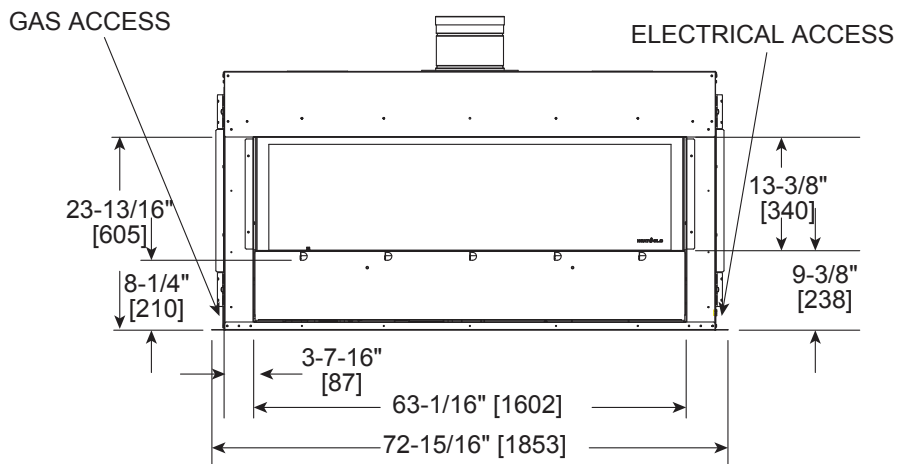

Front

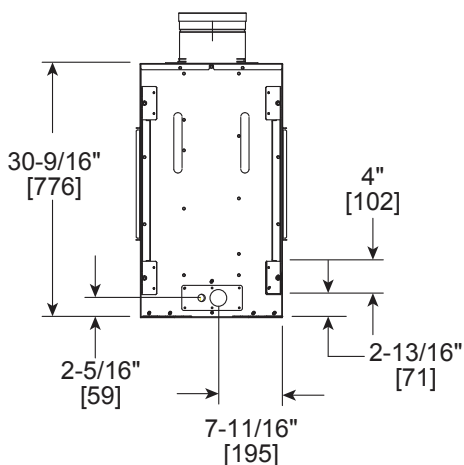

Left

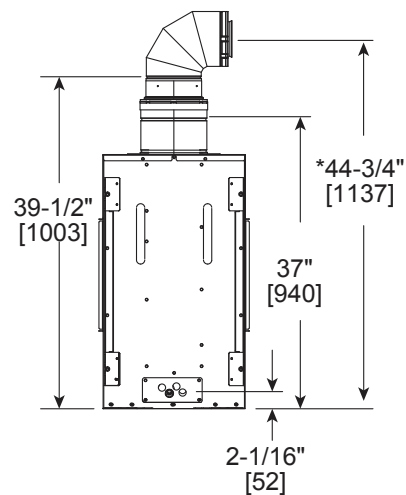

\*Minimum Vent Height (using SLP90)

Right

FINISHED OPENING DIMENSIONS

NOTE: Sheetrock (1/2") may be installed up to appliance opening.

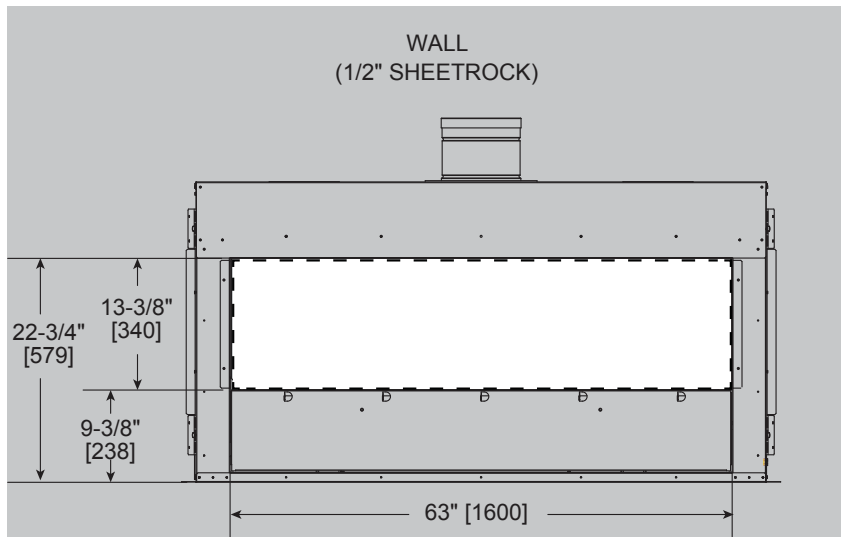

Clean Face Finish (Black Glass Interior)

NOTE: Sheetrock (1/2") may be installed up to appliance opening.

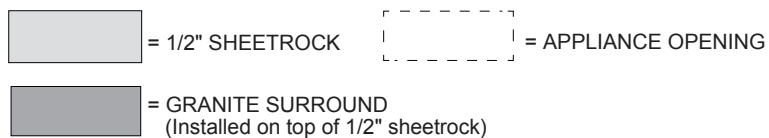
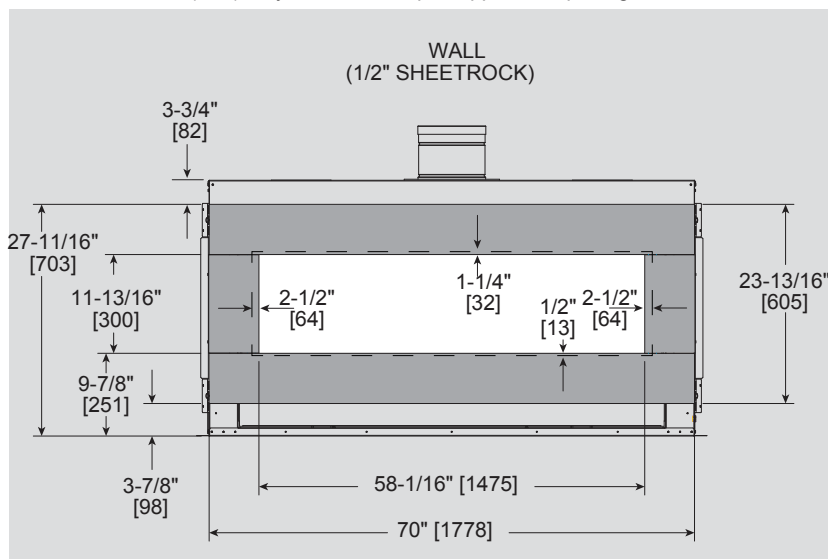

Black Granite Surround Finish (Black Glass Interior)

**APPLIANCE LOCATION**

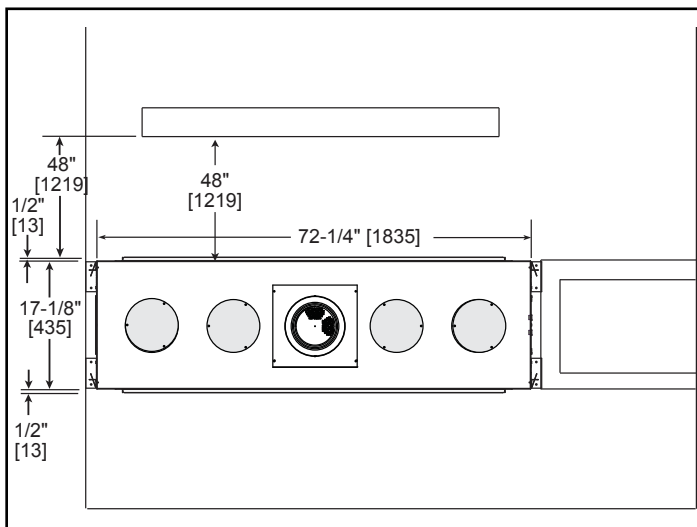

**FRAMING DIMENSION**

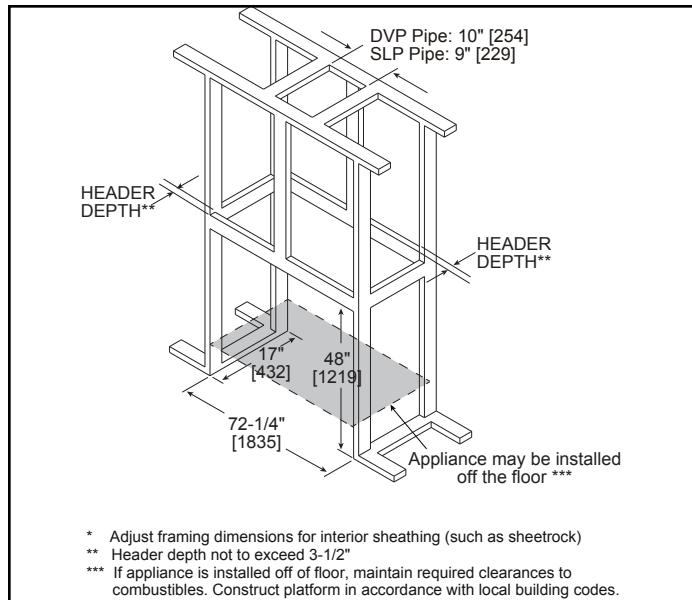

**MANTEL PROJECTIONS**

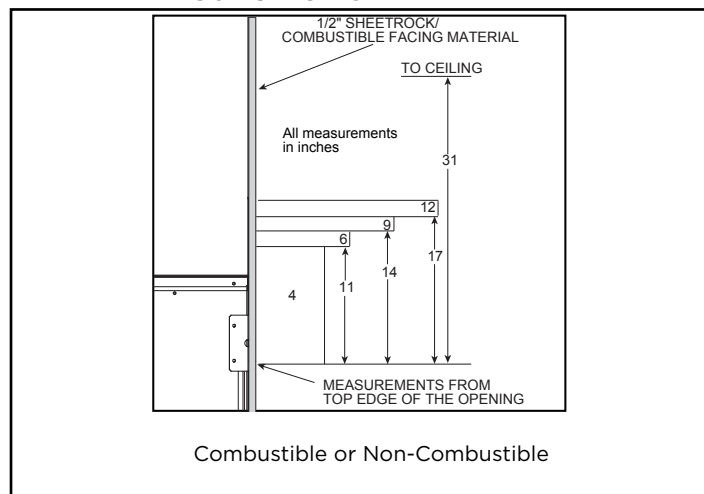

**CLEARANCES TO COMBUSTIBLES**

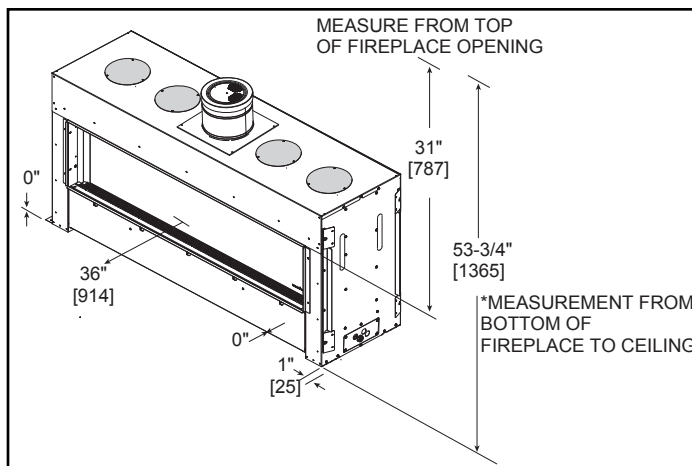

**MANTEL LEG/WALL PROJECTIONS - EXTENDING PAST THE FACE OF THE FIREPLACE**

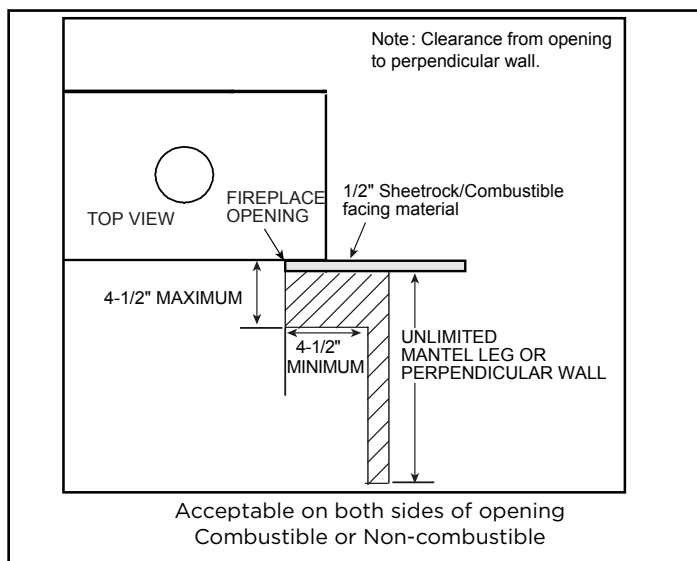

**WALL PENETRATION**

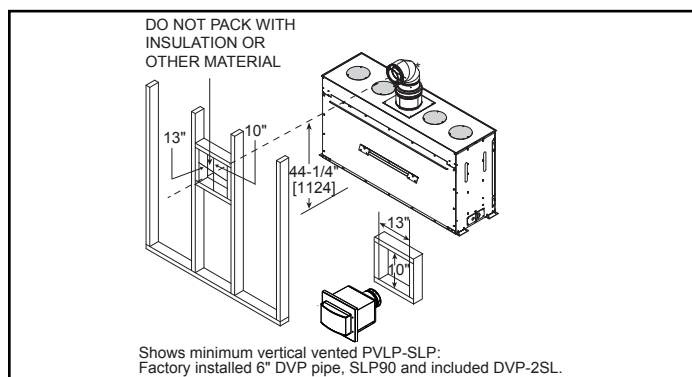

PRODUCT LISTING CODES	
US	ANSI Z21.50-2014
CAN	CSA 2.22-2014
US LISTED	UL307B

Product information provided is not complete and is subject to change without notice. Product installation must adhere strictly to instructions accompanying product to avoid risk of fire and potential injury.

Additional information can be found online at [www.heatnglo.com](http://www.heatnglo.com)