



Please consult the manufacturer's installation manual for all details and requirements before making a final design layout decision.

Novus NNXT3933

Direct Vent Gas Fireplace

MODEL	FRONT WIDTH		BACK WIDTH		HEIGHT		DEPTH		VIEWING AREA
	Actual	Framing	Actual	Framing	Actual	Framing	Actual	Framing	
NNXT3933	38	39	11-5/8	39	34	34-7/8	19-1/8	19-5/8	33 x 22-5/8

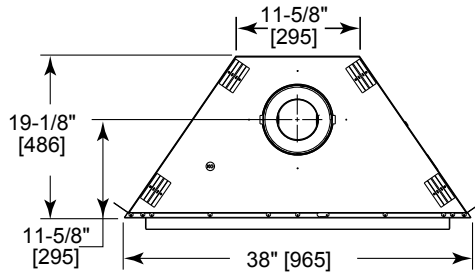

Top View

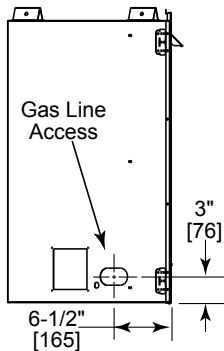

Left View

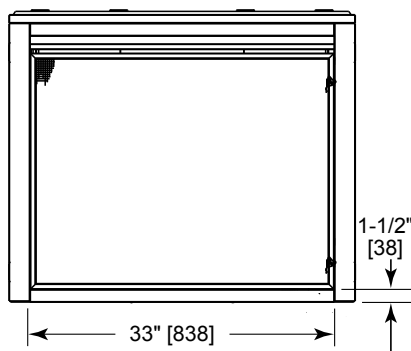

Front View

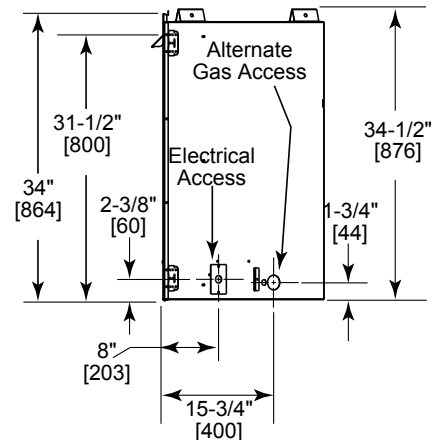

Right View

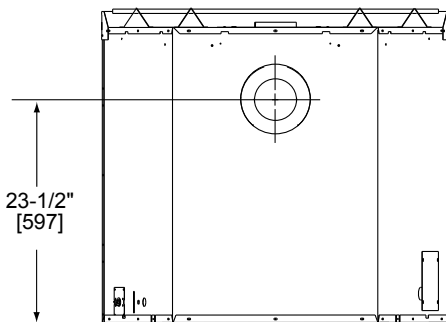

Rear View

MINIMUM FIREPLACE CLEARANCES

AREA	TO COMBUSTIBLES (in inches)
CLEARANCE TO CEILING	30
COMBUSTIBLE/NON-COMBUSTIBLE FLOOR	0
SIDES OF APPLIANCE	0
FRONT OF APPLIANCE	36

APPLIANCE LOCATION

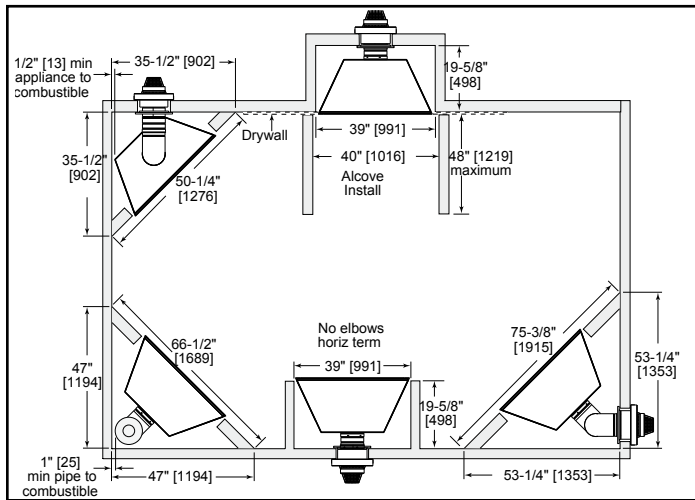

WALL PENETRATION

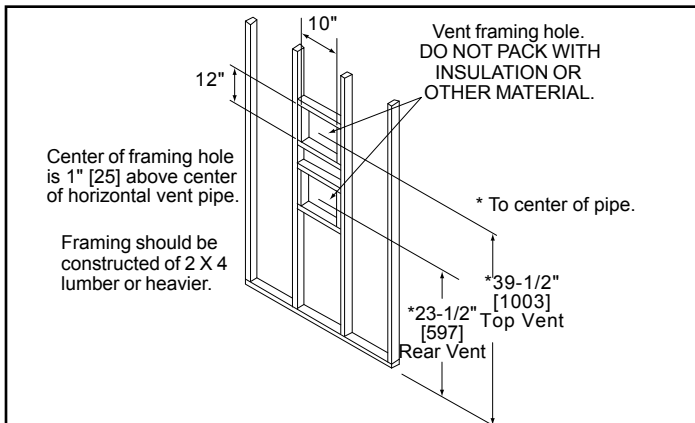

MANTEL LEG/WALL PROJECTIONS

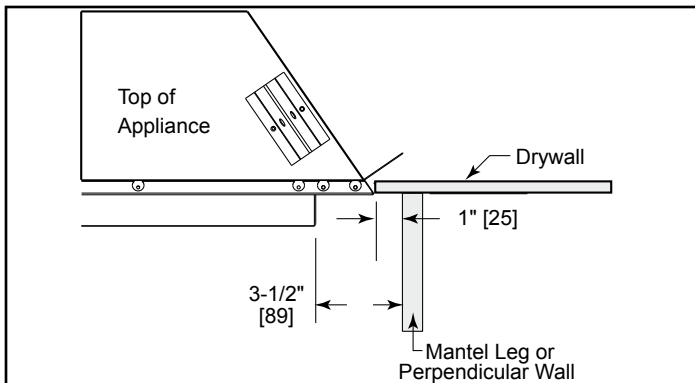

FRAMING DIMENSIONS

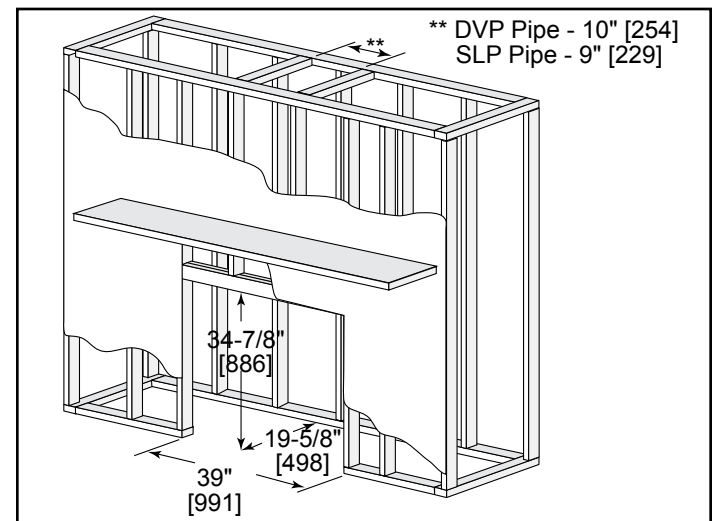

CLEARANCES TO COMBUSTIBLES

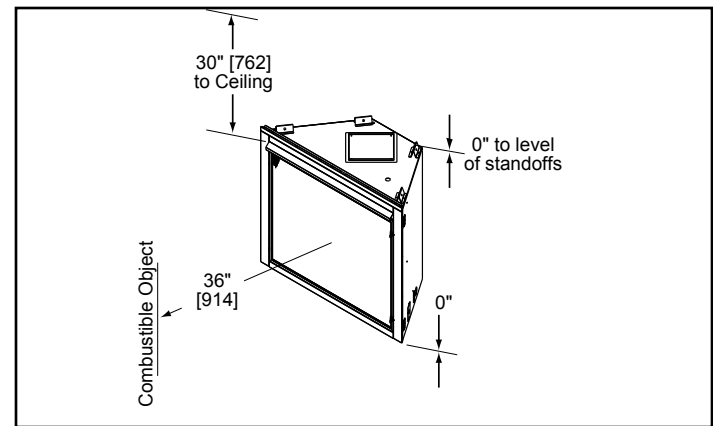

MANTEL PROJECTIONS

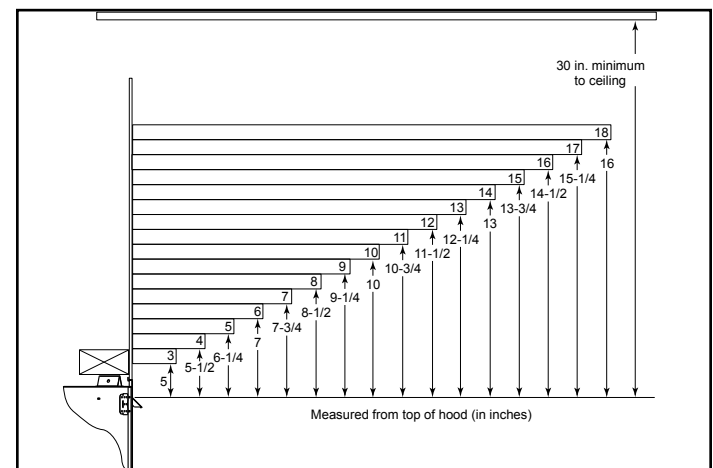

PRODUCT LISTING CODES	
US	ANSI Z21.88-2002
CAN	CSA 2.33-M2002
US LISTED	UL307B

Product information provided is not complete and is subject to change without notice. Product installation must adhere strictly to instructions accompanying product to avoid risk of fire and potential injury.

Additional information can be found online at www.heatilator.com