



Please consult the manufacturer's installation manual for all details and requirements before making a final design layout decision.

# Novus NEVO3630

Direct Vent Gas Fireplace

MODEL	FRONT WIDTH		BACK WIDTH		HEIGHT		DEPTH		VIEWING AREA
	Actual	Framing	Actual	Framing	Actual	Framing	Actual	Framing	
NEVO3630	35	36	8-5/8	36	39-1/8	39-7/8	19-1/8	19-5/8	30 x 22-5/8

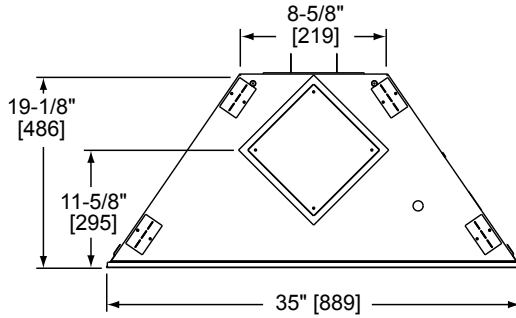

Top View

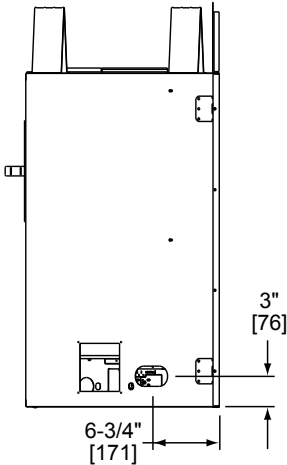

Left View

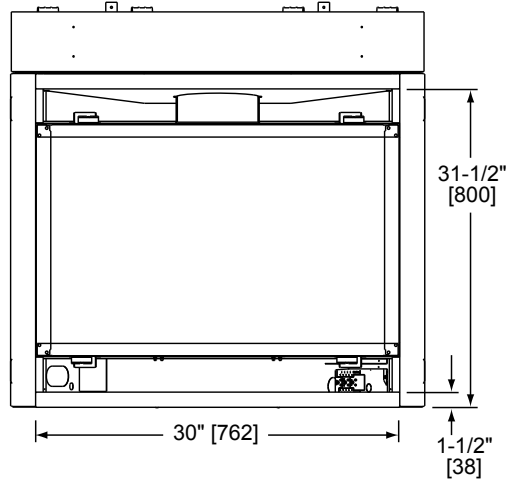

Front View

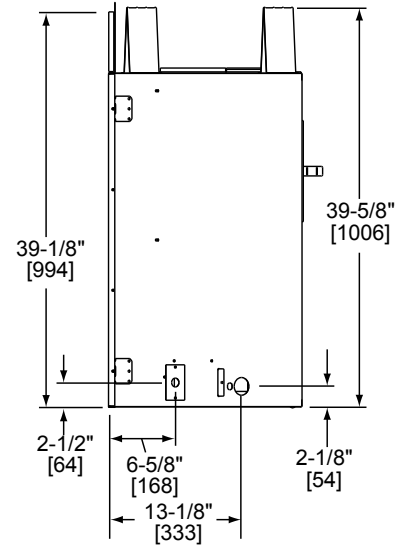

Right View

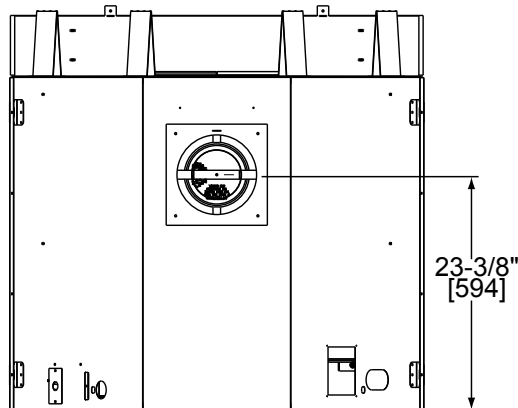

Rear View

**MINIMUM FIREPLACE CLEARANCES**

AREA	TO COMBUSTIBLES (in inches)
CLEARANCE TO CEILING	30
COMBUSTIBLE/NON-COMBUSTIBLE FLOOR	0
SIDES OF APPLIANCE	0
FRONT OF APPLIANCE	36

**APPLIANCE LOCATION**

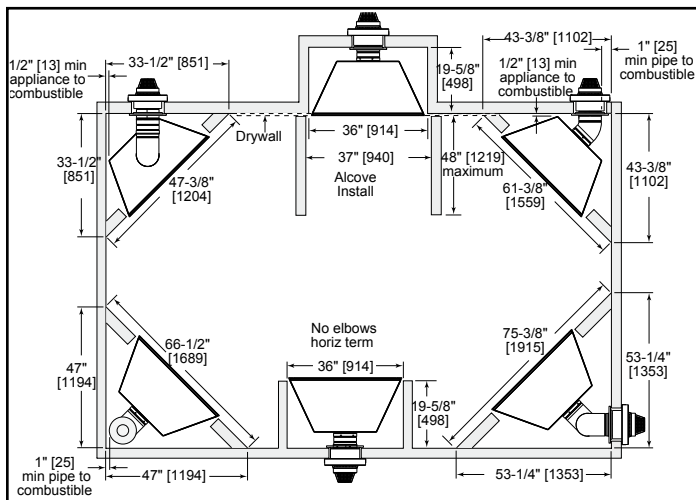

**WALL PENETRATION**

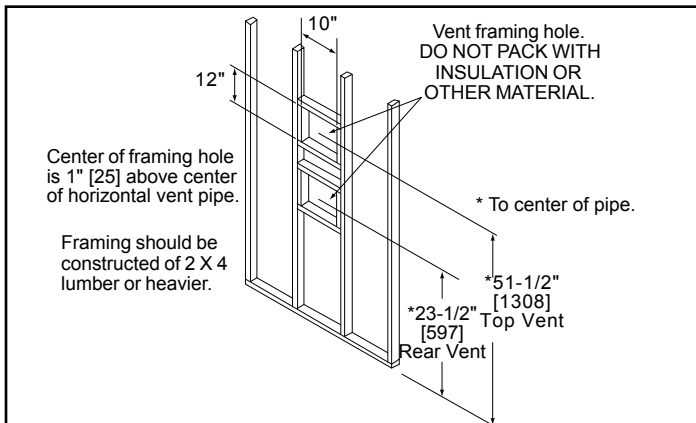

**MANTEL LEG/WALL PROJECTIONS**

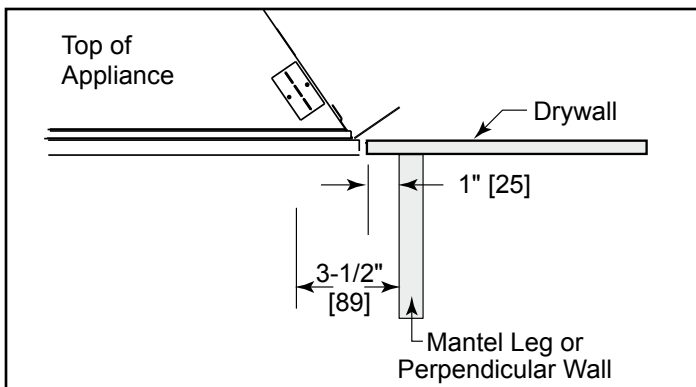

**FRAMING DIMENSIONS**

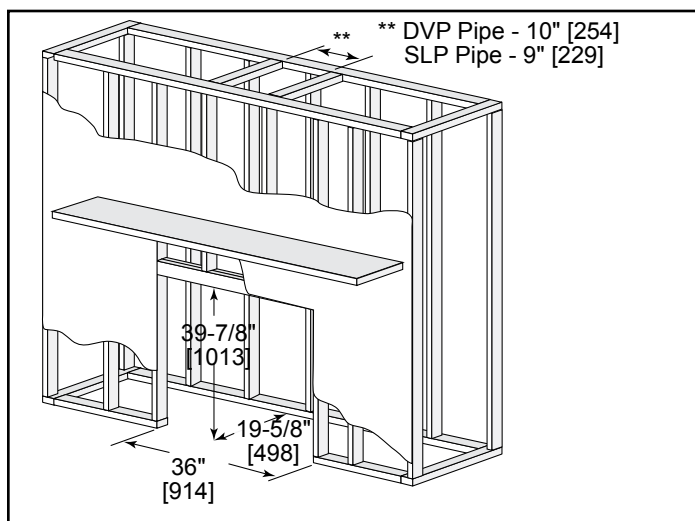

**CLEARANCES TO COMBUSTIBLES**

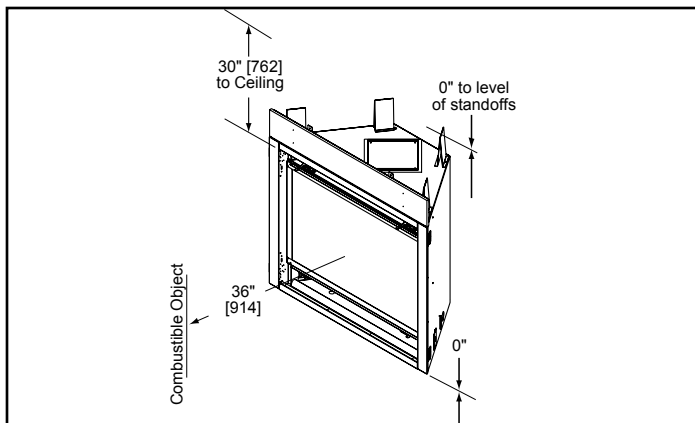

**MANTEL PROJECTIONS**

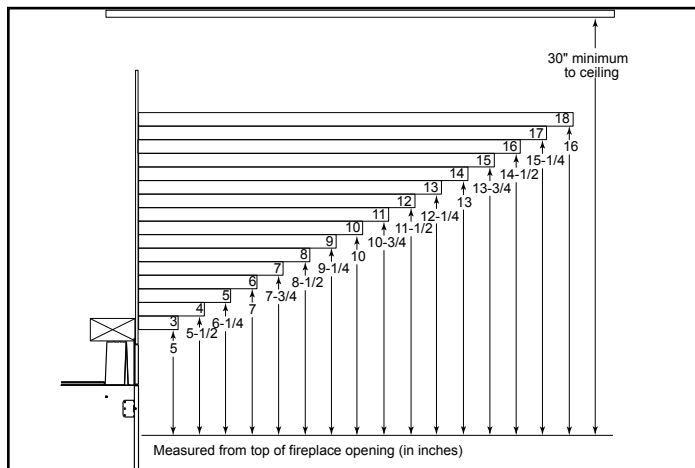

PRODUCT LISTING CODES	
US	ANSI Z21.88b-2008
CAN	CSA 2.33b-2008
US LISTED	UL307B

Product information provided is not complete and is subject to change without notice. Product installation must adhere strictly to instructions accompanying product to avoid risk of fire and potential injury.

Additional information can be found online at [www.heatilator.com](http://www.heatilator.com)