

PRODUCT SPECIFICATIONS

MCUF36D-R/MCUF36E-F Magnum Vent Free Firebox

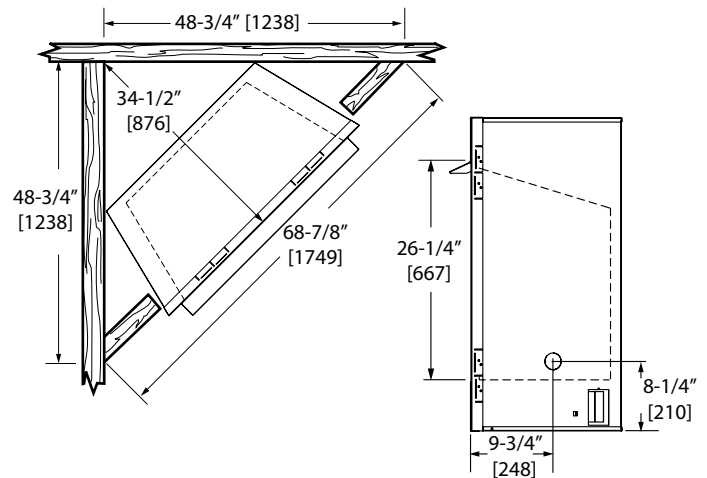

LOVE AT FIRST LIGHT

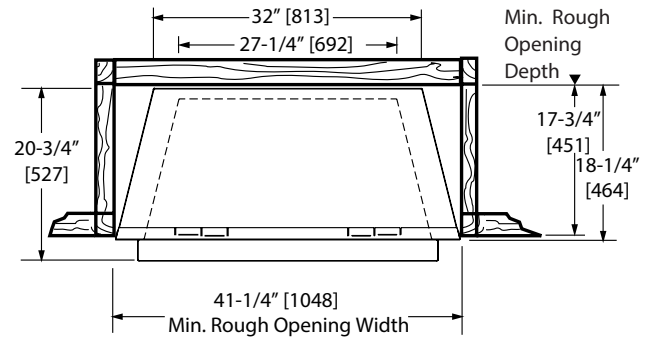
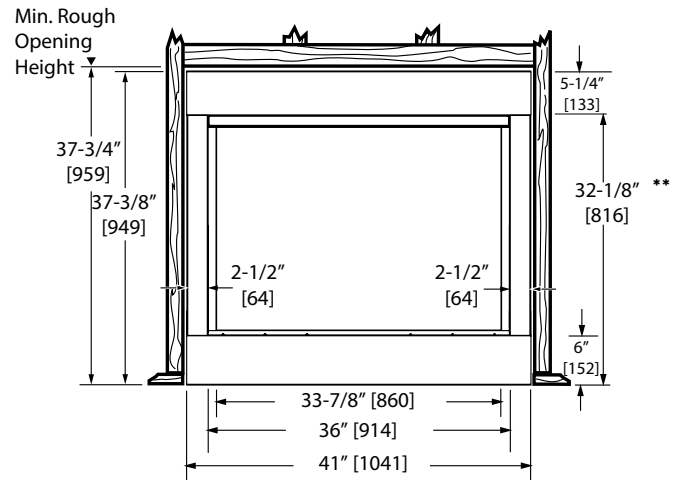

**Bracketed numbers are millimeters.

ACTUAL DIMENSIONS

- Actual size: 41"W x 37-3/8"H x 18-1/4"D x 32"RW
(1041 mm x 949 mm x 464 mm x 813 mm)
- Viewing area: 36"W x 26-1/4"H (945 sq in)
(914 mm x 667 mm) (6097 sq cm)
- Framing Dimensions: 41-1/4"W x 37-3/4"H x 17-3/4"D x 41-1/4"RW
(1048 mm x 959 mm x 451 mm x 1048 mm)

FACTORY INSTALLED FEATURES

- Refractory Herringbone firebrick (MCUF36D-R)
- Vintage Brown firebrick (MCUF36E-F)

FIELD INSTALLED ACCESSORIES

- Black curved trim - BLTKM36C
- Variable thermostat controlled forced air blower (160cfm) - BLOTMC
- Wood cabinet surround and hearths
- Designer facings
- Combustion air kit - AK4

TECHNICAL INFORMATION

- Clearance to combustibles*: zero
- CSA Design Certified

MINIMUM HEARTH DIMENSIONS

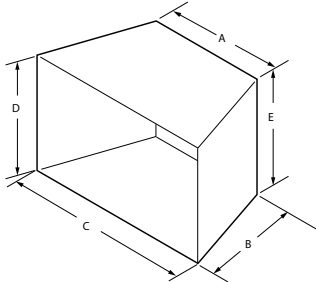

REF.	MCUF36E-F	MCUF36D-R
A	26-1/4" (667 mm)	25-3/4" (654 mm)
B	15" (384 mm)	14-3/4" (375 mm)
C	31-5/8" (803 mm)	32-1/8" (816 mm)
D	25" (635 mm)	25" (635 mm)
E	20-1/2" (521 mm)	20-1/2" (521 mm)

www.monessenhearth.com

*See manual for complete clearance information
To avoid personal injury or property damage, the product described by this brochure must be installed, operated and maintained in strict compliance with the instructions packaged with the product and all applicable building or fire codes. Contact local building or fire officials about restrictions and installation inspection requirements. All photographs and drawings on this brochure are for illustrative purposes only and are not intended for, nor should they be used as a substitute for the instructions packaged with the unit. Appearance and specifications of the product are subject to change without notice. 0716v2 © 2016 Hearth & Home Technologies®