

IMPORTANT: THIS IS DATED INFORMATION. Parts must be ordered from a dealer or distributor. **Hearth and Home Technologies does not sell directly to consumers.** Provide model number and serial number when requesting service parts from your dealer or distributor.



Stocked at Depot

ITEM	DESCRIPTION	COMMENTS	PART NUMBER
1	Non-combustible Board, Top	Qty 2 req	SRV2321-460
2	Standoff, Top	Qty 4 req	2604-283
3	Side Trim	Qty 4 req	2300-281
4	Non-combustible Board, Side Pkg of 2	Qty 2 req	2300-461
5	Bottom Glass		2321-018
6	Burner		2321-007
7	Pilot Assembly		See Following Page
8	Shield, Pilot		2300-195
9	Glass Assembly	Qty 2 req	GLA-60-HTL
10	Shield, Bottom Glass w/vents		2321-179
	Shield, Bottom Glass		2322-179
11	Panel, Bottom w/vents		2321-147
	Panel, Bottom		2322-147
12	Rock Tray		2321-151
13	Heat Shield, Front		2605-150
14	Heat Shield, Rear		2605-151

Additional service part numbers on following page.

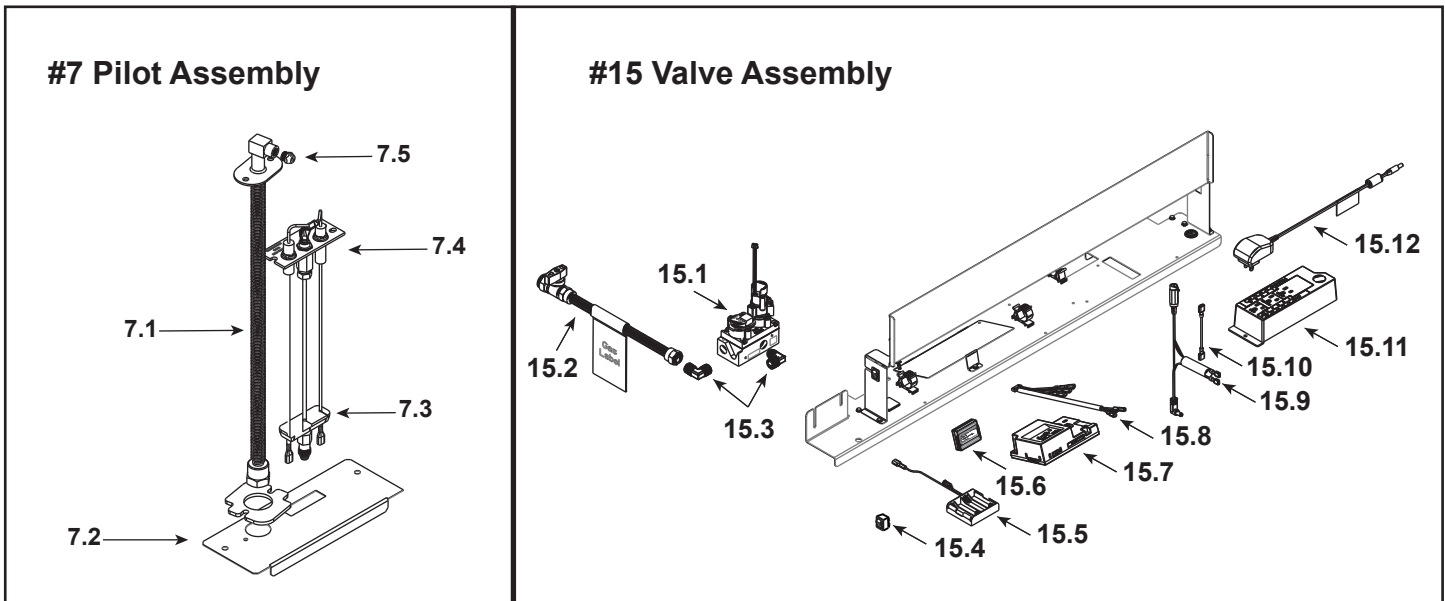

IMPORTANT: THIS IS DATED INFORMATION. Parts must be ordered from a dealer or distributor. **Hearth and Home Technologies does not sell directly to consumers.** Provide model number and serial number when requesting service parts from your dealer or distributor.



Stocked at Depot

ITEM	DESCRIPTION	COMMENTS	PART NUMBER	
7.1	Bulkhead w/Flex tube		SRV2166-119	Y
7.2	Plate, Flex and Pilot		2300-163	
7.3	3-Hole Grommet		SRV2118-420	
7.4	Pilot Assembly, NG		2406-012	Y
	Pilot Assembly, Propane	Convert 2406-012 with SRV593-527		Y
7.5	Orifice, NG #28C		582-828	Y
	Orifice, Propane #48C		SRV582-848	Y
15.1	Valve, NG		SRV2166-302	Y
	Valve, Propane		2166-303	Y
15.2	Flex Ball Valve Assembly		SRV2078-022	Y
15.3	Elbow	Qty 2 req	SRV4021-045	
15.4	Reset Switch	Propane Only	SRV2206-298	Y
15.5	Battery Pack**		SRV2326-134	Y
15.6	Module, RF		SRV2326-120	Y
15.7	Module, IFT Control		SRV2326-130	Y
15.8	Wire Harness		SRV2326-132	Y
15.9	Reset Switch Wire	Propane Only	SRV2326-135	Y
15.10	Jumper Wire, 2.5 inch		SRV2155-033	Y
15.11	Junction Box	Pre LC6668884	SRV4021-013	Y
		Post LC6668884	SRV2326-013	Y
15.12	Transformer, 6 Volt Wall		SRV2326-131	Y
	Component Insulation		2604-102	Y

**Fuse for battery pack can be sourced locally, not a warranty item. Specs are 250v, 3A fuse, 3/4" long

Additional service part numbers on following page.

IMPORTANT: THIS IS DATED INFORMATION. Parts must be ordered from a dealer or distributor. **Hearth and Home Technologies does not sell directly to consumers.** Provide model number and serial number when requesting service parts from your dealer or distributor.



Stocked at Depot

ITEM	DESCRIPTION	COMMENTS	PART NUMBER	
	Flue Restrictor		385-128	
	Fiber Glass Rope		060-455	
	Gasket Assembly Contains:Vent, Burner Neck, Seal Cap, Air Passage, Drawn Air Passage, and Flex and Pilot		2300-080	
	Glass Latch Assembly	Qty 8 req	2146-413	Y
	Heat Zone Collar Cover Plate		2310-107	
	Insulation Donut, Plug		2065-121	
	Log Assembly (Optional)		LOGS-60	
	Light Kit, Ambient (Optional)		ALK-60-C	
	Black Glass Kit (Includes Manual Bag Assembly for kit and Refractory Assembly, Optional)		BGK-LINEARST	
	Back Retaining Clips	Pkg of 25	060-235-25	
	Side Retaining Clip	1 Per Side	2406-104	
	RC 400 Remote		SRV2326-110	Y
	Touch Up Paint		TUP-GBK-12	
	Vinyl Siding Shield		TRAP-VSS	
Media Options				
	Media Kit, Red		MEDIA-RED-60	
	Media Kit, Ebony		MEDIA-EBONY-60	
	Media Kit, Cobalt		MEDIA-COBALT-60	
	Media Kit, Clear		MEDIA-CLEAR-60	
	Media Kit, Amber		MEDIA-AMBER-60	
Conversion Kits				
	Conversion Kit NG		NGK-MC-C	Y
	Conversion Kit Propane		LPK-7260	
	Pilot Orifice, NG		SRV593-528	Y
	Pilot Orifice, Propane		SRV593-527	Y
	Regulator, NG		NGK-DXV-50	Y
	Regulator, Propane		SRVLPK-DXV-50	Y