

# Owner's Manual

## Operation & Care

**INSTALLER:** Leave this manual with party responsible for use and operation.  
**OWNER:** Retain this manual for future reference.

Contact your dealer with questions on installation, operation, or service.

**NOTICE: DO NOT DISCARD THIS MANUAL**

 **heatilator**  
**ECOCHOICE**<sup>™</sup>  
PELLET BURNING STOVES

**MODEL(S):**  
**ECO-ADV-PS35**  
**ECO-ADV-PS50**  
**ECO-CAB50**

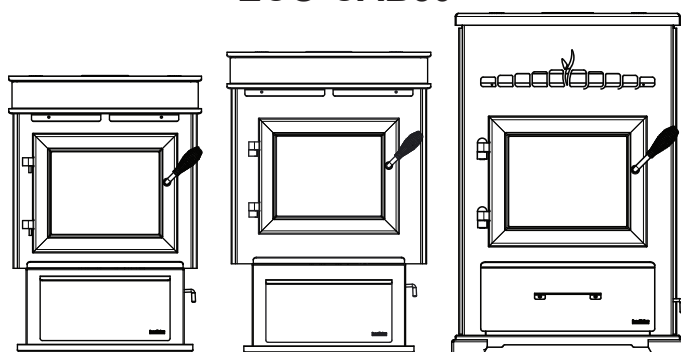

This appliance has been retired.  
Service parts pages within have been removed.  
For replacement parts, please refer to the individual  
service parts list located on the brand websites.

### **WARNING**



If the information in these instructions is not followed exactly, a fire could result causing property damage, personal injury, or death.

- Do not store or use gasoline or other flammable vapors and liquids in the vicinity of this or any other appliance.
- Do not over fire - If appliance or chimney connector glows, you are over firing. Over firing will void your warranty.
- Comply with all minimum clearances to combustibles as specified. Failure to comply may cause house fire.

### **WARNING**



#### **HOT SURFACES!**

Glass and other surfaces are hot during operation AND cool down.  
Hot glass will cause burns.

- Do not touch glass until it is cooled
- NEVER allow children to touch glass
- Keep children away
- CAREFULLY SUPERVISE children in same room as fireplace.
- Alert children and adults to hazards of high temperatures
- **High temperatures may ignite clothing or other flammable materials.**
- Keep clothing, furniture, draperies and other flammable materials away.

### **CAUTION**

Check building codes prior to installation.

- Installation **MUST** comply with local, regional, state and national codes and regulations.
- Consult local building, fire officials or authorities having jurisdiction about restrictions, installation inspection, and permits.

Installation and service of this appliance should be performed by qualified personnel. Hearth & Home Technologies recommends HHT Factory Trained or NFI certified professionals.



### **CAUTION**

Tested and approved for wood pellets, Burning of any other type of fuel voids your warranty.

### **NOTE**

To obtain a French translation of this manual, please contact your dealer or visit [www.heatilator.com](http://www.heatilator.com).

Pour obtenir une traduction Française de ce manuel, s'il vous plait contacter votre revendeur ou visitez [www.heatilator.com](http://www.heatilator.com).

*Congratulations* 

and Welcome to the Quadra-Fire Family!

**NOTE:** Clearances may only be reduced by means approved by the regulatory authority having jurisdiction

**A. Sample of Serial Number / Safety Label**

LOCATION: On chain behind right access panel & Behind left access panel

**Test Lab and Report Number**

**Model Name**

ECO-ADV-PS35

Serial No. / N° de série

HF

**Serial Number**

**CAUTION: HOT WHILE IN OPERATION DO NOT TOUCH, KEEP CHILDREN, CLOTHING AND FURNITURE AWAY. CONTACT MAY CAUSE SKIN BURNS. SEE NAMEPLATE AND INSTRUCTIONS.**

**ATTENTION: CHAUD LORS DE L'OPÉRATION. NE PAS TOUCHER. GARDEZ LES ENFANTS ET LES VÊTEMENTS LOIN DE L'ESPACE DÉSIGNÉ DE L'INSTALLATION. LE CONTACT PEUT CAUSER DES BRÛLURES À LA PEAU. VOIR L'ÉTIQUETTE ET LES INSTRUCTIONS.**

**PREVENTION OF HOUSE FIRE**

Installez et utilisez en accord avec les instructions d'installation et d'opération du fabricant. Contactez le bureau de la construction ou le bureau des incendies au sujet des restrictions et des inspections d'installation dans votre zone. Ne pas bloquer l'espace en dessous de l'appareil.

**AVIS - Précautions de sécurité :** Ne pas installer dans une chambre à coucher. Un tuyau extérieur de combustion doit être installé et pas être obstrué lorsque l'appareil est en usage. La structure intérieure (plancher, plafond et murs de la maison mobile) doit être maintenue intacte. Référez-vous aux instructions du fabricant et des codes locaux pour les précautions requises pour passer le cheminée à travers un mur ou un plafond combustibles, et les compensations maximums. Remplacez fréquemment la cheminée fréquemment. Ne pas connecter cet appareil à une cheminée servant un autre appareil, système de ventilation "L" ou "P" diamètre 76mm ou 102mm.

**MINIMUM CLEARANCES TO COMBUSTIBLE MATERIALS / ESPACES LIBRES MINIMUM DES MATÉRIEAUX COMBUSTIBLES:**

A	Back Wall / Mur Arrière	2 in/51mm
B	Side Wall / Mur De Côté	14 in/356mm
C	CORNER INSTALLATION / INSTALLATION DU COIN :	
C	Side Wall / Mur De Côté	2 in/51mm
<b>VERTICAL 3 in. - 3 in. ADAPTER KIT (PART 811-0860) INSTALLATION:</b>		
<b>UN ASSEMBLAGE POUR ADAPTEUR 3-3 in (76-76mm) POUR INSTALLATION VERTICALE:</b>		
D	Pipe to Back Wall / Un Tuyau Mur Arrière	1 in/25mm
E	Side Wall / Mur De Côté	14 in/356mm
F	Back Wall / Mur Arrière	6,25 in/159mm
<b>CORNER INSTALLATION WITH VERTICAL ADAPTER KIT:</b>		
<b>INSTALLATION DU COIN AVEC UN ASSEMBLAGE D'ADAPTEUR VERTICAL:</b>		
G	Side Wall / Mur De Côté	2 in/51mm
<b>ALCOVE INSTALLATION / INSTALLATION DE L'ALCÔVE:</b>		
	Min. Alcove Height / Une hauteur minimum de l'alcôve	51,75 in/1314mm
	Min. Alcove Side Wall / Une hauteur minimum mur de côté de l'alcôve	14 in/356mm
	Min. Alcove Width / Une épaisseur minimum mur de côté de l'alcôve	50,25 in/1276mm
	Max. Alcove Depth / La profondeur maximum de l'alcôve	48 in/1219mm
	Max. Mantle Depth / Profondeur maximum de la mantel de cheminée	36 in/914mm
	Top of Unit to Combustibles / Vue du haut des matériaux combustibles	21 in/533mm

**FLOOR PROTECTION / PROTECTION DU SOL**

Floor protector must be non-combustible material, extending beneath heater and to the front/sides/rear as indicated. Measure front distance (I) from the surface of the glass door.

Le poêle doit être placé sur une assise non combustible s'étendant tout autour de lui, comme les schémas l'indiquent. Mesurez la distance du devant (I) de la surface de la porte vitrée.

\*Non-combustible floor protection must extend 2 inches (51mm) beneath the flue pipe when installed with horizontal venting or under the Top Vent Adapter with vertical installation.

\*Un protecteur incombustible de plancher doit s'étendre 2 inches (51mm) sous le conduit de cheminée pour une installation de ventilation horizontale ou sous un adaptateur de ventilation de dessus pour une installation verticale.

**RECOMMENDED IN USA; REQUIRED IN CANADA. ÉTATS-UNIS - RECOMMANDÉ; CANADA - REQUIERT.**

**U.S. ENVIRONMENTAL PROTECTION AGENCY**

Certified to comply with 2015 particulate emission standards at 2.1 g/hr EPA method 28 and 95. Not approved for sale after May 15, 2020.

This wood heater meets periodic inspection and repair for proper operation. Consult the owner's manual for further information. It is regulated federal regulations to operate this wood heater in a manner inconsistent with the operating instructions in the owner's manual.

2017	2018	2019	JAN	FEB	MAR	APR	MAY	JUN	JUL	AUG	SEP	OCT	NOV	DEC
<input type="checkbox"/>	<input type="checkbox"/>	<input type="checkbox"/>	<input type="checkbox"/>	<input type="checkbox"/>	<input type="checkbox"/>	<input type="checkbox"/>	<input type="checkbox"/>	<input type="checkbox"/>	<input type="checkbox"/>	<input type="checkbox"/>	<input type="checkbox"/>	<input type="checkbox"/>	<input type="checkbox"/>	<input type="checkbox"/>

DO NOT REMOVE THIS LABEL / NE PAS ENLEVER L'ÉTIQUETTE

Made in U.S.A. of US and imported parts. / Fabriqué aux États-Unis-d'Amérique par des pièces d'origine américaine et pièces importées.

**Manufacturer Date**

**Safety Alert Key:**

- **DANGER!** Indicates a hazardous situation which, if not avoided will result in death or serious injury.
- **WARNING!** Indicates a hazardous situation which, if not avoided could result in death or serious injury.
- **CAUTION!** Indicates a hazardous situation which, if not avoided, could result in minor or moderate injury.
- **NOTICE:** Indicates practices which may cause damage to the appliance or to property.

**TABLE OF CONTENTS**

A. Sample of Serial Number / Safety Label . . . . .	2	<b>4 Troubleshooting Guide.....</b>	<b>21</b>
B. Warranty Policy . . . . .	4	<b>5 Service Parts Replacement.....</b>	<b>24</b>
C. Quick Start Guide . . . . .	6	A. Convection Blower Replacement . . . . .	24
<b>1 Listing and Code Approvals .....</b>	<b>7</b>	B. Exhaust Blower Replacement . . . . .	25
A. Appliance Certification . . . . .	7	C. Snap Disc Replacements . . . . .	25
B. BTU & Efficiency Specifications . . . . .	7	D. Igniter Replacement . . . . .	26
C. Glass Specifications . . . . .	8	E. Baffle Removal & Replace . . . . .	26
D. Electrical Rating (on high) . . . . .	8	F. Glass Replacement . . . . .	27
E. Mobile Home Approved . . . . .	8	<b>6 Reference Materials .....</b>	<b>28</b>
F. Sleeping Room . . . . .	8	A. Component Functions . . . . .	28
G. California - Prop65 . . . . .	8	B. Component Locations . . . . .	30
<b>2 Operating Instructions .....</b>	<b>9</b>	C. Maintenance and Service Log. . . . .	31
A. Fire Safety . . . . .	9	D. Exploded Drawings & Service Parts - PS35 . . . . .	32
B. Non-Combustible Materials . . . . .	9	E. Exploded Drawings & Service Parts - PS50 . . . . .	36
C. Combustible Materials . . . . .	9	F. Exploded Drawings & Service Parts - CAB50 . . . . .	40
D. Fuel Material and Fuel Storage . . . . .	9		
E. General Operating Information . . . . .	10		
F. Before Your First Fire . . . . .	10		
G. Hopper Lid Latch and Hopper Switch . . . . .	11		
H. Starting Your First Fire . . . . .	11		
I. Fire Characteristics . . . . .	12		
J. Feed Rate Adjustment Instructions . . . . .	12		
K. Ignition Cycles . . . . .	12		
L. Clear Space . . . . .	12		
M. Frequently Asked Questions . . . . .	13		
<b>3 Maintenance and Service .....</b>	<b>15</b>		
A. Proper Shutdown Procedure . . . . .	15		
B. Quick Reference Maintenance Chart . . . . .	15		
C. General Maintenance . . . . .	16		
D. High Ash Fuel Content Maintenance . . . . .	20		
E. Soot or Creosote Fire . . . . .	20		

Heatilator is a registered trademark of Hearth & Home Technologies.

**B. Warranty Policy**

**Hearth & Home Technologies Inc.**

**HEATILATOR ECO-CHOICE WARRANTY**

Hearth & Home Technologies Inc., on behalf of its hearth brands (“HHT”), extends the following warranty for ECO-CHOICE by heatilator wood and pellet hearth appliances that are purchased from an HHT authorized dealer.

**WARRANTY COVERAGE:**

HHT warrants to the original owner of the HHT appliance at the site of installation, and to any transferee taking ownership of the appliance at the site of installation within two years following the date of original purchase, that the HHT appliance will be free from defects in materials and workmanship at the time of manufacture. After installation, if covered components manufactured by HHT are found to be defective in materials or workmanship during the applicable warranty period, HHT will, at its option, repair or replace the covered components. HHT, at its own discretion, may fully discharge all of its obligations under such warranties by replacing the product itself or refunding the verified purchase price of the product itself. The maximum amount recoverable under this warranty is limited to the purchaser price of the product. This warranty is subject to conditions, exclusions and limitations as described below.

**WARRANTY PERIOD:**

Warranty coverage begins on the date of original purchase. In the case of new home construction, warranty coverage begins on the date of first occupancy of the dwelling or six months after the sale of the product by an independent, authorized HHT dealer/distributor, whichever occurs earlier. The warranty shall commence no later than 24 months following the date of product shipment from HHT, regardless of the installation or occupancy date. The warranty period for parts and labor for covered components is produced in the following table.

Warranty Period		Heatilator ECO-CHOICE Appliances		Components Covered
Parts	Labor	Pellet	EPA Wood	
1 year		X	X	All parts and material except as covered by Conditions, Exclusions, and Limitations listed
3 years		X		Firepots and burnpots
3 years	1 year	X	X	Castings
5 years	3 years		X	Manifold tubes
5 years	3 years	X	X	Firebox and heat exchanger
90 days		X	X	All replacement parts beyond warranty period

See conditions, exclusions, and limitations on next page

**WARRANTY COVERAGE:**

- This warranty only covers HHT appliances that are purchased through an HHT authorized dealer or distributor. A list of HHT authorized dealers is available on the HHT branded websites.
- This warranty is only valid while the HHT appliance remains at the site of original installation.
- Contact your installing dealer for warranty service. If the installing dealer is unable to provide necessary parts, contact the nearest HHT authorized dealer or supplier. Additional service fees may apply if you are seeking warranty service from a dealer other than the dealer from whom you originally purchased the product.
- Check with your dealer in advance for any costs to you when arranging a warranty call. Travel and shipping charges for parts are not covered by this warranty.

**WARRANTY EXCLUSIONS:**

This warranty does not cover the following:

- Changes in surface finishes as a result of normal use. As a heating appliance, some changes in color of interior and exterior surface finishes may occur. This is not a flaw and is not covered under warranty.
- Damage to printed, plated, or enameled surfaces caused by fingerprints, accidents, misuse, scratches, melted items, or other external sources and residues left on the plated surfaces from the use of abrasive cleaners or polishes.
- Repair or replacement of parts that are subject to normal wear and tear during the warranty period. These parts include: paint, wood, pellet and coal gaskets; firebricks; grates; flame guides; light bulbs; batteries and the discoloration of glass.
- Minor expansion, contraction, or movement of certain parts causing noise. These conditions are normal and complaints related to this noise are not covered by this warranty.
- Damages resulting from: (1) failure to install, operate, or maintain the appliance in accordance with the installation instructions, operating instructions, and listing agent identification label furnished with the appliance; (2) failure to install the appliance in accordance with local building codes; (3) shipping or improper handling; (4) improper operation, abuse, misuse, continued operation with damaged, corroded or failed components, accident, or improperly/incorrectly performed repairs; (5) environmental conditions, inadequate ventilation, negative pressure, or drafting caused by tightly sealed constructions, insufficient make-up air supply, or handling devices such as exhaust fans or forced air furnaces or other such causes; (6) use of fuels other than those specified in the operating instructions; (7) installation or use of components not supplied with the appliance or any other components not expressly authorized and approved by HHT; (8) modification of the appliance not expressly authorized and approved by HHT in writing; and/or (9) interruptions or fluctuations of electrical power supply to the appliance.
- Non-HHT venting components, hearth components or other accessories used in conjunction with the appliance.
- Any part of a pre-existing fireplace system in which an insert or a decorative gas appliance is installed.
- HHT's obligation under this warranty does not extend to the appliances' capability to heat the desired space. Information is provided to assist the consumer and the dealer in selecting the proper appliance for the application. Consideration must be given to appliance location and configuration, environmental conditions, insulation and air tightness of the structure.

**This warranty is void if:**

- The appliance has been over-fired or operated in atmospheres contaminated by chlorine, fluorine, or other damaging chemicals. Overfiring can be identified by, but not limited to, warped plates or tubes, rust colored cast iron, bubbling, cracking and discoloration of steel or enamel finishes.
- The appliance is subjected to prolonged periods of dampness or condensation.
- There is any damage to the appliance or other components due to water or weather damage which is the result of, but not limited to improper chimney or venting installation.

**WARRANTY EXCLUSIONS:**

- The owner's exclusive remedy and HHT's sole obligation under this warranty, under any other warranty, express or implied, or in contract, tort or otherwise, shall be limited to replacement, repair, or refund, as specified above. In no event will HHT be liable for any incidental or consequential damages caused by defects in the appliance. Some states do not allow exclusions or limitation of incidental or consequential damages, so these limitations may not apply to you. This warranty gives you specific rights; you may also have other rights, which vary from state to state. EXCEPT TO THE EXTENT PROVIDED BY LAW, HHT MAKES NO EXPRESS WARRANTIES OTHER THAN THE WARRANTY SPECIFIED HEREIN. THE DURATION OF ANY IMPLIED WARRANTY IS LIMITED TO DURATION OF THE EXPRESSED WARRANTY SPECIFIED ABOVE.

C. Quick Start Guide

**ECO CHOICE QUICK START GUIDE**

**\*Before you plug in this appliance, follow these instructions\***

Remove hang tags from the door glass. Clean the glass. Remove the hardware pack and dessicant bag from the firebox area before your first fire.

Turn the thermostat to off.

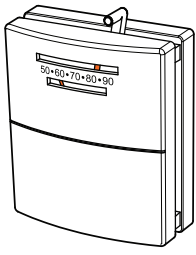

**1**

Add pellets to the hopper and close the lid.

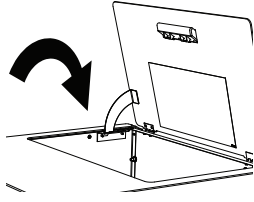

**2**

Open the firebox door and make sure the baffles are in place.



**3**

If the feed tube is empty or this is the first fire, add a handful of pellets to the firepot.

\*Do not add extra fuel to the firepot if the feed tube has already been primed. Overfilling the firepot will cause smoky start-ups.

**4**

Close the firebox door and plug the power cord into the wall receptacle.

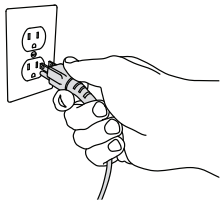

**5**

Turn the thermostat on.

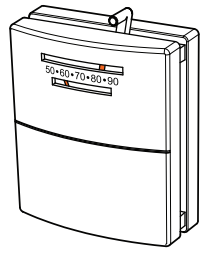

**6**

The stove will feed pellets for a minute and stop. Once a fire starts, the feed cycle will resume.

**Note:** Allow 5 minutes for ignition to take place.

**7**

If the fire dies out after a few minutes of operation it will be necessary to push the reset button to add more fuel.

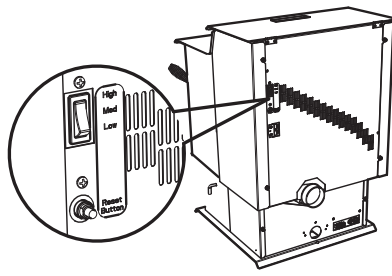

**8**

Once a fire has been established in the unit, leave the unit burning on the "high" setting for 30 minutes to allow the paint to cure.

**Note:** Odors and vapors will be released during this process.

\*Open windows in the room for ventilation\*

**9**

After 30 minutes have passed, turn the thermostat off and allow the unit to cool completely. Open the door and clean the firepot according to the cleaning instructions found inside the hopper lid or owners manual. Close the door and set the thermostat to a desired temperature. Unit is now ready to resume normal operation.

**10**

# 1 Listing and Code Approvals

## A. Appliance Certification

<b>Model</b>	ECO-ADV-PS35, ECO-ADV-PS50 and ECO-CAB50
<b>Laboratory</b>	Intertek
<b>Report No.</b>	4001508
<b>Type</b>	Solid Fuel Room Heater/Pellet Fuel Burning Type
<b>Standard</b>	ASTM E1509-04 and ULC S627-00, ULC/ORD-C1482-M1990 Room Heater Pellet Fuel Burning type and (UM) 84-HUD, Mobile Home Approved.
<b>FCC</b>	Complies with Part 15 of FCC Rules. Operation is subject to the following two conditions: (1) this device may not cause harmful interference, and (2) this device must accept any interference received, including interference that may cause undesired operation.

## B. BTU & Efficiency Specifications

	PS35	PS50 CAB50	
<b>EPA Certification #:</b>	937-14	938-14	
<b>EPA Certified Emissions:</b>	2.1	1.7	grams/hour
<b>*LHV Tested Efficiency:</b>	N/A	N/A	%
<b>**HHV Tested Efficiency:</b>	N/A	N/A	%
<b>***EPA BTU Output:</b>	9,300 to 24,400	11,900 to 31,400	per hr.
<b>****BTU Input:</b>	12,900 to 34,400	16,300 to 43,000	per hr.
<b>Vent Size:</b>	3 or 4 inches, "L" or "PL"		
<b>Hopper Capacity:</b>	45	83/120	lbs.
<b>Fuel</b>	Wood Pellets		
* Weighted average LHV efficiency using data collected during EPA emissions test.			
**Weighted average HHV efficiency using data collected during EPA emissions test.			
***A range of BTU outputs based on EPA Default Efficiency and the burn rates from the low and high EPA tests.			
****Based on the maximum feed rate per hour multiplied by approximately 8600 BTU's which is the average BTU's from a pound of pellets.			

**NOTICE:** This installation must conform with local codes. In the absence of local codes you must comply with the **ASTM E1509-04, ULC S627-00, (UM) 84-HUD and ULC/ORD-C-1482.**

The Heatilator ECO Choice Pellet Heater meets the U.S. Environmental Protection Agency's emission limits for pellet heaters sold after May 15, 2015.

This pellet heater needs periodic inspection and repair for proper operation. It is against federal regulations to operate this pellet heater in a manner inconsistent with operating instructions in this manual.

## HEATILATOR ECO CHOICE

### C. Glass Specifications

This appliance is equipped with 5mm ceramic glass. Replace glass only with 5mm ceramic glass. Please contact your dealer for replacement glass.

### D. Electrical Rating (on high)

<b>Model PS35:</b>	115 VAC, 60 Hz, Start 3.8 Amps, Run 1.3 Amps
<b>Model PS50:</b>	115 VAC, 60 Hz, Start 5.1 Amps, Run 3.0 Amps
<b>Model CAB50:</b>	115 VAC, 60 Hz, Start 5.1 Amps, Run 3.0 Amps

### E. Mobile Home Approved

- This appliance is approved for mobile home installations when not installed in a sleeping room and when an outside combustion air inlet is provided.
- The structural integrity of the mobile home floor, ceiling, and walls must be maintained.
- The appliance must be properly grounded to the frame of the mobile home with #8 copper ground wire, and use only listed double-wall connector pipe.
- Outside Air Kit, part 811-0872 or OAK-3 must be installed in a mobile home installation.
- Appliance must be secured to mobile home structure.

### F. Sleeping Room

When installed in a sleeping room it is recommended that 3ft of vertical be installed prior to horizontally exiting the room and a smoke/CO alarm be installed in the bedroom; The size of the room must be at least 50ft<sup>3</sup> per 1,000 Btu/hr stove input, if the stove exceeds the room size, out air must be installed.

### G. California - Prop65



#### WARNING

This product and the fuels used to operate this product (wood), and the products of combustion of such fuels, can expose you to chemicals including carbon black, which is known to the State of California to cause cancer, and carbon monoxide, which is known to the State of California to cause birth defects or other reproductive harm. For more information go to: [WWW.P65Warnings.ca.gov](http://WWW.P65Warnings.ca.gov)



#### WARNING



#### Fire Risk

Hearth & Home Technologies disclaims any responsibility for, and the warranty will be voided by, the following actions:

- Installation and use of any damaged appliance.
  - Modification of the appliance.
  - Installation other than as instructed by Hearth & Home Technologies.
  - Installation and/or use of any component part not approved by Hearth & Home Technologies.
  - Operating appliance without fully assembling all components.
  - Operating appliance without legs attached (if supplied with appliance).
  - Do NOT Over fire - If appliance or chimney connector glows, you are over firing.
- Any such action that may cause a fire hazard.

Improper installation, adjustment, alteration, service or maintenance can cause injury or property damage.

For assistance or additional information, consult a qualified installer, service agency or your dealer.

**NOTE:** Hearth & Home Technologies, manufacturer of this appliance, reserves the right to alter its products, their specifications and/or price without notice.

Hearth & Home Technologies WILL NOT warranty appliances that exhibit evidence of over-firing. Evidence of over-firing includes, but is not limited to:

- Warped air tube
- Deteriorated refractory brick retainers
- Deteriorated baffle and other interior components



# User Guide

## 2 Operating Instructions

### WARNING



#### Fire Risk.

- Do not operate appliance before reading and understanding operating instructions.
- Failure to operate appliance properly may cause a house fire.

Visit <http://www.heatilator.com/Shopping-Tools/Videos> to view product and use & care videos.

### A. Fire Safety

To provide reasonable fire safety, the following should be given serious consideration:

- Install at least one smoke detector and CO monitor on each floor of your home.
- Locate detectors away from the heating appliance and close to the sleeping areas.
- Follow the detector's manufacturer's placement and installation instructions and maintain regularly.
- A CO detector should be installed in the room with the appliance.
- Conveniently locate a Class A fire extinguisher to contend with small fires.
- In the event of a hopper fire:
  - Evacuate the house immediately.
  - Notify fire department.

### B. Non-Combustible Materials

Material which will not ignite and burn, composed of any combination of the following:

- |           |         |            |         |
|-----------|---------|------------|---------|
| - Steel   | - Brick | - Concrete | - Glass |
| - Plaster | - Iron  | - Tile     | - Slate |

Materials reported as passing **ASTM E 136, Standard Test Method for Behavior of Metals, in a Vertical Tube Furnace of 750° C.**

### C. Combustible Materials

Material made of/or surfaced with any of the following materials:

- |                    |                        |
|--------------------|------------------------|
| - Wood             | - Plastic              |
| - Compressed Paper | - Plywood/OSB          |
| - Plant Fibers     | - Sheet Rock (drywall) |

Any material that can ignite and burn: flame proofed or not, plastered or non-plastered.

### D. Fuel Material and Fuel Storage

Pellet fuel quality can greatly fluctuate. This appliance has been designed to burn a wide variety of fuels, giving you the choice to use the fuel that is most economical in your region.

Hearth & Home Technologies strongly recommends only using Pellet Fuel Institute (PFI) certified fuel.

### Fuel Material

- Made from sawdust or wood by-products
- Depending on the source material it may have a high or low ash content.

### Higher Ash Content Material

- Hardwoods with a high mineral content
- Fuel that contains bark
- Standard grade pellets, high ash pellets,

### Lower Ash Content Material

- Softwoods
- Fuels with low mineral content
- Premium grade pellets

### CAUTION

**Do not burn fuel that contains an additive; (such as soybean oil).**

- May cause hopper fires
- Damage to product may result

Read the ingredients list on the package. If you are buying corn the only ingredient that should be listed is corn.

### Clinkers

Minerals and other non-combustible materials such as sand will turn into a hard, glass-like substance called a clinker when heated in the firepot.

Trees from different areas will vary in mineral content. That is why some fuels produce more clinkers than others.

### Moisture

Always burn dry fuel. Burning fuel with high moisture content takes heat from the fuel and tends to cool the appliance, robbing heat from your home. Damp pellet fuel can clog the feed system.

### Size

- Pellets are either 1/4 inch or 5/16 inch (6-8mm) in diameter
- Length should be no more than 1-1/2 inches (38mm)
- Pellet lengths can vary from lot to lot from the same manufacturer
- Due to length variations, the flame height (feed rate) may need adjusting occasionally. See page 10 for instructions.

### Performance

- Higher ash content requires the ash drawer to be emptied more frequently
- Hardwoods require more air to burn properly
- Set wall control to “Utility Pellet” if the firepot and ash pan are filling quickly. This will cause the auto-clean system to empty the firepot more often.
- Premium wood pellets produce the highest heat output.
- Burning pellets longer than 1-1/2 inches (38mm) can cause an inconsistent fuel feed rate and/or missed ignitions.

We recommend that you buy fuel in multi-ton lots whenever possible. However, we do recommend trying various brands before purchasing multi-ton lots to ensure your satisfaction.

### Changing to Different Fuel Type

- Empty the hopper of the previous fuel
- Thoroughly vacuum hopper before filling with the new fuel
- Select the appropriate setting on the FUEL SELECTION screen on the thermostat wall control

The burn rate, BTU content and heat output will all vary depending on the fuel selected.



### CAUTION

Tested and approved for wood pellets. Burning of any other type of fuel voids your warranty.

### Storage

- Wood pellets should be left in their original sealed bag until using to prevent moisture absorption.
- This will also prevent rodents from becoming a problem.
- Do not store any pellet fuel within the clearance requirements or in an area that would hinder routine cleaning and maintenance.

## E. General Operating Information

### 1. Thermostat Calls For Heat

The appliance is like most modern furnaces; when the thermostat calls for heat, your appliance will automatically light and deliver heat. When the room is up to temperature and the thermostat is satisfied, the red call light will shut off and the appliance will shut down. The red call light is located behind the left access panel.

### 2. Heat Output Controls

This appliance is equipped with a heat output control switch that has three settings or burn rates; low, medium and high (**Figure 10.1**). The appliance will turn on and off as the thermostat demands. When the thermostat calls for heat, the appliance will always start up on High. After burning approximately 4 minutes, the appliance will then burn at the rate at which it was originally set. If the appliance is set at one of the lower settings, it will run quieter but takes longer to heat up an area than if it were set at a higher burn rate. Regardless of the burn rate, when the area is warm enough to satisfy the thermostat, the appliance will shut off.

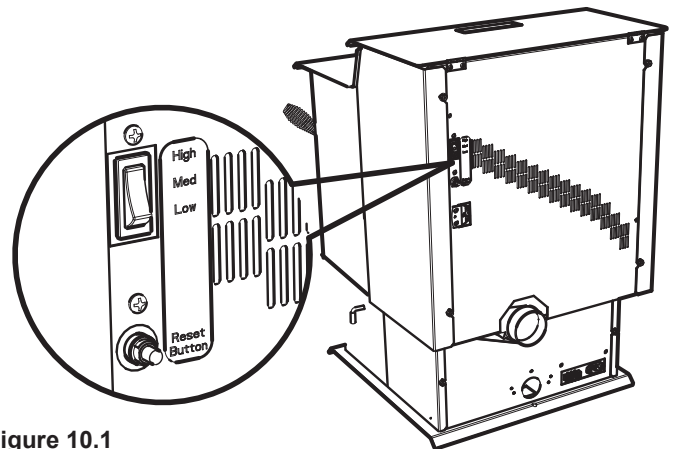

Figure 10.1

## F. Before Your First Fire

1. First, make sure your appliance has been properly installed and that all safety requirements have been met. Pay particular attention to the fire protection, venting and thermostat installation instructions.
2. Double check that the ash drawer and firebox are empty!
3. Check that cleaning rod is in the fully closed position.
4. Close and latch the door.

### CAUTION

Tip of thermocouple must be in contact with the inside end of the thermocouple cover.  
Missed ignitions can occur.

### CAUTION

HOT WHILE IN OPERATION. KEEP CHILDREN, CLOTHING AND FURNITURE AWAY. CONTACT MAY CAUSE SKIN BURNS.

## G. Hopper Lid Latch and Hopper Switch

1. Lift up the hopper lid and lock into open position. Now you can fill the hopper with fuel.
2. The hopper lid is designed to shut down the feed motor when the hopper lid is open. Leaving the lid open too long can cause the fire to go out (**Figure 11.1**).
3. To close the hopper lid, while holding lid open with one hand, push the bottom of the latch inwards to release from locked position and then slowly close the hopper lid (**Figure 11.2**).

**NOTE:** The CAB50 has no hopper lid latch. The hopper switch is located in a similar location and is activated by a magnet attached to the Hopper Lid.

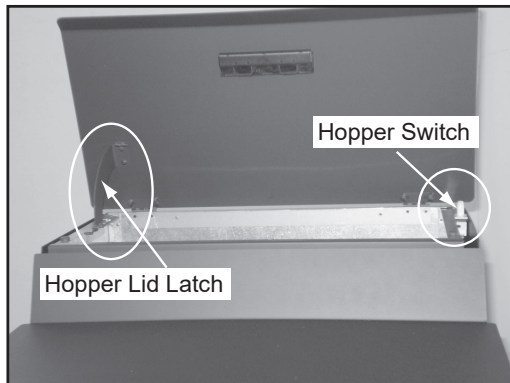

Figure 9.1

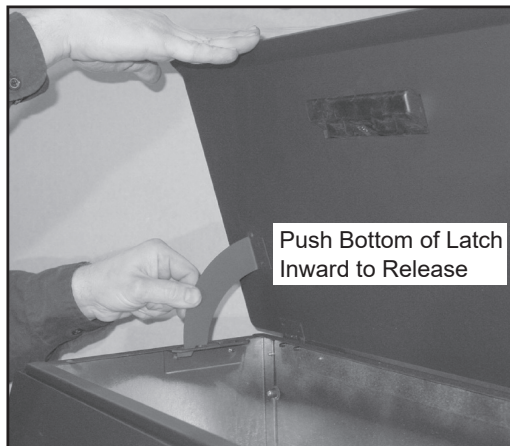

Figure 9.2

## H. Starting Your First Fire

1. A thermostat is required for proper operation of this appliance. If you have to adjust the feed rate after you have started the fire, most of the pellets in the hopper will need to be removed so start out with filling the hopper approximately 1/4 full at this time. Set the thermostat to its lowest setting and plug the power cord into nearby outlet.
2. The exhaust blower will stay on for approximately 18 minutes even though the thermostat is not calling for heat. This is normal.
3. Locate the heat output control switch mounted on the back of the appliance in the upper left corner. Figure 8.1 on page 8.
4. Turn it to the "high" setting by pushing the top of the control switch in and then adjust the thermostat to its highest setting.

5. Look through the hole in the left lower side panel and you will see the red call light on the control box will be on (**Figure 11.3**). This indicates the thermostat is calling for heat. On the CAB50 the light can be viewed from behind through the hole near the bottom left side of the rear panel.
6. The fuel feed system and the igniter should now be on.
7. For your first fire it will be necessary to press the reset button once approximately 2 minutes after start up and again in 5 minutes. Reset as needed or every 60 seconds until pellets begin to drop into firepot. This will fill the feed system and allow the appliance to begin dropping pellets. Or you can put a handful of pellets in the firepot to speed up the process. The appliance will continue to run as long as the thermostat is calling for heat.
8. Once the appliance has ignited, let it burn for approximately 15 minutes, then set the thermostat to the desired room temperature. Adjust the heat output control switch to the desired setting.



## CAUTION

Odors and vapors released during initial operation.

- Curing of high temperature paint.
- Open windows for air circulation.

Odors may be irritating to sensitive individuals.

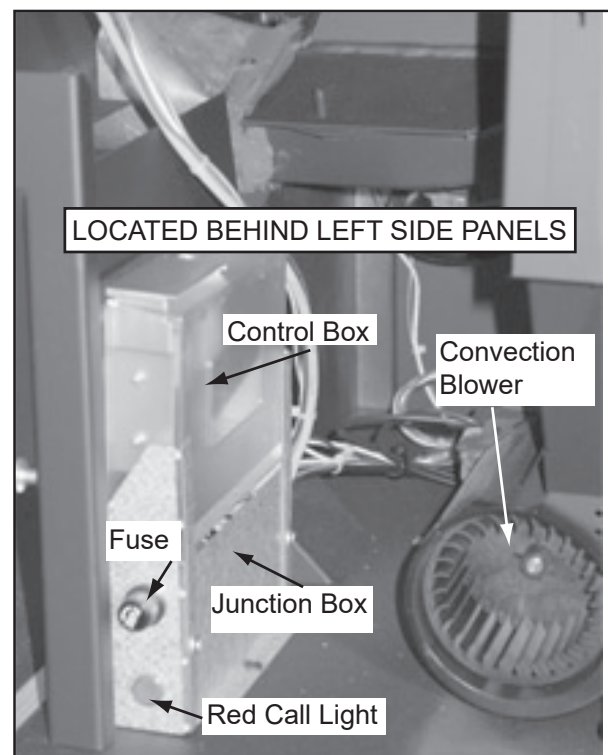

Figure 11.3

**I. Fire Characteristics**

A properly adjusted fire with the heat output control switch set on “high” has a short active flame pattern that extends out of the firepot approximately 4 to 8 inches (102 to 203mm).

If the fire has tall flames with black tails and seems somewhat lazy, the feed rate will need to be reduced. This is done by sliding the fuel adjustment control rod down, which will reduce the feed (Figure 12.1).

If the fire is not 4 to 8 inches (102 to 203mm) tall, slide the fuel adjustment control rod up to increase the feed. A medium and low setting will give a shorter flame. The flame will rise and fall somewhat. This is normal.

**J. Feed Rate Adjustment Instructions**

1. Loosen the thumb screw.
2. Pull the feed adjustment control rod up to increase the feed rate and flame height or push down to decrease the feed rate and flame height.
3. Re-tighten the thumb screw. A new stove has a break in period. The fire characteristics should be checked again after 5 bags of pellets and adjustments made if necessary.

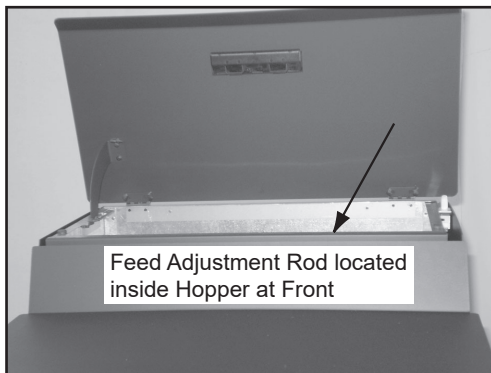

Figure 12.1

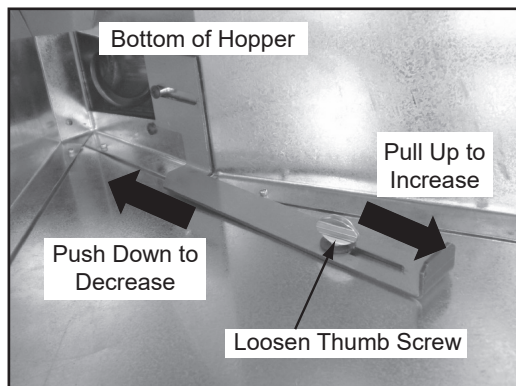

Figure 12.2

**K. Ignition Cycles**

1. At the beginning of each ignition cycle, it is normal to see some smoke in the firebox. The smoke will stop once the fire starts.

2. The convection blower will automatically turn on after your appliance has been burning for approximately 10 minutes.  
This blower transfers heat from your appliance into the room, and will continue to run after the thermostat has stopped calling for heat until the appliance has cooled down.
3. Occasionally the appliance may run out of fuel and shut itself down. When this happens, the red call light will be on (See Figure 9.3, page 9).
  - To restart it, fill the hopper and press the reset button. When you press the reset button the red call light will go out. Release the button and the light will come back on. Continue pushing the button once a minute until pellets begin to fall into the firepot.
  - You should see a fire shortly. If not, follow the instructions on page 9, for “Starting Your First Fire”.

**L. Clear Space**

**Mantel:** Avoid placing candles and other heat-sensitive objects on mantel or hearth. Heat may damage these objects.

**NOTICE:** Clearances may only be reduced by means approved by the regulatory authority having jurisdiction.

 **WARNING**



**Fire Risk.**

Do NOT place combustible objects in front of the appliance. High temperatures may ignite clothing, furniture or draperies. Maintain a minimum clearance of 3 feet (914mm) in front of appliance.

 **WARNING**



**Fire Risk.**

Keep combustible materials, gasoline and other flammable vapors and liquids clear of appliance.

- Do NOT store flammable materials in the appliance’s vicinity.
- **DO NOT USE GASOLINE, LANTERN FUEL, KEROSENE, CHARCOAL LIGHTER FLUID OR SIMILAR LIQUIDS TO START OR “FRESHEN UP” A FIRE IN THIS Appliance.**
- **DO NOT BURN GARBAGE OR FLAMMABLE FLUIDS SUCH AS GASOLINE, NAPHTHA OR ENGINE OIL.**
- **DO NOT USE CHEMICALS OR FLUIDS TO START THE FIRE.**
- Keep all such liquids well away from the appliance while it is in use.
- Combustible materials may ignite.

## M. Thermostat Operation

There is a 4 screw terminal block located on the back lower left corner of the stove directly above the power cord inlet. The center 2 screws are for the thermostat wires (see Figure 11.1 on page 11).

The appliance comes standard with a wall thermostat and 25' of wire. If you need to run more than 25' make sure you use a continuous strand of 18 to 22 gauge thermostat wire. For optimum performance your thermostat should be located on an inside wall approximately 5' up from the floor.

### How to Install Your Wall Thermostat

1. Separate the body of the thermostat from the mounting plate by gently pulling the two pieces apart
2. Connect your thermostat wire to the W and R terminals (see Figure 11.2 on page 11)
3. Screw the backer plate to the wall using the hardware included.
4. Snap the thermostat to the backer plate
5. Connect the wires to the 2 center screws on the terminal block on the back of the product

### Battery Installation and Replacement

NOTE: 2 AA batteries are included with the thermostat and must be installed before the appliance can be operated (see Figure 11.3 on page 11).

Install fresh batteries immediately when the REPLACE BATTERY warning begins flashing. The warning flashes about two months before the batteries are depleted. Even if the warning does not appear, you should replace batteries once a year.

If batteries are inserted within two minutes, the time and day will not have to be reset. All other settings are permanently stored in memory.



### CAUTION



Shock hazard.

- Do NOT remove grounding prong from plug.
- Plug directly into properly grounded 3 prong receptacle.
- Route cord away from appliance.
- Do NOT route cord under or in front of appliance.

## N. Frequently Asked Questions

### What causes my glass to become dirty?

If the glass has white ash build up it is normal and the glass should be cleaned. If it is a black soot build up airflow through the unit may be restricted. The most often cause is overdue maintenance and cleaning. See "Maintaining and Servicing Appliance" in the owner's manual.

### How can I get more heat out of the appliance?

The most often cause of diminished heat output is overdue maintenance and cleaning. See "Maintaining and Servicing Appliance" in the owner's manual. If this still does not help, verify the correct settings for maximum heat output. See "Feed Rate Adjustment" under "Operating Instructions" in the owner's manual.

### What should I do if I smell smoke or there is ash/soot coming from the appliance?

While there will always be some smoke smell from wood burning appliances (including pellet) you should investigate all venting to make sure it is sealed properly. Most venting requires silicone to seal the seams. In addition most homes are built very tight today and with exhaust systems can create negative pressure in the home. See "Negative Pressure" under "Getting Started" in the owner's manual if you have checked the venting but still have smoke coming from the appliance. For ash or soot check the above and the exhaust blower housing and seals.

### Why would my appliance run fine last winter but not start this fall?

It is possible that the stove was not properly prepared for the Non-burn season. See "Trouble shooting" in the owner's manual.

### Why would the metal on the inside of the appliance begin to flake?

There are some pellet mills that get their raw materials from lumber mills that purchase logs that are transported in sea water. These pellets can have a higher salt content and cause the metals in the unit to corrode prematurely and deteriorate. If you are seeing any components inside the firebox deteriorate it is recommended to change pellet brands immediately.

### Why does only the exhaust blower run when I unplug and plug back in my appliance?

This is a Safety feature to prevent the unit from operating in an unsafe condition. Allow the unit to run and it will return to normal operation.

### Is there a place to lubricate the blowers to quiet them down?

The most often cause of noisy blowers is from the impellers becoming dirty over time. See "General Maintenance & Cleaning" under "Maintaining & Servicing Appliance" in the owner's manual. No form of lubrication should ever need applied to the blowers.

### Why are different components cycling on and off in my appliance at random?

The selector switch on control box may be on the wrong setting. Refer to the Reference Materials section of our owner's manual for details.

## HEATILATOR ECO CHOICE

---

### **What is the metal object with the bend in it for that came inside the plastic bag?**

It is a clean-out tool used to help clean the fire pot and remove any jams in the rare event they occur in the feed tube.

### **Why is there a black residue building up on the outside of my home?**

Wind can cause this to happen. If the appliance is operating correctly very little soot should ever exit the termination cap. Also check to be sure the venting is installed per the owner's manual and local codes.

### **Do I need an outside air kit?**

Outside air is required for mobile home installs and in some jurisdictions. Refer to "Listing & Code Approvals", "Mobile Home Installation" and "Appliance Set-up" owner's manual. Also refer to local building codes.

### **I am seeing sparks coming out of my pipe (termination cap) outside is this safe?**

This is normal. As long as clearances to combustibles were followed this is safe.

### **My unit sounds like a freight train at times what can be done to eliminate this?**

This is referred to as Rumbling. Maintenance may be needed see "Maintaining and Servicing appliance" in the owner's manual. Decrease fuel flow see "Feed rate adjustment" under Operating Instructions".

### **Why does my unit run fine on high, but shuts down on low and medium?**

Maintenance may be needed see "Maintaining and Servicing Appliance" See also "Trouble Shooting".

### **Can I use another brand of wall thermostat or remote system?**

Yes, any remote/wall thermostat system that does not require power from the appliance should work.

### **I have no power to anything. Does this unit have a circuit breaker or fuse or a reset button?**

This unit has one serviceable fuse in the junction box and a reset button for the thermostat circuit.

### **Can I burn corn in my unit?**

Corn is not an approved fuel for the ECO units.

### **I'm thinking about going green (solar power) and need to know what the power consumption is on my Unit.**

PS50 115 VAC, 60 Hz, Start 5.1 Amps, Run 3.0 Amps.  
PS35 115 VAC, 60 Hz, Start 3.8 Amps, Run 1.3 Amps.  
CAB50 115 VAC, 60 Hz, Start 5.1 Amps, Run 3.0 Amps

### **Where is the serial # of my unit is located?**

The serial # is located on the back of the stove.

CONTACT YOUR DEALER for additional information regarding operation and troubleshooting.  
Visit [www.heatilator.com](http://www.heatilator.com) to find a dealer.

# 3 Maintenance and Service

When properly maintained, your fireplace will give you many years of trouble-free service. Contact your dealer to answer question regarding proper operation, troubleshooting and service for your appliance. Visit [www.heatilator.com/Owner-Support](http://www.heatilator.com/Owner-Support) to view basic troubleshooting, FAQs, use & care videos. We recommend annual service by a qualified service technician.

## A. Proper Shutdown Procedure

Turn off the thermostat.

This pellet heater has a manufacturer-set minimum low burn rate that must not be altered. It is against federal regulations to alter this setting or otherwise operate this pellet heater in a manner inconsistent with operating instructions in this manual.

**Follow the detailed instructions found in this section for each step listed as referenced in the chart below.**

## B. Quick Reference Maintenance Chart

Cleaning or Inspection	Frequency		Daily	Weekly	Every 2 Weeks	Monthly	Yearly
Ash Pan - Burning Wood Pellets	Every 5 bags of fuel	OR		X			
Ash Pan - Burning Alternate Fuels	Every 1 bag of fuel	OR	X				
Ash Removal from Firebox	More frequently depending on the fuel type or ash build-up	OR		X			
Blower, Combustion (Exhaust)	More frequently depending on the fuel type	OR					X
Blower, Convection	More frequently depending on the operating environment	OR					X
Door Latch Inspection	Prior to heating season	OR				X	
Firebox - Prepare for Non-Burn Season	At end of heating season	OR					X
Fire pot - Burning Softwood Pellets	Every 5 bags	OR		X			
Fire pot - Burning Hardwood Pellets	Every 3 bags	OR		X			
Glass	When clear view of fire pot becomes obscured	OR		X			
Heat Exchanger & Drop Tube	Every 1 ton of fuel	OR			X		
Hopper	Every 1 ton of fuel or when changing fuel types	OR				X	
Top Vent Adapter	More frequently depending on ash build-up	OR					X
Venting System	More frequently depending on the fuel type	OR					X

### CAUTION

#### Shock and Smoke Hazard



- Turn down thermostat, let appliance completely cool and exhaust blower must be off. Now you can unplug appliance before servicing.
- Smoke spillage into room can occur if appliance is not cool before unplugging.
- Risk of shock if appliance not unplugged before servicing appliance.

**NOTICE:** These are recommendations. Clean more frequently if you encounter heavy build-up of ash at the recommended interval or you see soot coming from the vent. **Not properly cleaning your appliance on a regular basis will void your warranty.**

**C. General Maintenance**

**1. Types of Fuel**

Depending on the type of fuel you are burning will dictate how often you have to clean your fire pot.

If the fuel you are burning has a high dirt or ash content, it may be necessary to clean the fire pot more than once a day.

Dirty fuel will cause clinkers to form in the fire pot. A clinker is formed when dirt, ash or a non-burnable substance is heated to 2000°F (1093°C) and becomes glass-like. See “D” page 17 in this section for more details on fuels with high ash content.

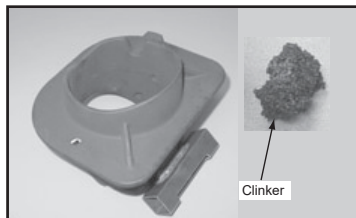

Figure 16.1 - Clinker

**2. Cleaning Firepot with Cleaning Rod & Firepot Clean-Out Tool:**

- **Frequency:** Daily or more often as needed
- **By:** Homeowner
  - a. The appliance must be in complete shutdown and cool and the exhaust blower off. If you are just cleaning the firepot, there is no need to unplug the appliance.
  - b. Locate the firepot cleaning rod on the right side of the appliance (**Figure 16.2**). When you pull the cleaning rod straight out it will slide open the firepot floor to allow the ashes to be deposited in the ash drawer. You will see the light color painted area on the cleaning rod to let you know the rod is in OPEN position (**Figure 16.3**).
  - c. Pull the firepot cleaning rod OUT and IN a couple of times to help shake debris loose. If the rod is hard to pull, it may be necessary to use your firepot clean-out tool to chip away material that has built up on the bottom plate of the firepot and to push out any clinkers while in the open position.
  - d. To close the firepot floor: slightly raise the cleaning rod and then push it back into place. If you have closed the cleaning rod properly (pushed all the way in) you will not see any of the light color painted area (**Figure 16.3**).
  - e. Always have the ash drawer in place before pulling the firepot cleaning rod, otherwise the ashes will fall down and fill the outside air opening and the appliance will produce soot out of the exhaust and will affect efficiency.

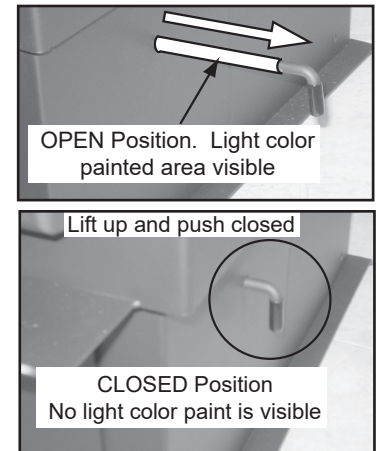
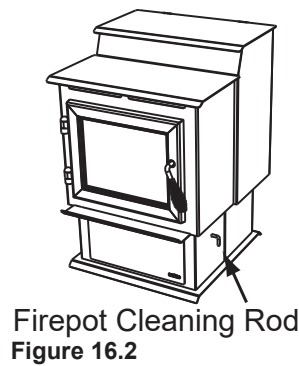



Figure 16.3

 <b>WARNING</b>	
	<p><b>Fire Risk</b></p> <ul style="list-style-type: none"> <li>• NEVER pull firepot cleaning rod out when appliance is operating.</li> <li>• Cleaning Rod <b>MUST</b> be completely pushed in before operating appliance.</li> <li>• Hot pellets may fall into ash pan and start a fire or mis-starts due to lack of vacuum.</li> </ul>

**3. Ash Removal from Firebox**

- **Frequency:** Weekly or more frequently depending on ash build-up.
- **By:** Homeowner
  - a. There must not be any hot ashes in the firebox during cleaning so allow the appliance to completely cool. The firebox ash should be removed every time the exhaust path is cleaned. Frequent cleaning of the ash in the firebox will help slow down the build-up of ash in the exhaust blower and vent system.
  - b. Vacuum out the firebox thoroughly on both sides of the firebox and the floor and ceiling. The ash drawer should be emptied every time you clean the firebox. Remember to place the ash and debris into a metal or non-combustible container. See Disposal of Ashes (Pg 15).
  - c. Always have the ash drawer in place before pulling the firepot cleaning rod, otherwise the ashes will fall down and fill the outside air opening and the appliance will produce soot out of the exhaust and will affect efficiency.

 <b>WARNING</b>	
	<p><b>Burn Risk</b></p> <ul style="list-style-type: none"> <li>• NEVER remove ash drawer while appliance is operating.</li> </ul>



**4. Cleaning Ash Drawer**

- **Frequency:** Weekly or every 5 bags of fuel
- **By:** Homeowner
  - a. There must not be any hot ashes in the ash drawer when you empty it, so allow the appliance to completely cool.
  - b. Locate the ash drawer underneath the firepot. Slide the ash drawer straight out. Empty into a non-combustible container and re-install the ash drawer. See Disposal of Ashes (Pg 15).
  - c. Always have the ash drawer in place before pulling the firepot cleaning rod, otherwise the ashes will fall down and fill the outside air opening and the appliance will produce soot out of the exhaust and will affect efficiency.

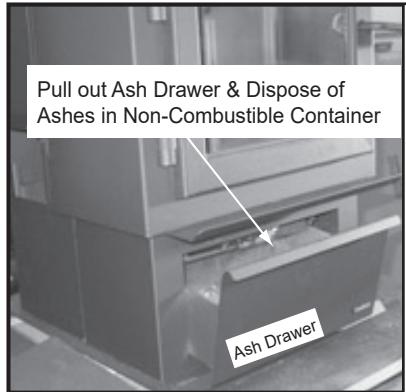

Figure 17.1

**5. Disposal of Ashes**

- **Frequency:** As needed
- **By:** Homeowner

Ashes should be placed in a metal container with a tight-fitting lid. The closed container of ashes should be placed on a non-combustible floor or on the ground, well away from all combustible materials, pending final disposal.

If the ashes are disposed of by burial in soil or otherwise locally dispersed, they should be retained in the closed container until all cinders have been thoroughly cooled.

<b style="font-size: 1.2em; margin-left: 10px;">WARNING</b>
<p><b>Disposal of Ashes</b></p> <ul style="list-style-type: none"> <li>• Ashes should be placed in metal container with tight fitting lid.</li> <li>• Ashes should be retained in closed container until all cinders have thoroughly cooled.</li> </ul>

**6. Cleaning the Exhaust Path, Baffles & Drop Tube**

- **Frequency:** Monthly or every 25 bags or more frequently depending on ash build-up.
- **By:** Homeowner
  - a. Appliance must be completely cool.
  - b. Open the door and remove the center baffle first and then the right and left baffles. See Baffle Removal Instructions on page 23. Thoroughly vacuum the exhaust path and drop tube and continue throughout the rest of the firebox. Also vacuum the front and back of the baffles.
  - c. Also vacuum the combustion blower impellers or use a soft brush to remove any ash build-up.

Replace the right and left baffles and then the center baffle and close and latch the door.

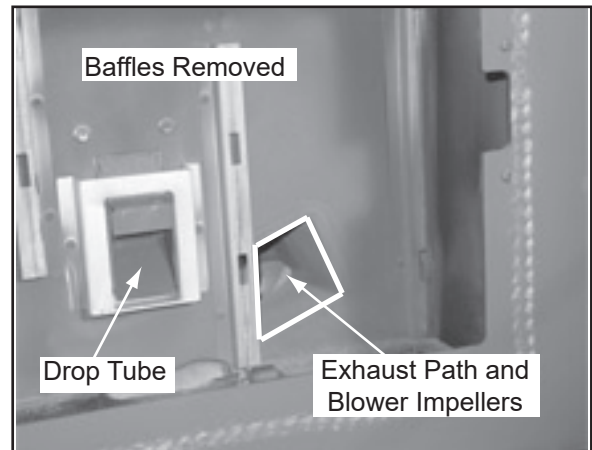

Figure 17.2

**7. Cleaning the Hopper**

- **Frequency:** Monthly or after burning 50 bags of fuel
- **By:** Homeowner

After burning approximately 50 bags of fuel you will need to clean the hopper to prevent sawdust build-up.

A combination of sawdust and pellets on the bottom end of the auger reduces the amount of fuel supply to the firepot. This can result in nuisance shutdowns and mis-starts.

- a. The appliance must be in complete shutdown. Allow the appliance to completely run out of pellets and cool down.
- b. Empty the hopper of any remaining pellets.
- c. Vacuum the hopper and feed tube.

**NOTE:** Hearth & Home Technologies recommends to use a heavy duty vacuum cleaners specifically designed for solid fuel appliance cleaning.

**8. Soot and Fly Ash: Formation & Need for Removal in Exhaust Venting System.**

- **Frequency:** Yearly or more frequently depending on ash build-up.
  - **By:** Qualified Service Technician/Homeowner
- Be sure the appliance is allowed to cool, has been unplugged and the exhaust blower is off.

The products of combustion will contain small particles of fly ash. The fly ash will collect in the exhaust venting system and restrict the flow of the flue gases.

At start-up if there is incomplete combustion, or if there is a shutdown or incorrect operation of the appliance it will lead to some soot formation. This will collect in the exhaust venting system.

The venting (chimney) system may need to be cleaned at least once a year or more often depending upon the quality of your fuel or if there are any horizontal pipe sections. Ash will build up more quickly in the horizontal sections and elbows.

**9. Door Handle Inspection**

- **Frequency:** Monthly or prior to heating season
  - **By:** Homeowner
- The gasket between the glass and firebox should be inspected periodically to make sure there is a good seal. Check door handle for smooth cam operation.

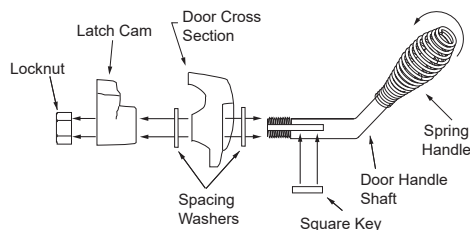

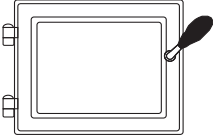

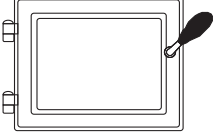

Figure 18.1

**10. Cleaning the Glass**

- **Frequency:** When clear view of the firepot becomes obscure
- **By:** Homeowner
  - a. Appliance must be completely cool before cleaning glass.
  - b. Vacuum fly ash from glass and door rope.
  - c. Use a damp paper towel or any non-abrasive glass cleaner. Wipe off with dry towel.

 <b>CAUTION</b>	
	Handle glass assembly with care.
	<b>When cleaning glass:</b> <ul style="list-style-type: none"> <li>• Avoid striking, scratching or slamming glass.</li> <li>• Do NOT clean glass when hot.</li> <li>• Do NOT use abrasive cleaners.</li> <li>• Refer to maintenance instructions.</li> </ul>

 <b>WARNING</b>	
	Handle glass with care.
	<ul style="list-style-type: none"> <li>• Inspect the gasket to ensure it is undamaged.</li> <li>• Do NOT strike, slam or scratch glass.</li> <li>• Do NOT operate appliance with glass assembly removed.</li> </ul>

**11. Cleaning Exhaust Blower - Requires No Lubrication**

- **Frequency:** Yearly or more frequently depending on ash build-up
- **By:** Homeowner or Qualified Service Technician
  - a. Be sure the appliance is allowed to cool, has been unplugged and the exhaust blower is off.
  - b. Follow the directions for cleaning the exhaust path found on page 15.
  - c. If unable to thoroughly clean the blower through this access, then follow the directions on page 22 for direct access to the exhaust blower.
  - d. Vacuum the blower's impellers. Use care not to bend or damage the blower fins.

<p>NOTE: Hearth &amp; Home Technologies recommends to use a heavy duty vacuum cleaners specifically designed for solid fuel appliance cleaning.</p>
---

## 12. Cleaning Convection Blower - Requires No Lubrication

- **Frequency:** Yearly or more frequently depending on Dust/Dirt build-up
- **By:** Homeowner or Qualified Service Technician
  - a. Be sure the appliance is allowed to cool and has been unplugged.
  - b. Follow the directions on page 21 for direct access to the convection blower.
  - c. Sweep or vacuum out any build-up. Use a brush or compressed air to loosen dirt if needed.

## 13. Cleaning the Top Vent Adapter

- **Frequency:** Yearly or more frequently depending on ash build-up
- **By:** Homeowner
  - a. The appliance must be in complete shutdown and the exhaust blower should be off. Allow the appliance to completely cool down.
  - b. Open the clean-out cover (**Figure 19.1**).
  - c. Sweep or vacuum out any ash build-up.

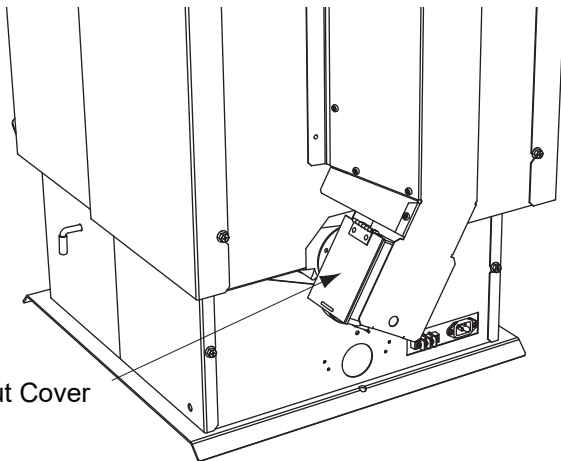

Figure 19.1

## 14. Preparing Firebox for Non-Burn Season

- **Frequency:** Yearly
- **By:** Homeowner
  - a. Be sure the appliance is allowed to cool, has been unplugged and the exhaust blower is off.
  - b. Remove all ash from the firebox and vacuum thoroughly.
  - c. Paint all exposed steel, including cast-iron.
    - Purchase paint from your local dealer.
    - Must use a high-temperature paint made specifically for heating appliances.

**D. High Ash Fuel Content Maintenance**

- **Frequency:** As needed
- **By:** Homeowner



Poor quality pellet fuel, or lack of maintenance, can create conditions that make the firepot fill quickly with ashes and clinkers.

This condition makes the appliance susceptible to overfilling the firepot with pellets which may result in smoking, sooting and possible hopper fires. **Figure 20.1** shows an example where the firepot overfills, pellets back up into the feed tube and ash has accumulated in the firebox.

An inefficient and non-economical method of burning of fuel caused by poor quality pellet fuel is shown in **Figure 20.2**.

The correct flame size when good quality, premium pellet fuel is burned is shown in **Figure 20.3**.

If the ash buildup exceeds the half way point in the firepot IMMEDIATE ATTENTION AND CLEANING IS REQUIRED.

 <b>WARNING</b>	
	<b>Fire Risk</b>
	<ul style="list-style-type: none"> <li>• High ash fuels, or lack of maintenance, can cause the firepot to overfill. Follow proper shutdown procedure if ash buildup exceeds halfway point in firepot.</li> <li>• Failure to do could result in smoking, sooting and possible hopper fires.</li> </ul>

**E. Soot or Creosote Fire**

Establish a routine for the fuel, wood burner and firing technique. Check daily for creosote build-up until experience shows how often you need to clean to be safe. Be aware that the hotter the fire the less creosote is deposited, and weekly cleaning may be necessary in the mild weather even though monthly cleaning may be enough in the coldest months. Contact your local municipal or provincial fire authority for information on how to handle a chimney fire.

**In the event of a soot or creosote fire, close the firebox door, exit the building immediately and contact the proper fire authorities.**

**DO NOT under any circumstances re-enter the building.**

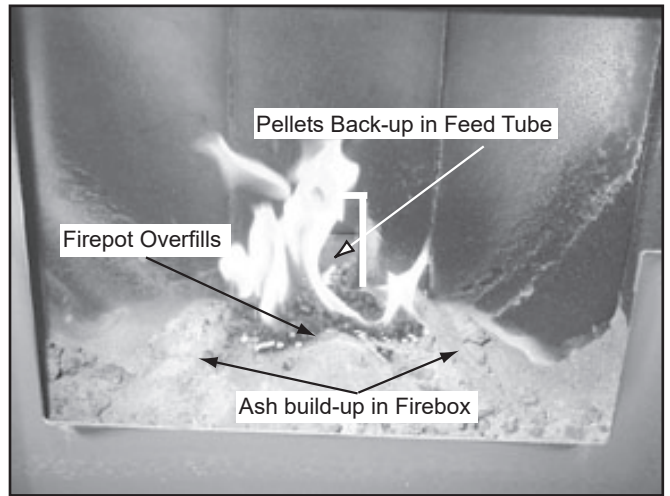

**Figure 20.1**

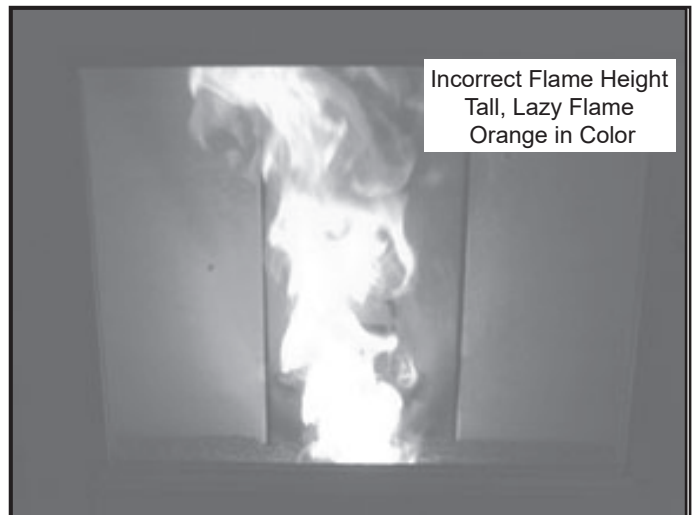

**Figure 20.2**

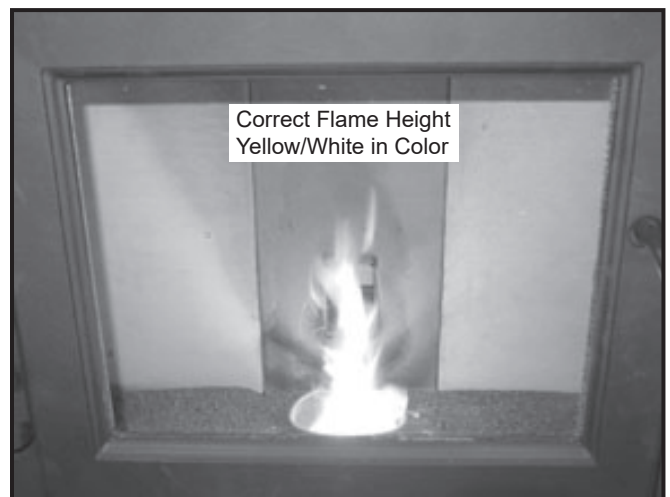

**Figure 20.3**

# 4 Troubleshooting Guide

With proper installation, operation, and maintenance your appliance will provide years of trouble-free service. If you do experience a problem, this troubleshooting guide will assist a qualified service person in the diagnosis of a problem and the corrective action to be taken. This troubleshooting guide can only be used by a qualified service technician.

Symptom	Possible Cause	Corrective Action
Plug in appliance - No response.	No current to outlet. 7 amp fuse defective. #3 snap disc tripped or defective. Control box defective.	Check circuit breaker at service panel. Replace fuse. Reset or replace snap disc. Replace control box.
Call light on. No fire. No fuel in fire pot.	Out of fuel. #2 snap disc may be defective. Vacuum switch not closing, no vacuum.  Control box defective.	Check hopper. Fill with fuel. Replace snap disc. Check exhaust blower is plugged in and operating. Check vacuum switch is plugged in. Check vacuum hose is in good condition, clear and connected at both ends. Check thermocouple is in good condition and plugged in properly. Make sure venting system is clean. Make sure front door is closed. Replace control box.
Call light on. No fire. Partially burned fuel in fire pot.	Fire pot clean-out plate not closed.  Fire pot is dirty (missed ignition).	Check that fire pot clean-out plate is fully closed. Clean fire pot. Make sure there is no clinker in the fire pot. Clinkers may have to be broken up with fire pot scraper tool or other means.
Call light on. No fire. Unburned pellets in fire pot.	Fire pot clean-out plate not closed.  Fire pot is dirty.  Ignition hole blocked.  Igniter not working.  Control box defective.	Check that fire pot clean-out plate is fully closed. Clean fire pot. Make sure there is not a clinker in the fire pot. Clinkers may have to be pushed out of fire pot with fire pot scraper tool or other means. Scrape with solid piece of wire. Remove ash pan to see if igniter is glowing red on start-up. Check igniter wires for good connection. Replace igniter using 1/4 inch male /female spade connectors. Replace control box.
Slow or smoky start-up.	Fire pot clean-out plate not closed. Fire pot is dirty.  Excessive amount of fuel at start-up.	Check that fire pot clean-out is fully closed. Clean fire pot. Make sure there is not a clinker in the fire pot. Clinkers may have to be pushed out of fire pot with fire pot scraper tool or other means. Reduce feed rate using feed rate adjustment control rod located inside hopper.

## HEATILATOR ECO CHOICE

Symptom	Possible Cause	Corrective Action
Slow or smoky start-up (Cont'd)	Dirty exhaust and/or venting system.	Check for ash build up in appliance, including behind rear panels, firebox, heat exchanger, exhaust blower and venting.
Feed system fails to start.	<p>Out of fuel. #2 snap disc may be defective.</p> <p>Vacuum switch not closing. No vacuum.</p> <p>Feed system jammed or blocked.</p> <p>Feed spring not turning with feed motor.</p> <p>Feed motor defective or not plugged in.</p>	<p>Check hopper, fill with fuel. Replace snap disc. Firebox door must be closed securely.</p> <p>Check exhaust blower is plugged in and operating. Check vacuum switch is plugged in. Check vacuum hose is in good condition, clear and connected at both ends. Check thermocouple is in good condition and plugged in properly. Make sure venting system is clean. <b>NOTE:</b> High winds blowing into the venting system can pressurize the firebox causing loss of vacuum. Empty hopper of fuel. Use a wet/dry vacuum cleaner to remove remaining fuel, from hopper, including feed tube. Check feed chute for obstructions. Loosen 2 screws and jiggle feed assembly. Check that set screw is tight on feed spring shaft at end of feed motor. Check connections on feed motor, replace if defective.</p>
No call light. Appliance does not begin start sequence.	<p>Thermostat not set to a high enough temperature. Snap Disc #3 tripped. No power. Fuse blown. Connections at thermostat and/or appliance not making proper contact. Defective thermostat or thermostat wiring.</p> <p>Control box defective.</p>	<p>Adjust thermostat above room temperature. Reset snap disc. Connect to power. Replace fuse. Check connections at thermostat and appliance. Replace thermostat or wiring. <b>NOTE:</b> To test thermostat and wiring, use a jumper wire at the thermostat block on the appliance to by-pass thermostat and wiring.</p> <p>Replace control box.</p>
Appliance fails to shut off.	Call light on.	<p>Turn thermostat off. If call light does not go out, disconnect thermostat wires from appliance. If call light does go out, thermostat or wires are defective.</p>

Symptom	Possible Cause	Corrective Action
Convection blower fails to start.	No call light. #1 snap disc defective. Blower not plugged in. Blower is defective. Control box is defective.	Defective control box. Replace snap disc. Check that blower is plugged into wire harness. Replace blower. Replace control box.
Exhaust blower fails to start or does not shut off.	Blower not plugged in. Blower is clogged with ash. Blower is defective. Control box is defective.	Check that blower is plugged into wire harness. Clean exhaust system. Replace blower. Replace control box.
Large, lazy flame, orange color. Black ash on glass.	Dirty appliance. Poor fuel quality, high ash content. Fire pot clean-out plate not completely closed. Excessive amount of fuel.	Clean appliance, including fire pot, heat exchangers and venting system. Remove stainless steel baffle from firebox to clean ash from on top of baffle. Clean behind rear brick panels. Change fuel brand to premium. Check that fire pot clean-out plate is fully closed. Reduce feed rate using feed rate adjustment control rod located inside hopper.
Nuisance shutdowns.	Low flame. Sawdust buildup in hopper. Feed motor is reversing. Defective thermocouple. Defective control box. Fire pot more than 1/2 full	Increase feed by opening feed rate adjustment control rod located inside hopper. Clean hopper, see <b>page 35</b> . Check for good connections between feed motor and wire harness. Replace thermocouple. Replace control box. See <b>page 38</b> for detailed instructions for "High Ash Fuel Content Maintenance".
Appliance calls for heat. Call light illuminates. Exhaust blower starts. No feed or igniter.	Thermocouple is defective or not properly plugged in. Defective control box	Check connections on thermocouple or replace if defective. A flashing yellow light on the control box indicates a problem with the thermocouple. Replace control box.

# 5 Service Parts Replacement

## A. Convection Blower Replacement

1. Turn down the thermostat, let appliance completely cool and then unplug appliance before servicing.
2. The convection blower is located on the floor at the rear of the appliance.
3. Lift the hopper lid up until it locks into place.
4. Loosen the 4 screws on the upper back panel and the 2 screws on the lower back panel, using a #2 Phillip Head screwdriver, a 3/8 inch wrench or a 3/8 Inch socket. You do not need to remove them (**Figure 24.1**).
5. Remove the left upper and lower side panels by lifting up and out. The hooks on the panels will slide out of the slots on the appliance (**Figure 24.2**).
6. Release blower wires from the nylon wire retainer if applicable. Model ECO-ADV-PS35 has 2 black wires and Model ECO-ADV-PS50 and ECO-CAB50 has 1 black and 1 white wire coming from the blower.
7. Remove the wing bolt and move the blower and hold-down bracket toward the back of the appliance to release the locating tab (**Figure 24.3**). Pull the blower out from under the convection plenum. Slide the blower out of the appliance. Disconnect the wires from the spade connectors at this time (**Figure 24.4**).
8. Return wires to nylon wire retainer. Make sure wires do not contact any moving parts or touch any surfaces that may become hot (**Figure 24.4**).

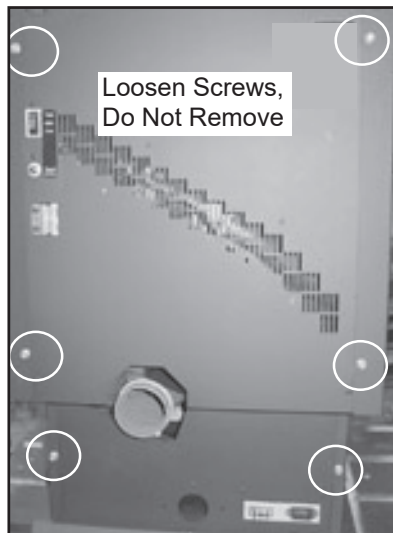

Figure 24.1

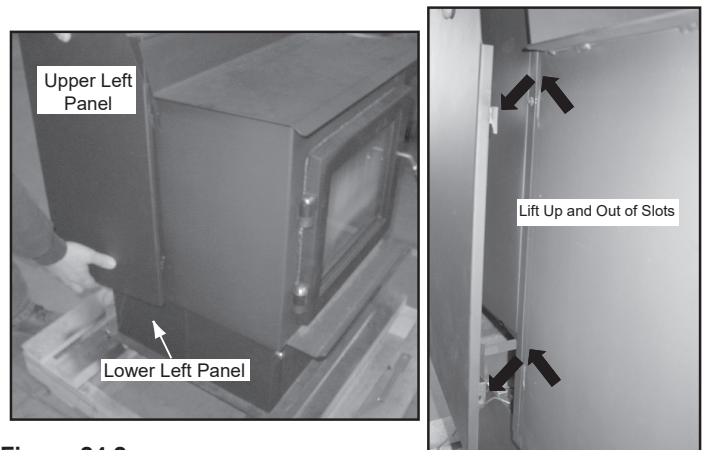

Figure 24.2

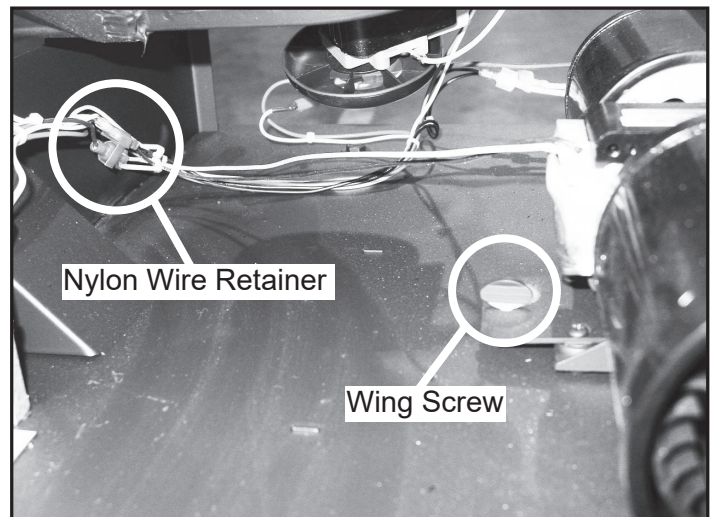

Figure 24.3

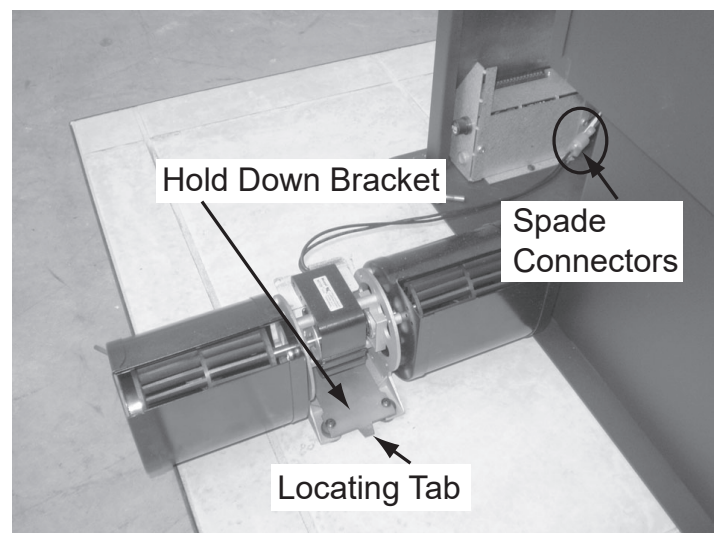

Figure 24.4



## B. Exhaust Blower Replacement

1. Turn down the thermostat, let appliance completely cool and then unplug appliance before servicing.
2. Remove both upper and lower right side curtains (**Figure 25.2**).
3. Disconnect 2 white wires from the white and blue wires of the exhaust blower.
4. There is a removable plate on the exhaust blower. Depending on the model, use a 1/4 inch socket, or 1/4 inch Nut Driver or #2 Phillips Head screw driver to loosen the 6 screws in the keyhole shaped holes and rotate the plate. It is only necessary to loosen screws (**Figure 25.1**).
5. Remove the exhaust blower and gasket.
6. Check for degradation on the gasket and replace if necessary using the gasket included in the kit.
7. Re-install in reverse order.

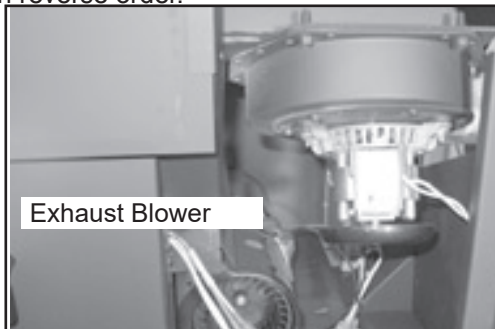

Figure 25.1

## C. Snap Disc Replacements

### Snap Disc #1 - Convection Blower

1. Turn down thermostat, let appliance cool completely if running. Then unplug appliance before servicing.
2. Using #2 Phillips screwdriver, 3/8" wrench, or 3/8" socket loosen the three screws that hold the right upper and lower side panels in place. You do not need to remove the screws. Remove side panels by lifting up and out.
3. Snap disc #1 is located on the convection plenum below the feed motor (**Figure 251**).
4. It has two purple wires attached to it with 1/4 inch female spade terminals.
5. Disconnect the two wires from the snap disc. Using a #2 Phillips screwdriver, remove the two screws securing the snap disc to the appliance.
6. Re-install in reverse.

### Snap Disc #2 - Fuel Delivery Interrupt

1. Turn down thermostat, let appliance cool completely if running. Then unplug appliance before servicing.
2. Using #2 Phillips screwdriver, 3/8" wrench, or 3/8" socket loosen the three screws that hold the right upper and lower side panels in place. You do not need to remove the screws. Remove side panels by lifting up and out.
3. Snap disc #2 is located on the convection plenum in the center of the appliance above the convection blower (**Figure 25.2**).
4. It has a black wire and an orange wire attached to it with 1/4 inch female spade terminals.
5. Disconnect the two wires from the snap disc. Using a #2 Phillips screwdriver, remove the two screws securing the snap disc to the appliance.
6. Re-install in reverse.

### Snap Disc #3 - Feed Motor - Manual Reset

1. Turn down thermostat, let appliance cool completely if running. Then unplug appliance before servicing.
2. Using #2 Phillips screwdriver, 3/8" wrench, or 3/8" socket loosen the three screws that hold the right upper and lower side panels in place. You do not need to remove the screws. Remove side panels by lifting up and out.
3. Snap disc #3 is located on the bracket on the feed tube near the feed motor (**Figure 25.1**).
4. It has two gray wires attached to it with 1/4 inch female spade terminals.
5. The locating bracket is attached to the feed tube with an 8 X 32 wing nut. Remove the wing nut to detach the bracket from the feed tube.
6. Disconnect the two wires from the snap disc.
7. Using a #2 Phillips screwdriver, remove the screw securing the snap disc to the bracket (**Figure 25.3**).
8. Re-install in reverse.

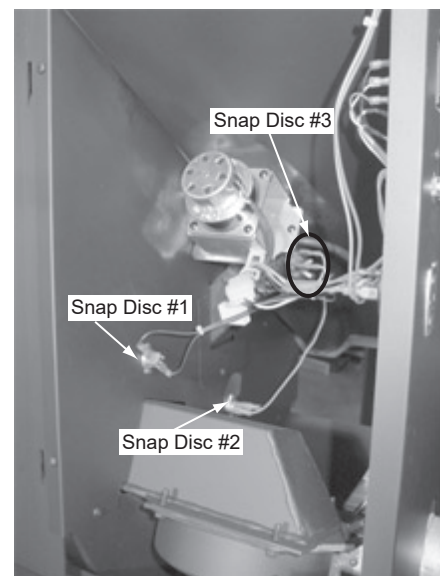

Figure 25.2

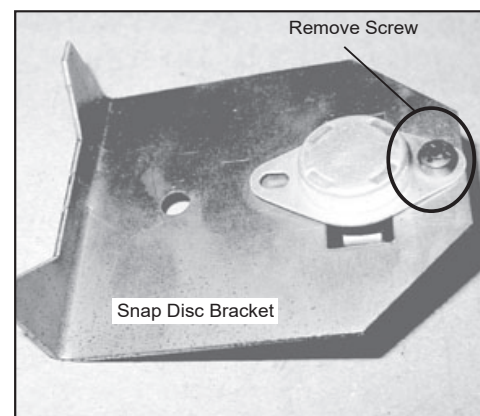

Figure 25.3

### D. Igniter Replacement

1. Shut down the appliance by turning down the thermostat and let the appliance completely cool down. After the appliance has cooled down, unplug it and remove the ash drawer.
2. The wire leads to the igniter are connected to the wire harness with 1/4 inch male / female spade connectors.
3. Follow the directions on page 21 to remove the upper and lower right side panels to expose the spade connectors.
4. Disconnect the spade connectors and remove the igniter from the chamber. Loosen thumb screw and slide igniter out.
5. Install new igniter into the chamber and tighten thumb screw. The wires MUST route through the wire retainer hook and then re-connect the wires to the 2 leads with the spade connectors (**Figure 26.1**).
6. Double check that the igniter wires are clear of any movement, i.e. ash drawer, firepot cleaning rod, etc.
7. Re-install the ash drawer and side panel and re-connect the power.

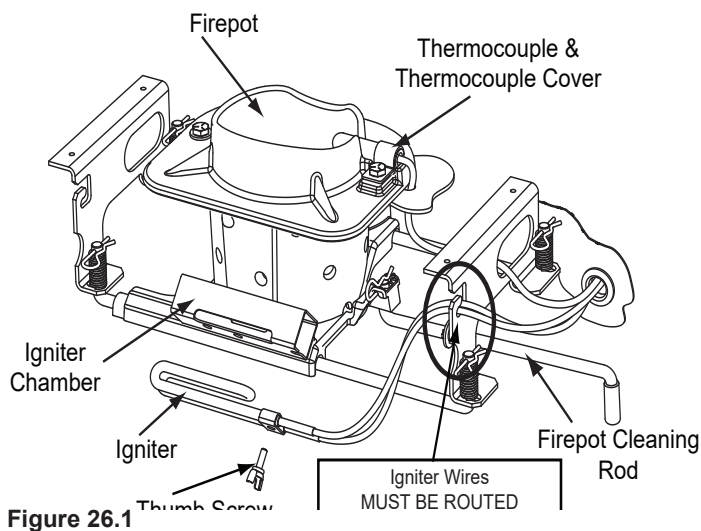

Figure 26.1

### E. Baffle Removal & Replace

1. Shut down the appliance by turning down the thermostat and let the appliance completely cool down.
2. Remove the center baffle first by using the handle at the top of the baffle and pull up and then towards you. The hooks on the baffle will slide out of the slots in the bracket (**Figure 26.2**).
3. Remove the left baffle and then the right baffle by pulling up and then towards you. The left and right baffles have similar hooks and slots (**Figures 26.3 and 26.4**).
4. Re-install the baffles in reverse order. Be careful to insert the hooks in their respective slots. Be sure the baffles are completely secure/seated (close, if not touching, the firebox floor).

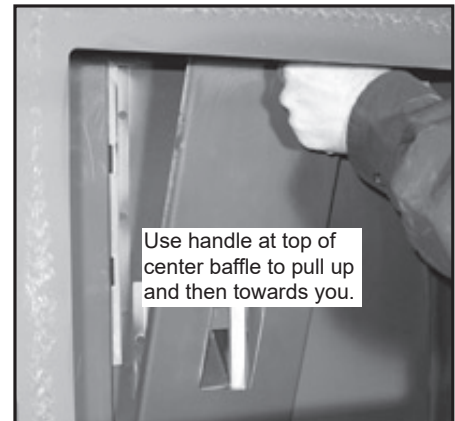

Figure 26.2

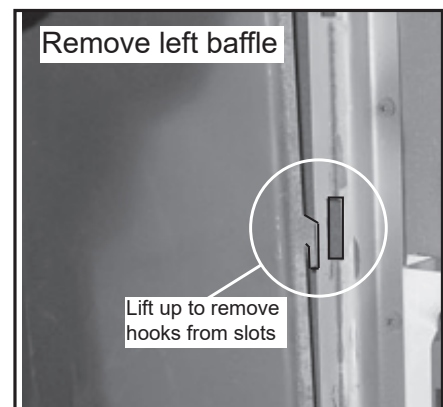

Figure 26.3



Figure 26.4

## F. Glass Replacement

1. Open the door from the appliance by lifting door off of hinge pins and lay on a flat surface face down.
2. Using a Phillips Head screw driver, remove the 4 brackets and set aside (**Figure 27.1**).
3. Remove old glass and replace with the new glass.
4. Re-install the brackets using the same screws.

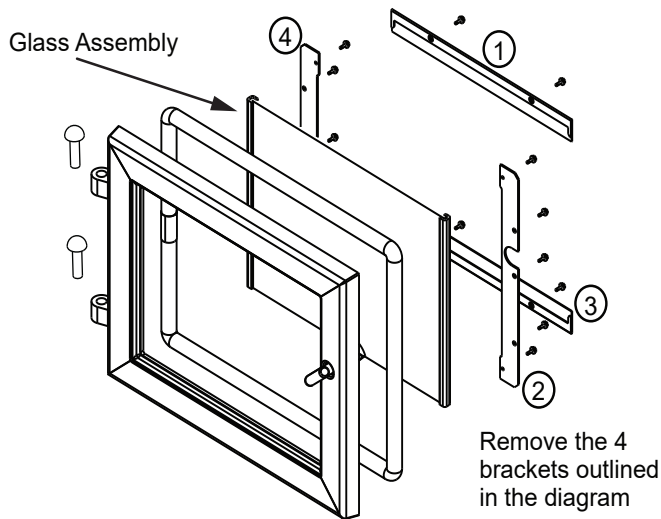

Figure 27.1



### WARNING



- Glass is 5mm thick high temperature heat-resistant ceramic glass.
- DO NOT REPLACE with any other material.
- Alternate material may shatter and cause injury.

# 6 Reference Materials

## A. Component Functions

### 1. Control Box

- The control box is located on the lower left side of the appliance, behind the lower left side panel and above the junction box.
- There is a light located inside of the control box. The internal light will turn green when the appliance has reached a temperature of 200°F (93°C) in the fire pot. and will turn red when it reaches 600°F (315°C).
- There is also an internal blue light located in the control box. When you plug in the appliance the blue light will automatically start blinking. For model PS35 the blue light should flash 7 times every 10 seconds for the first 60 seconds after power up. For models PS50 and CAB50 it should blink 2 times.

To set your control board on the correct number:

- Unplug the appliance.
- Using #2 Phillips screw driver, 3/8" wrench, or 3/8" socket loosen the three screws that hold the right upper and lower side panels in place. You do not need to remove the screws. Remove side panels by lifting up and out.
- Use a #2 Phillips screw driver to remove the control box retainer bracket and lift control box out of the junction box.
- Using a 1/4 inch flat head screw driver turn the rotary switch until the desired number is showing on the dial.
- Re install control box and plug in appliance.
- To confirm your selection is correct count the number of times the blue light flashes.

**Example:** If you are on setting 2 the control box will flash 2 times every 10 seconds for 1 minute.

See chart below for correct control box setting for your model (**Figure 28.1**).

Model	Factory Control Board Setting
PS 35	#7 (7 Flashes)
PS50 / CAB50	#2 (2 Flashes)

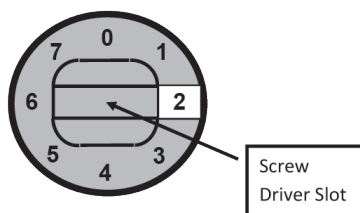

**Figure 28.1 - Rotary Switch**

**NOTE:** Do NOT open the control box. This will void the warranty. If you need to plug in or remove the control box you must first unplug the appliance.

**When describing the location of a component, it is always AS YOU FACE THE FRONT OF THE APPLIANCE.**

### 2. Convection Blower

The convection blower is mounted at the bottom rear of the appliance. There are 2 impellers, one on each side of the motor. The convection blower pushes heated air through the heat exchange system into the room.

### 3. Exhaust Blower

The exhaust blower is mounted on the right side of the appliance. The exhaust blower is designed to pull the exhaust from the appliance and push it out through the venting system.

### 4. Feed System

The feed system is located on the right side of the appliance and can be removed as an entire assembly. The assembly includes the feed motor, mounting bracket, bearing and feed spring (auger). The hollow feed spring (auger) pulls pellets up the feed tube from the hopper area and drops them down the feed chute into the fire pot.

### 5. Fire pot

The fire pot is made of high quality ductile iron and has a cleaning pull-out rod. The floor of the fire pot opens for cleaning when you pull out the rod. Be sure that the floor returns to a completely closed position or your appliance will not operate properly.

### 6. Fuse

The fuse is located on the side of the junction box above to the red call light. The fuse will blow should a short occur and shut off power to the appliance.

### 7. Heat Output Switch

The heat output switch is located on the upper right back panel. The function of the heat output switch is to regulate the burn rates; low, medium and high settings.

### 8. Hopper Switch

The hopper switch is located in the upper right hand corner of the hopper. This switch is designed to shut down the feed motor whenever the hopper lid is opened.

### 9. Igniter

The igniter is mounted on the base of the fire pot. Combustion air travels over the red hot igniter creating super heated air that ignites the pellets.

### 10. Junction Box And Wiring Harness

The junction box is located on the lower left side of the appliance, behind the left side panel. The junction box and wiring harness are replaced as one component.

**11. Power Supply**

The power outlet is located behind the control box on the back of the appliance, lower left corner. Check the wall receptacle for 120 volt, 60 Hz (standard current). Make sure the outlet is grounded and has the correct polarity. A good surge protector is recommended.

**12. Red Call Light**

The red call light is on the side of the junction box, below the fuse. The function of the red call light is to indicate that the thermostat is calling for heat.

**13. Reset Button**

The reset button is located on the back of the appliance in the upper right corner below the heat output control switch. The function of the button is to momentarily open the thermostat circuit, which restarts the system.

**14. Thermocouple**

The thermocouple is located on top of the firepot inside the thermocouple cover (ceramic protection tube). The thermocouple sends a millivolt signal to the control box indicating the preset temperatures of the green and red lights have been obtained.

**15. Thermostat**

The appliance is designed to run on a 12 volt AC thermostat. The heat anticipator should be set on the lowest setting available.

**16. Snap Disc #1 (Convection Blower) 110°F**

Snap disc #1 is located on the right side of the appliance behind the right side panel. There are 2 purple wires connected to it. This snap disc turns the convection blower on and off as needed. Power is always present at snap disc #1.

**17. Snap Disc #2 (Fuel Delivery Interrupt) 175°F**

Snap disc #2 is located on the center of the convection plenum above the convection blower. There is an orange and a black wire connected to it. This snap disc will turn off the feed system which will turn off the appliance if an over fire condition should occur or if the convection blower should fail to operate. If this occurs you will have to manually reset the snap disc.

**18. Snap Disc #3 (Back Burn Protector) 250°F**

Snap disc #3 is mounted on the back of the auger tube in the center of the appliance and has a reset button. There are two gray wires connected to it. To access it remove the right side panel. If the fire tries to burn back into the feed system or push exhaust up the feed tube, this snap disc will shut the entire system off. This disc must be manually reset.

**19. Vacuum Switch**

The vacuum switch is located on the lower right side of the appliance behind right side panel. There are two red wires attached to it. This switch turns the feed system on when vacuum is present in the firebox. The vacuum switch is a safety device to shut off the feed motor if the exhaust or the heat exchanger system is dirty or plugged or if the firebox door is open.

**20. Wiring Harness**

See Figure 29.1 below.

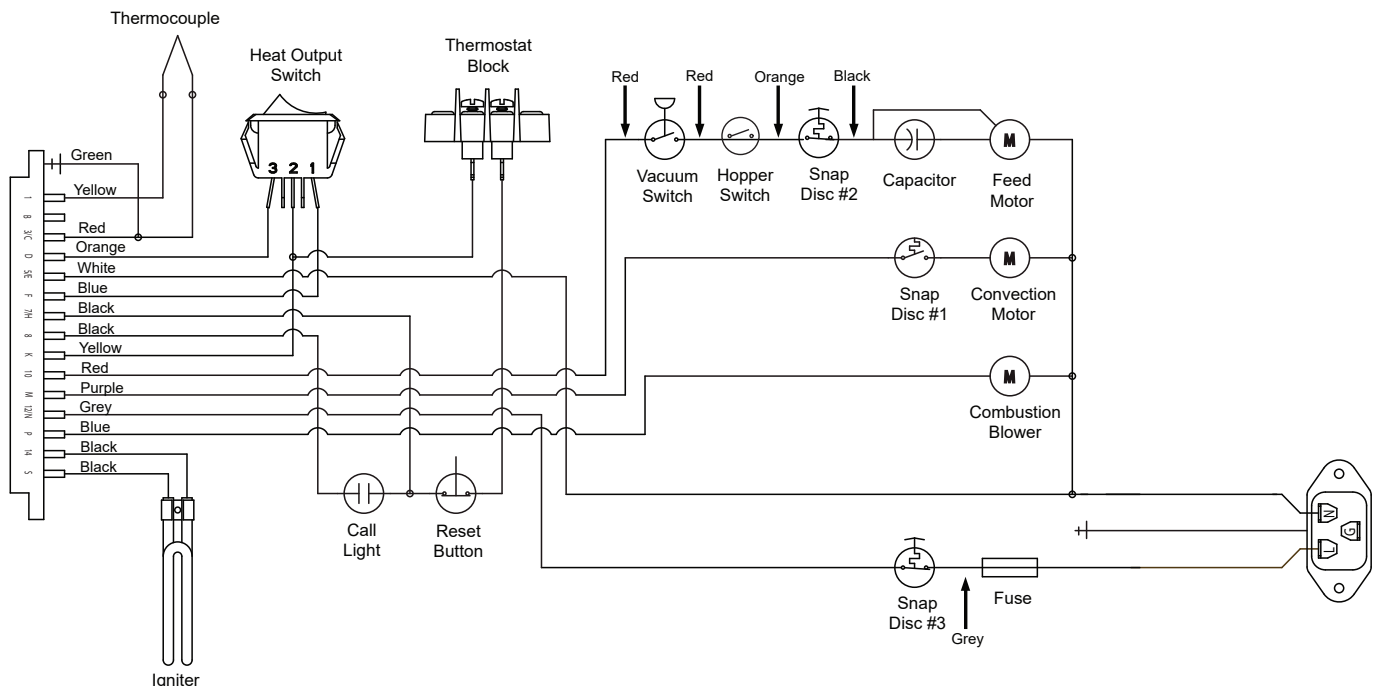

Figure 29.1

**B. Component Locations**

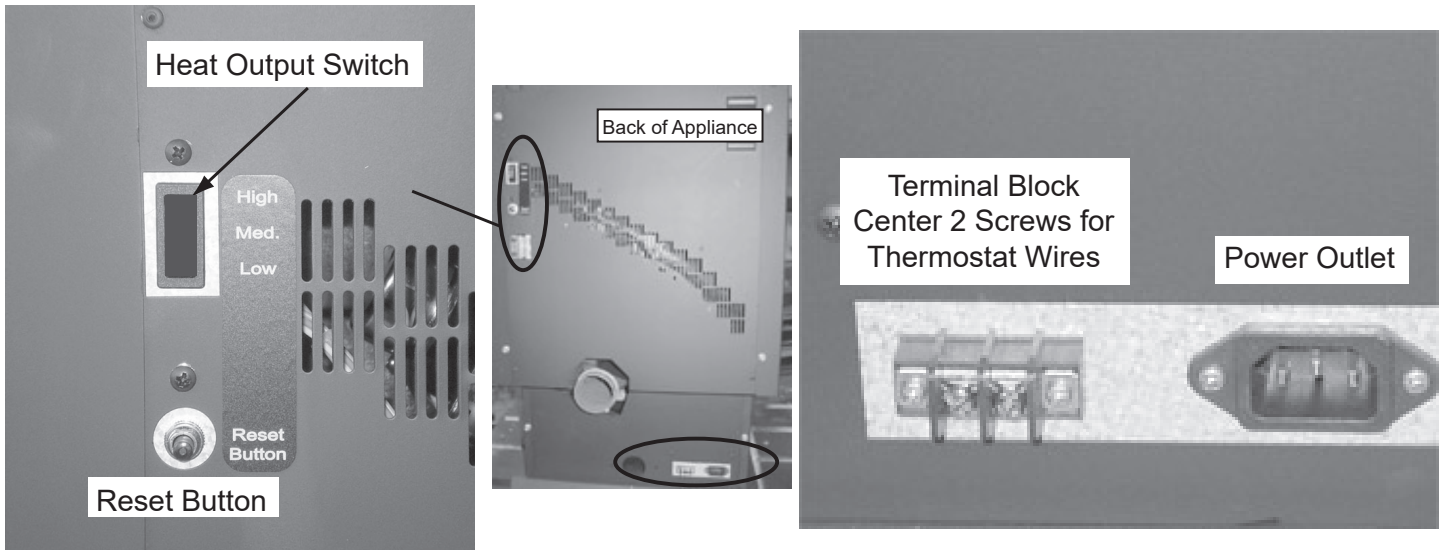

Figure 30.1

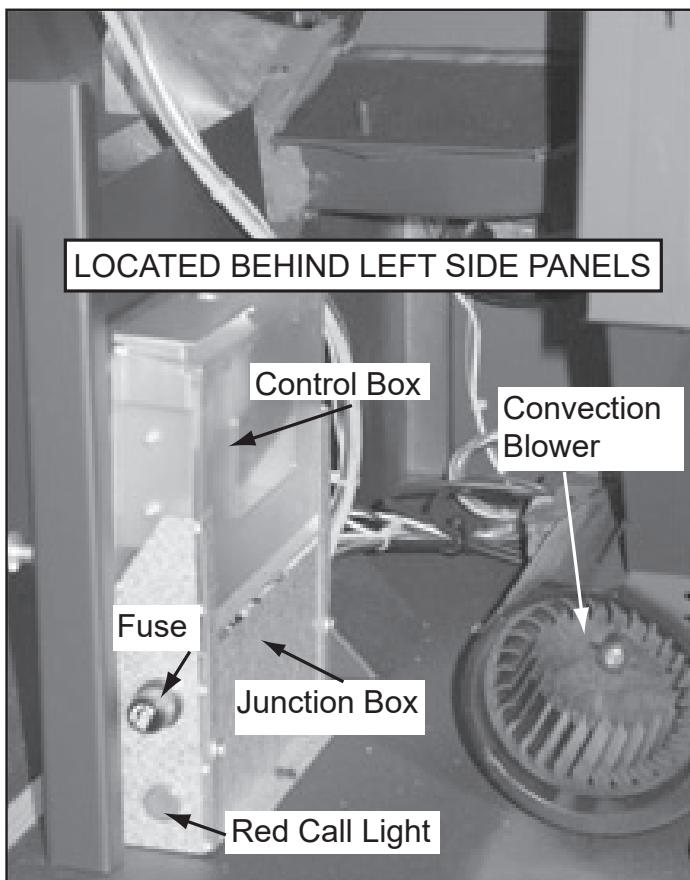

Figure 30.2

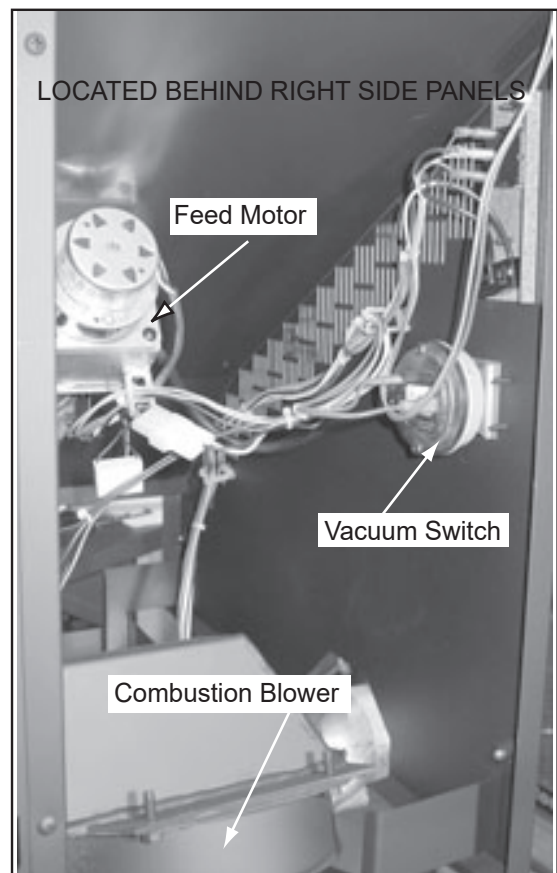

Figure 30.3



**D. Exploded Drawings & Service Parts - PS35**









**E. Exploded Drawings & Service Parts - PS50**







**F. Exploded Drawings & Service Parts - CAB50**











**CONTACT INFORMATION**

Hearth & Home Technologies  
352 Mountain House Road  
Halifax, PA 17032  
Division of HNI INDUSTRIES

**Please contact your Heatilator dealer with any questions or concerns.  
For the number of your nearest Heatilator dealer  
log onto [www.heatilatorecochoice.com](http://www.heatilatorecochoice.com)**

**CAUTION**



**DO NOT DISCARD THIS MANUAL**

Important operating and maintenance instructions included.

• Read, understand and follow these instructions for safe installation and operation.

• Leave this manual with party responsible for use and operation.



**We recommend that you record the following pertinent information for your heating appliance.**

Date purchased/installed: \_\_\_\_\_

Serial Number: \_\_\_\_\_ Location on appliance: \_\_\_\_\_

Dealership purchased from: \_\_\_\_\_ Dealer phone: 1(\_\_\_\_) \_\_\_\_ - \_\_\_\_\_

Notes: \_\_\_\_\_

\_\_\_\_\_

\_\_\_\_\_

This product may be covered by one or more of the following patents: (United States) 5341794, 5263471, 6688302, 7216645, 7047962 or other U.S. and foreign patents pending.

