

## MI-ALK-AU

Models: I30X-N-AU, I30X-P-AU, I35X-N-AU  
*Installation Instructions*

### LIGHTS NOT RECOMMENDED WITH MAGIC GLASS



Leave this instruction with party responsible for use and operation.



**HOT GLASS WILL CAUSE BURNS.**

**DO NOT TOUCH GLASS UNTIL COOLED.**

**NEVER ALLOW CHILDREN TO TOUCH GLASS.**

A barrier designed to reduce the risk of burns from the hot viewing glass is provided with this appliance and shall be installed for the protection of children and other at-risk individuals.

**CAUTION! Risk of Burns!** The fireplace should be turned off and cooled before servicing.

**CAUTION! Risk of Cuts or Abrasions.** Wear protective gloves and safety glasses during installation. Sheet metal edges are sharp.

**CAUTION! Do not install damaged components.** If you received components that are damaged, contact your dealer for assistance.

#### Tools and Supplies Needed:

- Screw Gun
- 1/4 in. (6 mm) Hex Driver Bit
- 3/8 in. (10 mm) Wrench
- Multi-purpose tool (appliance manual bag)
- Gloves

#### KIT CONTENTS:

- Light Assembly
- 50 Watt Ember Bulb (2)
- Accent Glass (2)
- Light Glass Hold Down (2)
- Valve Tub Gasket
- Light Glass Gasket (4)
- 10-32 Nut (8)
- Ember Rocks

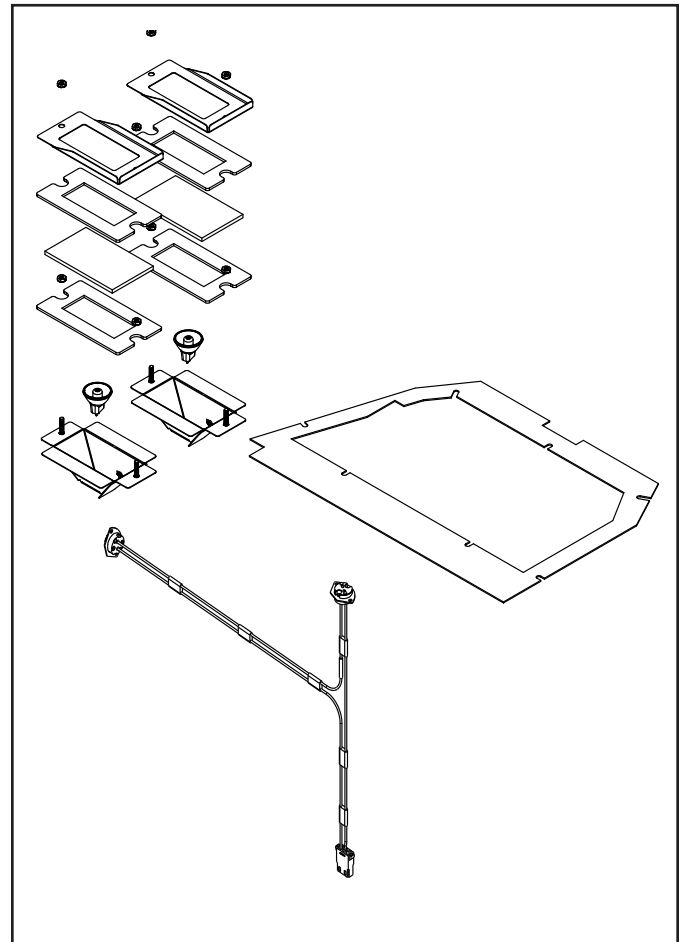

Figure 1. Kit Contents

## PREPARATION

1. Shut off gas supply and disconnect electrical power.
2. Remove decorative front, glass assembly, glass seal plate, mystic embers, embers and logs if previously installed.
3. Remove the screws that attach the base pan to the burner and lift the base pan out of the appliance.
4. Remove the burner bracket screw. Slide burner to the left and lift out of the appliance. Be careful not to damage the pilot sense rod.
5. Remove the screws from the valve tub. The pilot wires, pilot gas tube, and flex orifice line will still be attached to the valve tub. Set the valve tub to the side in order to allow access to the underside of the firebox. See Figure 2 and 3. Remove and discard old valve tub gasket.

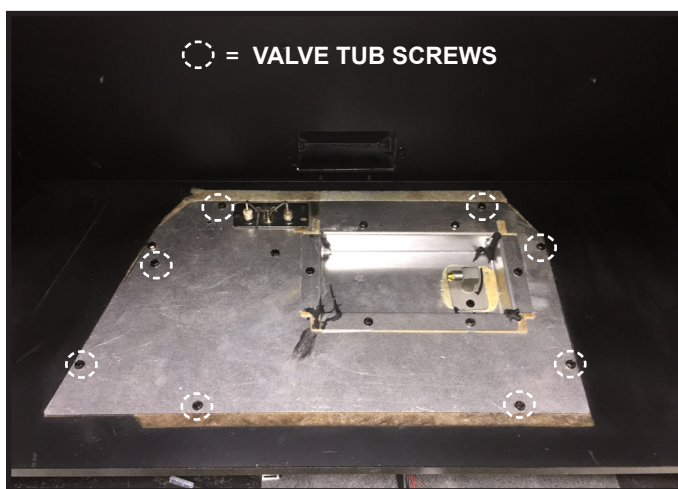

Figure 2.

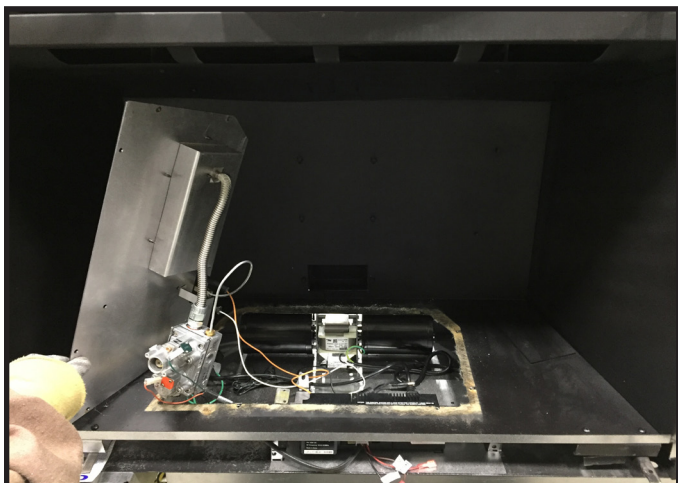

Figure 3.

6. Remove the 6-pin wire harness and the regulator wire harness from the wire hold down tabs on the component tray. Slide the locking tab over and slide the component tray forward for easier access. See Figure 4.



Figure 4.

7. Using a 3/8 in. (10 mm) wrench, loosen and remove the nuts attaching the cover plates, four (4) total. Remove cover plates and old gaskets.

## INSTALLATION

1. Layout MI-ALK-AU parts so they are readily accessible. The wire harness is not symmetrical; thus, there is a left and right light tub. See Figure 5.

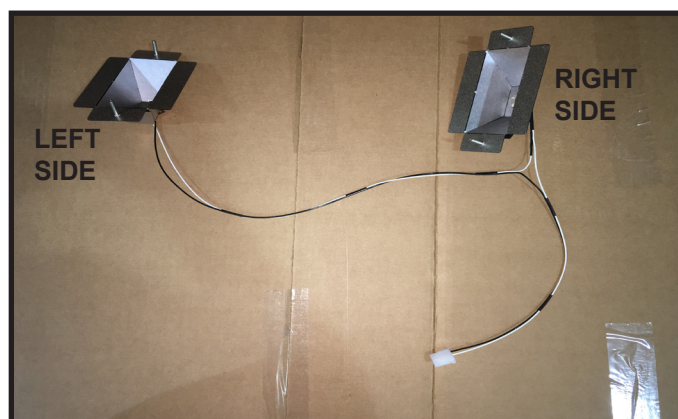

Figure 5.

- Remove pilot wires from post. See Figure 6. Route left light tub under the pilot wires, reinstall pilot wires into post. See Figure 7.

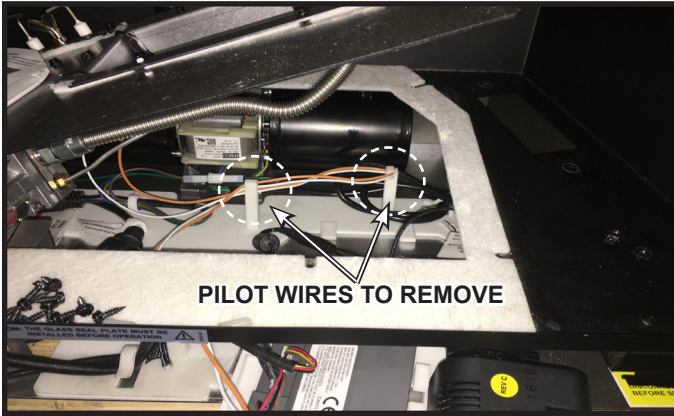

Figure 6.

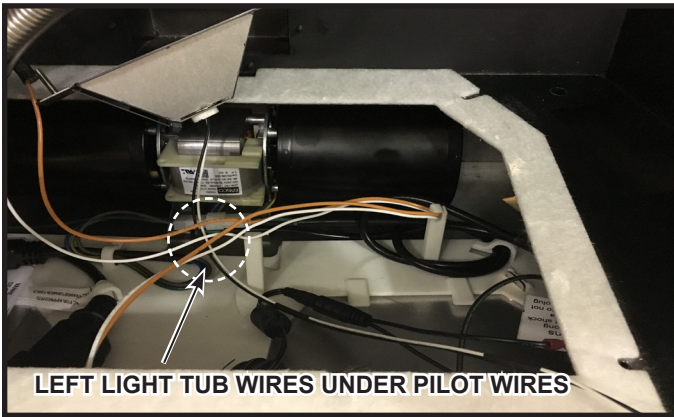

Figure 7.

- Place a gasket over each light tub and then install them from under side of the firebox bottom. See Figure 8.  
**Note:** Install light tub so light deflector plate is toward the front of the appliance. Failure to do this will result in excess light seen underneath the appliance. See Figure 9.



Figure 8.

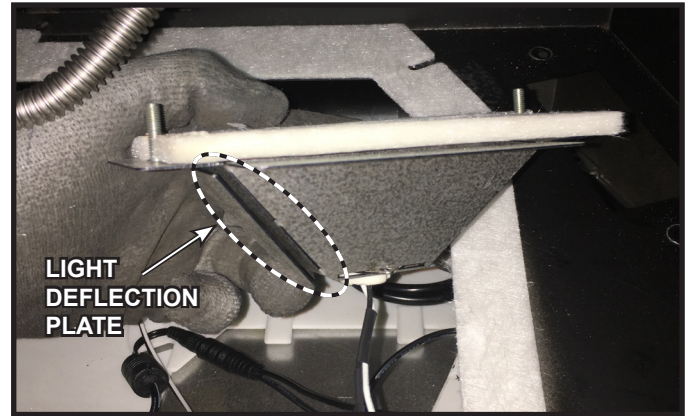

Figure 9.

- Once threaded studs are inserted through the firebox bottom, use one 10-32 nut on each threaded stud to hold the light tubs in place. Place one light gasket over each light tub inside the firebox. See Figure 10.



Figure 10.

- Install 50 watt bulbs into the light sockets. Be sure not to touch the bulb with bare skin. Latex or rubber gloves are recommended.
- Center accent glass on each gasket. See Figure 11.

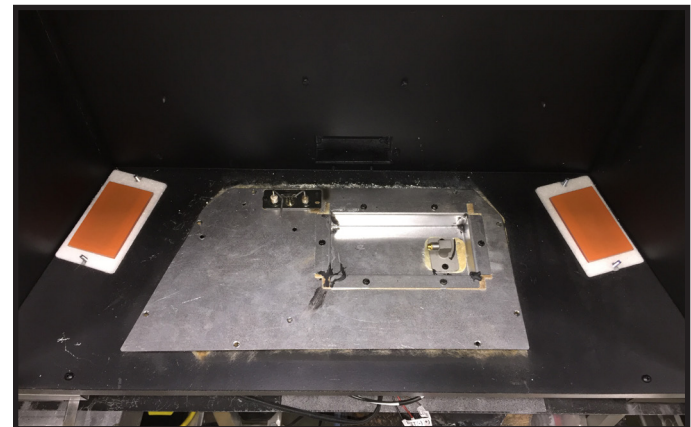

Figure 11.

- Place one light glass hold down over each piece of accent glass. Ensure edge with return bend is towards the front of the firebox. See Figure 12.

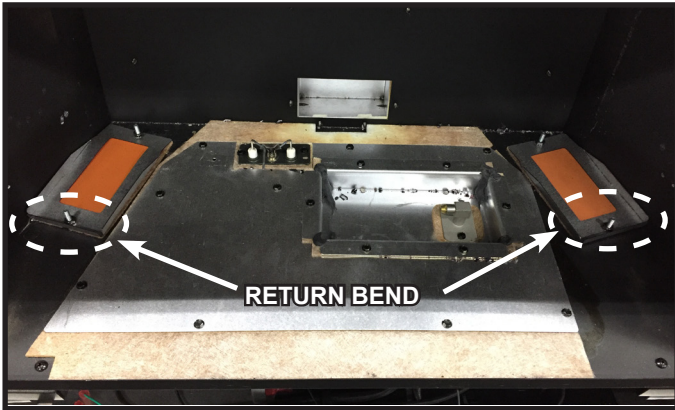

Figure 12.

- Use 10-32 nuts to secure light glass hold down in place.
- Route the light wires as shown in Figure 13 and plug into the AUX port 1 on Auxiliary Control Module. See wiring diagram for reference (Figure 16).

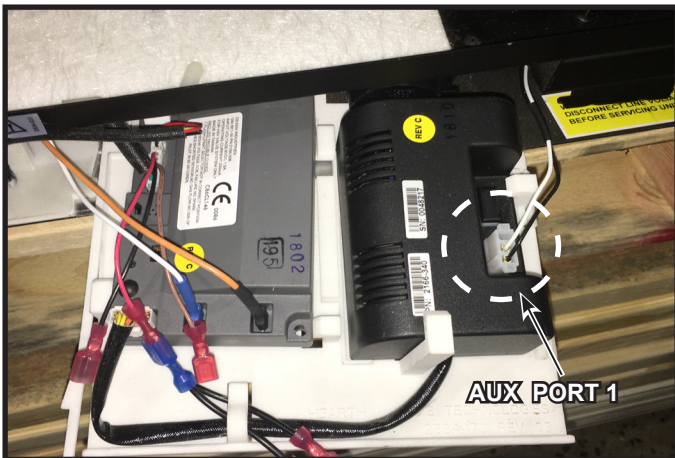

Figure 13.

- Place new valve tub gasket around the valve tub cutout and locate on screw locations.
- Verify the location of the valve tub gasket is correct and re-attach the valve tub.
- Install the burner assembly, one (1) screw.
- Install the base pan assembly, five (5) screws.
- Refer to the RC-300AU remote control instructions to re-program the module and remote for use with lights. This will activate the light controls on the RC-300AU.
- Slide the component tray back into place.

- Install ember rocks by placing directly on the accent glass. Cover until the ember rocks are approximately level with the basepan. Each side will use less than half of the bag of ember rocks. See Figures 14 & 15.

- Re-install glass seal plate, logs, embers, mystic embers, glass assembly and decorative front.



Figure 14.

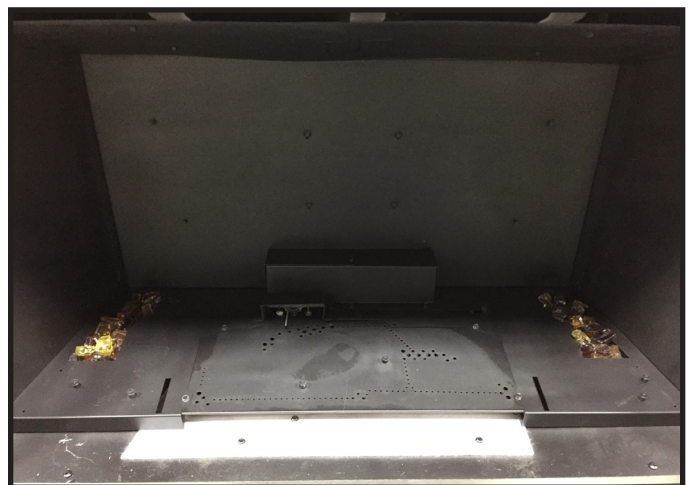

Figure 15.

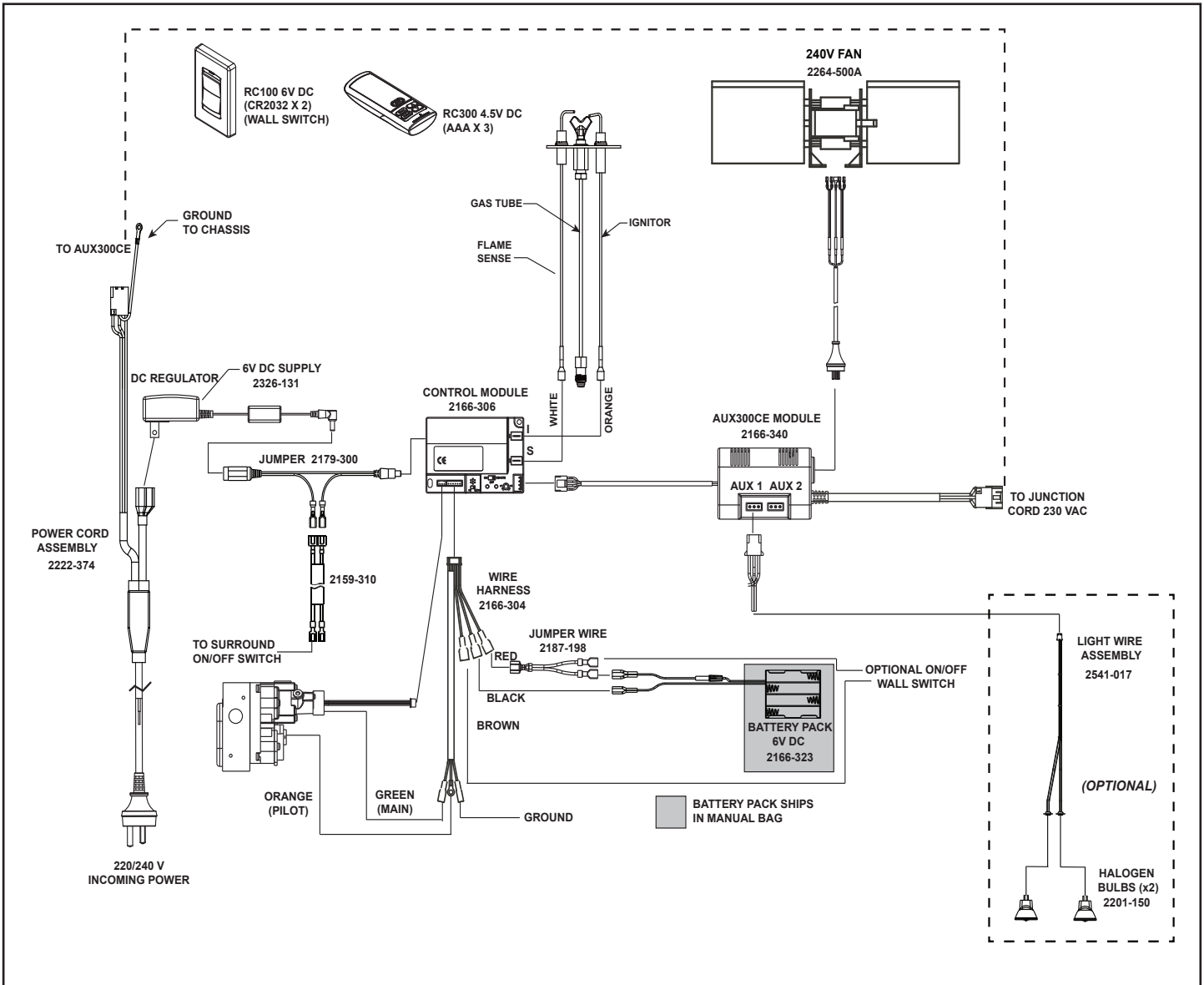

Figure 16. Intellifire™ Plus Wiring Diagram

## Service Parts

PART NUMBER	DESCRIPTION
2201-150	50W Bulb
2541-017	Light Wire Assembly
2532-149	Light Glass Hold Down
2532-150	Light Glass Gasket
2532-151	Accent Glass
2532-131	Valve Tub Gasket
2201-853	Ember Rocks

Please contact your Hearth & Home Technologies dealer with any questions or concerns.  
 For the location of your nearest Hearth & Home Technologies dealer, please visit [www.hearthnhome.com](http://www.hearthnhome.com)

Hearth & Home Technologies  
 7571 215th Street West, Lakeville, MN 55044  
[www.hearthnhome.com](http://www.hearthnhome.com)