

# Owner's Manual

## Operation & Care

**INSTALLER:** Leave this manual with party responsible for use and operation.

**OWNER:** Retain this manual for future reference.

Contact your dealer with questions regarding installation, operation, or service.

**NOTICE: DO NOT DISCARD THIS MANUAL**

# QUADRA-FIRE®

## MT. VERNON PELLET APPLIANCE

### ADVANCED ENERGY (AE)

**Model(s):**

**MTVERNON-AE-CSB      MTVERNON-AE-MBK**  
**MTVERNON-AE-PBK      MTVERNON-AE-PDB**  
**MTVERNON-AE-PFT      MTVERNON-AE-PMH**

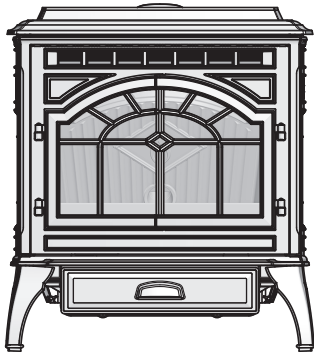

### **WARNING**



**If the information in these instructions is not followed exactly, a fire may result causing property damage, personal injury, or death.**

- Do not store or use gasoline or other flammable vapors and liquids in the vicinity of this or any other appliance.
- Do not over fire - If appliance or chimney connector glows, you are over firing. Over firing will void your warranty.
- Comply with all minimum clearances to combustibles as specified. Failure to comply may cause house fire.

### **WARNING**



**HOT SURFACES!**  
 Glass and other surfaces are hot during operation AND cool down.

**Hot glass will cause burns.**

- Do not touch glass until it is cooled
- NEVER allow children to touch glass
- Keep children away
- CAREFULLY SUPERVISE children in same room as fireplace.
- Alert children and adults to hazards of high temperatures
- **High temperatures may ignite clothing or other flammable materials.**
- Keep clothing, furniture, draperies and other flammable materials away.

### **CAUTION**

Tested and approved for wood pellets, shelled field corn, wheat and black oil sunflower seeds. Burning of any other type of fuel voids your warranty.

### **CAUTION**

- Check building codes prior to installation.
- Installation **MUST** comply with local, regional, state and national codes and regulations.
  - Consult local building, fire officials or authorities having jurisdiction about restrictions, installation inspection, and permits.

Installation and service of this appliance should be performed by qualified personnel. Hearth & Home Technologies recommends HHT Factory Trained or NFI certified professionals.



### **NOTE**

To obtain a French translation of this manual, please contact your dealer or visit [www.quadrafire.com](http://www.quadrafire.com)

Pour obtenir une traduction française de ce manuel, s'il vous plaît contacter votre revendeur ou visitez [www.quadrafire.com](http://www.quadrafire.com)

# Congratulations

and Welcome to the Quadra-Fire Family!

**NOTE: Clearances may only be reduced by means approved by the regulatory authority having jurisdiction**

**A. Sample of Serial Number / Safety Label**  
**LOCATION: Back of Appliance**



**CAUTION:** HOT WHILE IN OPERATION DO NOT TOUCH, KEEP CHILDREN, CLOTHING AND FURNITURE AWAY. CONTACT MAY CAUSE SKIN BURNS. SEE NAMEPLATE AND INSTRUCTIONS. Operate this unit with fuel hopper lid closed. Failure to do so may result in emissions products' combustion from the hopper under certain conditions. Maintain hopper seal in good condition. Do no over fill the hopper.

**ATTENTION:** CHAUD LORS DE L'OPÉRATION. NE PAS TOUCHER. GARDEZ LES ENFANTS ET LES VÊTEMENTS LOIN DE L'ESPACE DÉSIGNÉ DE L'INSTALLATION. LE CONTACT PEUT CAUSER DES BRÛLURES À LA PEAU. VOIR L'ÉTIQUETTE ET LES INSTRUCTIONS. Opérez cet appareil avec le couvercle de la trémie fermé. Le défaut de ne pas suivre les instructions peut résulter sous certaines conditions, en une combustion des émissions des produits venant de la trémie. Ne pas remplir la trémie trop pleine.

Serial No. →

Model Name →

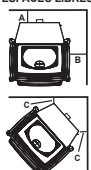

U.S. ENVIRONMENTAL PROTECTION AGENCY  
 Certified to comply with 2015 particulate emission standards at 1.7 g/hr EPA Method 28 and 50. Not approved for sale after May 15, 2020.

ESPACE LIBRE MINIMUM DES MATÉRIEL COMBUSTIBLES:

A 2 in (51mm)	E 6 in (152mm)
B 6 in (152mm)	F 8 in (203mm)
C 2 in (51mm)	G 3 in (76mm)
D 3 in (76mm)	

INSTALLATION DE L'ALCÔVE

Une hauteur minimum de l'alcôve: 43 in (1092mm)

Une hauteur minimum mur de côté de l'alcôve: 6 in (152mm)

Une épaisseur minimum mur de côté de l'alcôve: 40 in (1016mm)

La profondeur maximum de l'alcôve: 36 in (914mm)

Note 1: Dans les installations résidentielles, lorsque les pièces TPVNT-MV, (dessus de l'adaptateur de ventilation 3 in. - 3 in.) et 812-3570 (le dessus de l'adaptateur 3 in. - 6 in.), un tuyau connecteur de 6 in. pour mur simple de calibre 24 peut être utilisé.

Note 2: Pour l'installation dans les maisons préfabriquées, lorsque les pièces TPVNT-MV, (dessus de l'adaptateur de ventilation 3 in. - 3 in.) et 812-3570 (le dessus de l'adaptateur 3 in. - 6 in.), utilisez un tuyau connecteur encastré pour mur double. Un assemblage d'air extérieur (pièce 811-0872), doit être utilisé pour l'installation dans les maisons préfabriquées.

PROTECTION DU SOL

I* = 2 in. (51mm)
J = 2 in. (51mm)
K = 6 in. (152mm)

Installez et le poêle doit être placé sur une assise non combustible s'étendant tout autour de lui, comme les schémas l'indiquent. Mesurez la distance du devant (K) de la surface de la porte vitrée.

\*Un protecteur incombustible de plancher doit s'étendre sous le conduit de cheminée po à une installation de ventilation horizontale ou sous un adaptateur de ventilation de dessus pour une installation verticale. CANADA - REQUIRANT.

Appareil de chauffage inséré de combustible solide/de type de bouillettes. Accepté dans l'installation dans les maisons mobiles. Cet appareil a été testé et enregistré pour l'usage dans les Maisons Mobiles en accord avec OAR 814-23-9000 jusqu'à 814-23-509.

Testé à ASTM E1509-04, ULC S627-00, ULCORD-C1482-M1990 Room Heating Pellet Burning Type, (UM) 84-HUD POUR USAGE AVEC LES BOULETTES DE BOIS. VOIR LE MANUEL DU PROPRIÉTAIRE POUR D'AUTRES OPTIONS DE CARBURANT.

OMNI-Test Laboratories, Inc. a déterminé que cet appareil se conforme avec la norme de l'Association Canadienne de normalisation (CSA) B415.1 ainsi que le Titre 40 du Code Fédéral de Régulations des États-Unis, partie 60, sous-partie AAA. Accréditations OMNI-Test Laboratories: Le Conseil Canadien des Normes (CONSC), l'Institut des Standards Nationaux Américain (ANSI) et l'Agence de Protection Environnemental (EPA).

Puissance de Rendement: 53,300 Btu/hrs

Puissance Electrique: 115 VAC, 60 Hz, Débit 5 Amps, Courir 1.25 AMPs

Éloignez le fil électrique de l'appareil. Ne pas faire passer le fil électrique au dessus ou en dessous de l'appareil.

**DANGER:** Il y a risque de décharge électrique. Déconnectez le électrique de la prise de contact avant le service.

Remplacez la vitre seulement avec une vitre céramique.

AVIS - Pour Les Maisons Mobiles: Ne pas installer dans une chambre à coucher. Un tuyau extérieur de combustion d'air doit être installé et ne doit pas être obstrué lorsque l'appareil est en usage. La structure intégrale du plancher, du plafond et des murs de la maison mobile doit être maintenue intacte.

Référez vous aux instructions du fabricant et des codes locaux pour les précautions requises pour passer une cheminée à travers un mur ou un plafond combustible, et les compensations maximums. Inspectez et nettoyez la cheminée fréquemment.

Ne pas connecter cet appareil à une cheminée servant un autre appareil.

Utilisez un système de ventilation "L" ou "P" diamètre 70mm ou 102mm.

**MINIMUM CLEARANCES TO COMBUSTIBLE MATERIALS**

Listed Solid Fuel Room Heater/Pellet Type Stove. Also suitable for Mobile Home Installation. This appliance has been tested and listed for use in Manufactured Homes in accordance with OAR 814-23-9000 through 814-23-9002.

Tested to ASTM E1509-04, ULC S627-00, ULCORD-C1482-M1990 Room Heating Pellet Burning Type, (UM) 84-HUD FOR USE ONLY WITH PELLETIZED WOOD. See Owner's Manual for other fuel options.

OMNI-Test Laboratories, Inc. has determined that this appliance complies with the Standards Association (CSA) B415.1 and Title 40 of the U.S. Code of Federal Regulations, Part 60 of Part AAA. OMNI-Test Laboratories Accredited: The Standards Council of Canada, American National Standards Institute, and the U.S. Environmental Protection Agency.

Input Rating: 53,300 Btu/s/hr  
 Electrical Rating: 115 VAC, 60 Hz, Start 5 Amps, Run 1.25 AMPs.

Route power cord away from unit. Do not route cord under or in front of appliance. Do not obstruct the space beneath the heater.

**DANGER:** Risk of electrical shock. Disconnect power supply before servicing. Replace glass only with 5mm ceramic available from your dealer. To start, set thermostat above room temperature, the stove will light automatically. To shutdown, set thermostat to below room temperature. For further instruction refer to owner's manual. Keep viewing and ash removal doors tightly closed during operation.

**ALCOVE INSTALLATION:**

Min. Alcove Height: 43 in. (1092mm)

Min. Alcove Side Wall: 6 in. (152mm)

Min. Alcove Width: 40 in. (1016mm)

Max. Alcove Depth: 36 in. (914mm)

A 2 in (51mm)  
 B 6 in (152mm)  
 C 2 in (51mm)  
 D 3 in (76mm)  
 E 6 in (152mm)  
 F 8 in (203mm)  
 G 3 in (76mm)

Note 1: In residential installations, when using Parts TPVNT-MV, (3 in. - 3 in. Top Vent Adapter) and 812-3570 (3 in. - 6 in. Offset Adapter), 2 1/2 in. - 6 in. Offset Adapter, 3 in. - 6 in. Offset Adapter) use listed double wall fuel connector. A 6 in. single wall fuel connector may be used.

Note 2: In manufactured home installation, when using Part TPVNT-MV, (3 in. - 3 in. Top Vent Adapter) and 812-3570 (3 in. - 6 in. Offset Adapter), use listed double wall fuel connector. An Outside Air Kit (Part 811-0872), must be used with manufactured home installation.

**FLOOR PROTECTION**

I\* = 2 in. (51mm)  
 J = 2 in. (51mm)  
 K = 6 in. (152mm)

Use a non-combustible floor protector, extending beneath heater and to the front/sides/rear as indicated. Measure front distance (K) from the surface of the glass door.

\*Non-combustible floor protection must extend beneath the flue pipe when installed with horizontal venting or under Top Vent Adapter with vertical installation. R.C.C.OMNITEST, U.S.A.

DO NOT REMOVE THIS LABEL  
 NE PAS ENLEVER L'ÉTIQUETTE

**QUADRA-FIRE**

MT. Vernon Pellet Stove AE

SERIAL NO. / NUMÉRO DU

007001

JAN FEB MAR APR MAY JUN  
 JULY AUG SEPT OCT NOV DEC  
 2015 2016 2017

Report / Rapport  
 061-S-68-6

This wood heater needs periodic inspection and repair for proper operation. Consult the owner's manual for further information. It is against federal regulations to operate this wood heater in a manner inconsistent with the operating instructions in the owner's manual.

7034-107G

Mfg. Date →

Test Lab & Report No. →

2

7034-276H

May 12, 2017

**⚠ Safety Alert Key:**

- **DANGER!** Indicates a hazardous situation which, if not avoided will result in death or serious injury.
- **WARNING!** Indicates a hazardous situation which, if not avoided may result in death or serious injury.
- **CAUTION!** Indicates a hazardous situation which, if not avoided, may result in minor or moderate injury.
- **NOTICE:** Indicates practices which may cause damage to the appliance or to property.

**TABLE OF CONTENTS**

A. Sample of Serial Number / Safety Label.....	2	<b>4 Maintenance and Service.....</b>	<b>22</b>
B. Warranty Policy.....	4	A. Proper Shutdown Procedure .....	22
<b>1 Listing and Code Approvals.....</b>	<b>7</b>	B. Quick Reference Maintenance Chart.....	22
A. Appliance Certification .....	7	C. General Maintenance and Cleaning .....	23
B. BTU & Efficiency Specifications.....	7	D. Soot or Creosote Fire .....	27
C. Glass Specifications .....	7	E. High Ash Fuel Content Maintenance .....	27
D. Electrical Rating.....	7	<b>5 Troubleshooting Guide .....</b>	<b>28</b>
E. Mobile Home Approved .....	7	<b>6 Service Parts Replacement .....</b>	<b>29</b>
<b>2 Operating Instructions .....</b>	<b>8</b>	A. Glass Replacement - Door Assembly .....	29
A. Fire Safety .....	8	B. Baffle Removal .....	29
B. Non-Combustible Materials .....	8	C. Convection Blower Replacement .....	30
C. Combustible Materials .....	8	D. Combustion (Exhaust) Blower Replacement.....	30
D. Fuel Material and Fuel Storage .....	8	<b>7 Reference Materials.....</b>	<b>31</b>
E. General Operating Information .....	9	A. Component Functions .....	31
F. Before Your First Fire .....	10	B. Component Locations.....	33
G. Filling the Hopper with Fuel.....	10	C. Exploded Drawings.....	34
H. Starting Your First Fire .....	10	D. Service Parts List.....	35
I. Fire Characteristics & Flame Height Adjustment .....	10		
J. Clear Space.....	11		
K. Ignition Cycles .....	11		
L. Frequently Asked Questions .....	13		
<b>3 Wall Control Operating Instructions</b>	<b>14</b>		
A. Introduction.....	14		
B. Language Selection .....	14		
C. The Main Screen .....	14		
D. General Information About Using the Wall Control.....	15		
E. The Main Menu.....	15		
F. Quick Start Guide .....	19		
G. Service Information .....	21		
H. Error Codes .....	21		
I. Battery Back-up System (Optional).....	21		

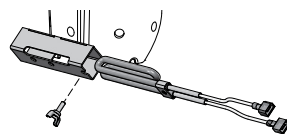

A 300 Watt Igniter comes installed in a brand new Mt. Vernon AE and are for use with pellet fuel only. The 380 Watt Igniter is required for burning multi-grain fuels and is included in the component pack. Multi-fuels include, corn, sunflower seeds, and wheat.

C. Warranty Policy

**Hearth & Home Technologies  
LIMITED LIFETIME WARRANTY**

Hearth & Home Technologies, on behalf of its hearth brands (“HHT”), extends the following warranty for HHT gas, wood, pellet and electric hearth appliances that are purchased from an HHT authorized dealer.

**WARRANTY COVERAGE:**

HHT warrants to the original owner of the HHT appliance at the site of installation, and to any transferee taking ownership of the appliance at the site of installation within two years following the date of original purchase, that the HHT appliance will be free from defects in materials and workmanship at the time of manufacture. After installation, if covered components manufactured by HHT are found to be defective in materials or workmanship during the applicable warranty period, HHT will, at its option, repair or replace the covered components. HHT, at its own discretion, may fully discharge all of its obligations under such warranties by replacing the product itself or refunding the verified purchase price of the product itself. The maximum amount recoverable under this warranty is limited to the purchase price of the product. This warranty is subject to conditions, exclusions and limitations as described below.

**WARRANTY PERIOD:**

Warranty coverage for consumers begins at the date of installation. In the case of new home construction, warranty coverage begins on the date of first occupancy of the dwelling or six months after the sale of the product by an independent, authorized HHT dealer/distributor, whichever occurs earlier. However, the warranty shall commence no later than 24 months following the date of product shipment from HHT, regardless of the installation or occupancy date. The warranty period for parts and labor for covered components is produced in the following table.

The term “Limited Lifetime” in the table below is defined as: 20 years from the beginning date of warranty coverage for gas appliances, and 10 years from the beginning date of warranty coverage for wood and pellet appliances. These time periods reflect the minimum expected useful lives of the designated components under normal operating conditions.

Warranty Period		HHT Manufactured Appliances and Venting							Components Covered
Parts	Labor	Gas (Indoor)	Gas/Wood (Outdoor Protected) *	Pellet	Wood	Electric	Venting		
1 Year		X	X	X	X	X	X	All parts and material except as covered by Conditions, Exclusions, and Limitations listed	
2 Years				X	X			Igniters, auger motors, electronic components, and glass	
		X		X	X			Factory-installed blowers	
		X			X			Molded refractory panels Ignition Modules	
3 Years				X				Firepots, burn pots, mechanical feeders/auger assemblies	
5 Years	1 Year	X			X	X		Vent Free burners, Vent Free ceramic fiber logs, Aluminized Burners	
								Castings and Baffles	
6 Years	3 Years				X			Catalyst - limitations listed	
7 Years	3 Years			X	X			Manifold tubes, HHT chimney and termination	
10 Years	1 Year	X						Burners, logs and refractory	
Limited Lifetime	3 Years	X		X	X			Firebox and heat exchanger, Grate and Stainless Steel Burners, FlexBurn® System (engine, inner cover, access cover, and fire back)	
90 Days		X	X	X	X	X	X	All replacement parts beyond warranty period	

\* Not designed for direct outdoor environment, see HHT Outdoor products. When installed outdoors, installation must strictly follow HHT Outdoor Protected Outdoor Applications Guidelines available from HHT Authorized Dealers.

**WARRANTY CONDITIONS:**

- This warranty only covers HHT appliances that are purchased through an HHT authorized dealer or distributor. A list of HHT authorized dealers is available on the HHT branded websites.
- This warranty is only valid while the HHT appliance remains at the site of original installation.
- This warranty is only valid in the country in which the HHT authorized dealer or distributor that sold the appliance resides.
- Contact your installing dealer for warranty service. If the installing dealer or distributor is unable to provide necessary parts, contact the nearest HHT authorized dealer or supplier. Additional service fees may apply if you are seeking warranty service from a dealer other than the dealer from whom you originally purchased the product.
- Check with your dealer in advance for any costs to you when arranging a warranty call. Travel and shipping charges for parts are not covered by this warranty.
- Limited Catalyst Warranty
  - For wood burning products containing a catalyst, the catalyst will be warranted for a six-year period as follows: if the original catalyst or a replacement catalyst proves defective or ceases to maintain 70% of its particulate emission reduction activity (as measured by an approved testing procedure) within 36 months from the purchase date, the catalyst will be replaced for free.
  - From 37 to 72 months a pro-rated credit will be allowed against a replacement catalyst and labor credit necessary to install the replacement catalyst. The proration rate is as follows:

Amount of Time Since Purchase	Credit Towards Replacement Cost
0 – 36 Months	100%
37 – 48 Months	30%
49 – 60 Months	20%
61 – 72 Months	10%

- Any replacement catalyst will be warranted under the terms of the catalyst warranty for the remaining term of the original warranty. The purchaser must provide the name, address, and telephone number of the location where the product is installed, proof of original purchase date, date of failure, and any relevant information regarding the failure of the catalyst.

**WARRANTY EXCLUSIONS:**

This warranty does not cover the following:

- Changes in surface finishes as a result of normal use. As a heating appliance, some changes in color of interior and exterior surface finishes may occur. This is not a flaw and is not covered under warranty.
  - Damage to printed, plated, or enameled surfaces caused by fingerprints, accidents, misuse, scratches, melted items, or other external sources and residues left on the plated surfaces from the use of abrasive cleaners or polishes.
  - Repair or replacement of parts that are subject to normal wear and tear during the warranty period are not covered. These parts include: paint, wood and pellet gaskets, firebricks, grates, flame guides, batteries and the discoloration of glass.
  - Minor expansion, contraction, or movement of certain parts causing noise. These conditions are normal and complaints related to this noise are not covered by this warranty.
- Damages resulting from: (1) failure to install, operate, or maintain the appliance in accordance with the installation instructions, operating instructions, and listing agent identification label furnished with the appliance; (2) failure to install the appliance in accordance with local building codes; (3) shipping or improper handling; (4) improper operation, abuse, misuse, continued operation with damaged, corroded or failed components, accident, or improperly/incorrectly performed repairs (5) environmental conditions, inadequate ventilation, negative pressure, or drafting caused by tightly sealed constructions, insufficient make-up air supply, or handling devices such as exhaust fans or forced air furnaces or other such causes; (6) use of fuels other than those specified in the operation instructions; (7) installation or use of components not supplied with the appliance or any other components not expressly authorized and approved by HHT; (8) modification of the appliance not expressly authorized and approved by HHT in writing; and/or (9) interruptions or fluctuations of electrical power supply to the appliance.
- Non-HHT venting components, hearth connections or other accessories used in conjunction with the appliance. Any part of a pre-existing fireplace system in which an insert or a decorative gas appliance is installed.
  - HHT's obligation under this warranty does not extend to the appliance's capability to heat the desired space. Information is provided to assist the consumer and the dealer in selecting the proper appliance for the application. Consideration must be given to the appliance location and configuration, environmental conditions, insulation and air tightness of the structure.

**This warranty is void if:**

- The appliance has been over-fired, operated in atmospheres contaminated by chlorine, fluorine, or other damaging chemicals. Over-firing can be identified by, but not limited to, warped plates or tubes, deformation/warping of interior cast iron structure or components, rust colored cast iron, bubbling, cracking and discoloration of steel or enamel finishes.
- The appliance is subjected to prolonged periods of dampness or condensation.
- There is any damage to the appliance or other components due to water or weather damage which is the result of, but not limited to, improper chimney or venting installation.

**LIMITATIONS OF LIABILITY:**

- The owner's exclusive remedy and HHT's sole obligation under this warranty, under any other warranty, express or implied, or in contract, tort or otherwise, shall be limited to replacement, repair, or refund, as specified above. In no event will HHT be liable for any incidental or consequential damages caused by defects in the appliance. Some states do not allow exclusions or limitation of incidental or consequential damages, so these limitations may not apply to you. This warranty gives you specific rights; you may also have other rights, which vary from state to state.

EXCEPT TO THE EXTENT PROVIDED BY LAW, HHT MAKES NO EXPRESS WARRANTIES OTHER THAN THE WARRANTY SPECIFIED HEREIN. THE DURATION OF ANY IMPLIED WARRANTY IS LIMITED TO DURATION OF THE EXPRESSED WARRANTY SPECIFIED ABOVE.

# 1 Listing and Code Approvals

## A. Appliance Certification

<b>Model</b>	Mt. Vernon Pellet Appliance
<b>Laboratory</b>	OMNI Test Laboratories, Inc.
<b>Report No.</b>	061-S-68-6
<b>Type</b>	Solid Fuel Room Appliance/Pellet Fuel Burning Type
<b>Standard</b>	ASTM E1509-04, ULC S627-00 and ULC/ORD-C1482-M1990 Room Appliance Pellet Fuel Burning type and (UM) 84-HUD, Mobile Home Approved.
<b>FCC</b>	Complies with Part 15 of FCC Rules. Operation is subject to the following two conditions: (1) this device may not cause harmful interference, and (2) this device must accept any interference received, including interference that may cause undesired operation.

**NOTICE:** This installation must conform with local codes. In the absence of local codes you must comply with the **ASTM E1509-04, ULC S627-00, (UM) 84-HUD and ULC/ORD-C-1482.**

The Quadra-Fire Mt. Vernon AE Pellet Appliance meets the U.S. Environmental Protection Agency's emission limits for pellet inserts sold after May 15, 2015.

This pellet appliance needs periodic inspection and repair for proper operation. It is against federal regulations to operate this pellet appliance in a manner inconsistent with operating instructions in this manual.

## B. BTU & Efficiency Specifications

EPA Certification #:	970-14
EPA Certified Emissions:	1.7 grams per hour
*LHV Tested Efficiency:	76.9 %
**HHV Tested Efficiency:	71.2 %
***EPA BTU Output:	12,500 to 40,200 / hr.
****BTU Input:	16,800 to 53,300 / hr.
Vent Size:	3 or 4 inches, "L" or "PL"
Hopper Capacity:	75 lbs.
Fuel	Wood Pellets
* Weighted average LHV efficiency using data collected during EPA emissions test.	
**Weighted average HHV efficiency using data collected during EPA emissions test.	
***A range of BTU outputs based on EPA Default Efficiency and the burn rates from the low and high EPA tests.	
****Based on the maximum feed rate per hour multiplied by approximately 8600 BTU's which is the average BTU's from a pound of pellets.	

## C. Glass Specifications

This appliance is equipped with 5mm ceramic glass. Replace glass only with 5mm ceramic glass. Please contact your dealer for replacement glass.

## D. Electrical Rating

115 VAC, 60 Hz, Start 5 Amps, Run 1.25 Amps

## E. Mobile Home Approved

- This appliance is approved for mobile home installations when not installed in a sleeping room and when an outside combustion air inlet is provided.
- The structural integrity of the mobile home floor, ceiling, and walls must be maintained.
- The appliance must be properly grounded to the frame of the mobile home and use only Listed pellet vent Class "L" or "PL" connector pipe.
- Outside Air Kit, part OAK-ACC must be installed in a mobile home installation.



## WARNING



### Fire Risk

Hearth & Home Technologies disclaims any responsibility for, and the warranty will be voided by, the following actions:

- Installation and use of any damaged appliance.
- Modification of the appliance.
- Installation other than as instructed by Hearth & Home Technologies.
- Installation and/or use of any component part not approved by Hearth & Home Technologies.
- Operating appliance without fully assembling all components.
- Operating appliance without legs attached (if supplied with appliance).
- Do NOT Over fire - If appliance or chimney connector glows, you are over firing.

Any such action that may cause a fire hazard.

Improper installation, adjustment, alteration, service or maintenance can cause injury or property damage.

For assistance or additional information, consult a qualified installer, service agency or your dealer.

**NOTE:** Hearth & Home Technologies, manufacturer of this appliance, reserves the right to alter its products, their specifications and/or price without notice.

Quadra-Fire is a registered trademark of Hearth & Home Technologies.

# User Guide

## 2 Operating Instructions

### WARNING



#### Fire Risk

- Do not operate appliance before reading and understanding operating instructions.
- Failure to operate appliance properly may cause a house fire.

### A. Fire Safety

To provide reasonable fire safety, the following should be given serious consideration:

- Install at least one smoke detector and CO monitor on each floor of your home.
- Locate detectors away from the heating appliance and close to the sleeping areas.
- Follow the detector's manufacturer's placement and installation instructions and maintain regularly.
- Conveniently locate a Class A fire extinguisher to contend with small fires.
- In the event of a hopper fire:
  - Evacuate the house immediately.
  - Notify fire department.

### B. Non-Combustible Materials

Material which will not ignite and burn, composed of any combination of the following:

- Steel
- Brick
- Concrete
- Glass
- Plaster
- Iron
- Tile
- Slate

Materials reported as passing **ASTM E 136, Standard Test Method for Behavior of Metals, in a Vertical Tube Furnace of 750° C.**

### C. Combustible Materials

Material made of/or surfaced with any of the following materials:

- Wood
- Plant Fibers
- Plywood/OSB
- Compressed Paper
- Plastic
- Sheet Rock (drywall)

Any material that can ignite and burn: flame proofed or not, plastered or non-plastered.

### D. Fuel Material and Fuel Storage

Pellet fuel quality can greatly fluctuate. This appliance has been designed to burn a wide variety of fuels, giving you the choice to use the fuel that is most economical in your region.

Hearth & Home Technologies strongly recommends only using Pellet Fuel Institute (PFI) certified fuel.

A 300 Watt Igniter comes installed in a brand new Mt. Vernon AE and are for use with pellet fuel only. The 380 Watt Igniter is required for burning multi-grain fuels and is included in the component pack. Multi-fuels include, corn, sunflower seeds, and wheat.

#### Fuel Material

- Made from sawdust or wood by-products
- Shelled field corn & other biomass fuels
- Depending on the source material it may have a high or low ash content.

#### Higher Ash Content Material

- Hardwoods with a high mineral content
- Fuel that contains bark
- Standard grade pellets, high ash pellets, corn and other biomass fuels

#### Lower Ash Content Material

- Softwoods
- Fuels with low mineral content
- Premium grade pellets

#### Shelled Field Corn

- Must be 15% or less moisture content.
- Must be clean and free from debris
- Never burn corn straight from the field
- Stalk parts, excessive fines and cob remnants, etc. will clog the auger mechanism
- Corn with excessive grain dust must be screened by sifting with 3/16 inch (4.7mm) mesh screening

### WARNING

#### Risk of Chemical Poisoning!

Do NOT burn treated seed corn

- Chemical pesticides are harmful or fatal if swallowed
- Burning treated seed corn will void your warranty

### CAUTION!

Do not burn fuel that contains an additive; (such as soybean oil).

- May cause hopper fires
- Damage to product may result

Read the ingredients list on the package. If you are buying corn or wheat the only ingredient that should be listed is corn or wheat.

#### Clinkers

Minerals and other non-combustible materials such as sand will turn into a hard, glass-like substance called a clinker when heated in the fire pot.

Trees from different areas will vary in mineral content. That is why some fuels produce more clinkers than others.



Moisture

Always burn dry fuel. Burning fuel with high moisture content takes heat from the fuel and tends to cool the appliance, robbing heat from your home. Damp pellet fuel can clog the feed system.

Size

- Pellets are either 1/4 inch or 5/16 inch (6-8mm) in diameter
- Length should be no more that 1-1/2 inches (38mm)
- Pellet lengths can vary from lot to lot from the same manufacturer
- Due to length variations, the flame height (feed rate) may need adjusting occasionally. See **page 9** for instructions.

Performance

- Higher ash content requires the ash drawer to be emptied more frequently
- Hardwoods require more air to burn properly
- Set wall control to “Utility Pellet” if the fire pot and ash pan are filling quickly. This will cause the auto-clean system to empty the fire pot more often.
- Premium wood pellets produce the highest heat output.
- Burning pellets longer than 1-1/2 inches (38mm) can cause an inconsistent fuel feed rate and/or missed ignitions.

We recommend that you buy fuel in multi-ton lots whenever possible. However, we do recommend trying various brands before purchasing multi-ton lots to ensure your satisfaction.

Changing to Different Fuel Type

- Empty the hopper of the previous fuel
- Thoroughly vacuum hopper before filling with the new fuel
- Select the appropriate setting on the FUEL SELECTION screen on the thermostat wall control

The burn rate, BTU content and heat output will all vary depending on the fuel selected.

Storage

- Wood pellets should be left in their original sealed bag until using to prevent moisture absorption.
- Shelled corn, wheat or sunflower seeds should be stored in a tight container to prevent it from absorbing moisture from damp or wet floors.
- This will also prevent rodents from becoming a problem.
- Do not store any pellet fuel within the clearance requirements or in an area that would hinder routine cleaning and maintenance.

**CAUTION**

Tested and approved for wood pellets, shelled field corn, wheat and black oil sunflower seeds. Burning of any other type of fuel voids your warranty.

**E. General Operating Information**

Read and understand Section 3: Thermostat Wall Control Operating Instructions for detailed operating instructions. The wall control is an integral part of how to operate this appliance.

**1. Thermostat Wall Control - Automatic Setting**

The appliance is like most modern furnaces; when the thermostat wall control calls for heat, your appliance will automatically light and deliver heat.

When the room is up to temperature and the wall control is satisfied the appliance will shut down.

In the automatic setting the heat output level is controlled by the wall control. Select “Automatic” on the AUTO/MANUAL screen. **Figure 9.1.**

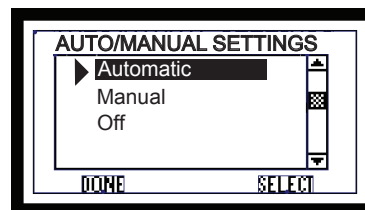
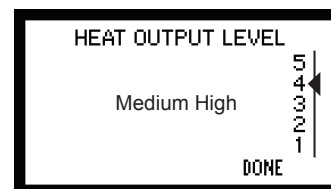

**Figure 9.1**

**2. Thermostat Wall Control - Manual Setting**

When you select “Manual” on the AUTO/MANUAL screen the appliance will still automatically turn on and off according to the temperature setting.

However, you will be able to manually control the heat output levels. Adjust the heat output levels by using the HEAT OUTPUT LEVEL screen. **Figure 8.2.**



**Figure 9.2**

**3. Auto-Clean Fire pot System**

Your appliance is equipped with an automatic fire pot cleaning system that will change the frequency of cleaning based on the fuel being burned.

The auto-clean system will clean itself immediately on initial plug in. If there is a power outage, as soon as power is restored it will recycle and clean itself if there is no fire in the fire pot.

**NOTE:** User is responsible for removing the ash from the ash drawer.

**CAUTION**

Hot while in operation. Keep children, clothing and furniture away. Contact may cause skin burns.

## F. Before Your First Fire

- First, make sure your appliance has been properly installed and that all safety requirements have been met.
- Pay particular attention to the fire protection, venting and thermostat wall control installation instructions.
- Double check that the ash pan, hopper and firebox are empty and then close the firebox door.

**NOTICE:** The tip of thermocouple must be in contact with the inside end of the thermocouple cover or missed ignitions can occur.

## G. Filling the Hopper with Fuel

- Check the hopper and make sure it is empty before filling with fuel.
- Open the cast top hopper lid.
- Do not over fill the hopper. The hopper lid must be completely closed to maintain proper vacuum and for the feed motor to operate. An error ICON will appear on the wall control if the hopper lid is not properly closed.
- Do not leave any part of the fuel bag on the appliance after filling hopper.

## H. Starting Your First Fire

### 1. Fuel Selection

To start your first fire, you must:

- Select the appropriate fuel on the FUEL SELECTION screen on the thermostat wall control to match the fuel you have chosen to burn.
- If the proper fuel is not selected your appliance will not operate properly.
- For example, if you have selected wood pellets and you are burning corn, the appliance may not light, it may go out or overfeed. **Figure 10.1.**

**NOTE:** If you are lighting your appliance for the first time:

- The feed tube will be empty and it can take some time to fill it with fuel before you will see a fire
- Put a handful of fuel in the fire pot (priming) to speed up the process. You can also do this when you have run completely out of fuel.

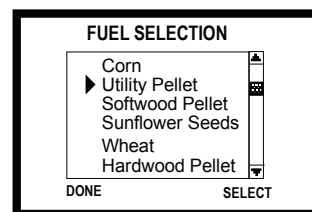
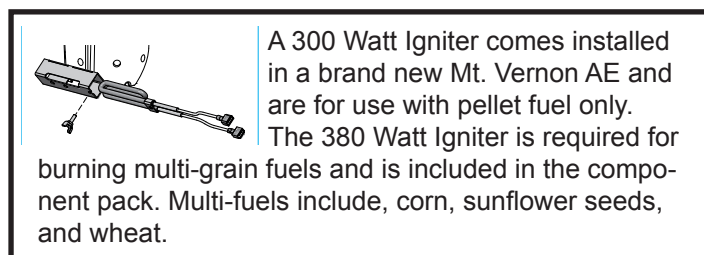

Figure 10.1

### 2. Comfort Level Selection

Once your fuel is selected, select the temperature at the desired setting on the SET COMFORT LEVEL screen. **Figure 10.2.**

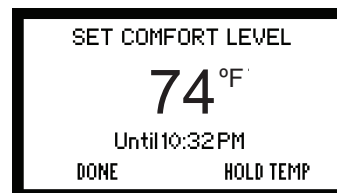

Figure 10.2

### 3. Automatic or Manual Setting

The automatic setting will control the heat output based on the comfort level selection. The manual setting allows you to manually control the heat output settings. **See page 11 Ignition Cycles.**

## I. Fire Characteristics & Flame Height Adjustment

(Feed Rate) A properly adjusted fire will have an active flame pattern and the flame will rise and fall somewhat. This is normal.

- On HIGH setting, the flame will extend approximately 8 inches (203mm) out of the fire pot. If it is not 8 inches (203mm) tall, increase the flame height.
- On MEDIUM or LOW setting the flame will be shorter.
- Reduce the flame height if the fire has tall flames with black tails and seems somewhat lazy. This may also indicate that the fire pot and/or heat exchanger needs to be cleaned. Refer to **Section 4** for Maintenance and Cleaning Instructions.

Adjusting the Flame Height (Feed Rate)

- Set your appliance to “MANUAL” mode on the wall control.
- Set the heat output level to HIGH.
- Adjust the flame height using the “FLAME HEIGHT ADJUST” screen on the wall control. **Figure 9.3.**

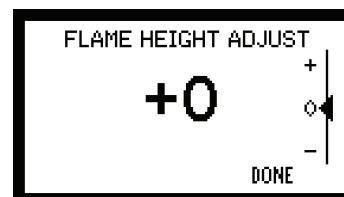

Figure 10.3

**J. Clear Space**

**Mantel:** Avoid placing candles and other heat-sensitive objects on mantel or hearth. Heat may damage these objects.

**NOTICE:** Clearances may only be reduced by means approved by the regulatory authority having jurisdiction.

**⚠ WARNING**

**Fire Risk.**  
Do NOT place combustible objects in front of the appliance. High temperatures may ignite clothing, furniture or draperies. Maintain a minimum clearance of 3 feet (914mm) in front of appliance.

**⚠ WARNING**

**Fire Risk.**  
Keep combustible materials, gasoline and other flammable vapors and liquids clear of appliance.

- Do NOT store flammable materials in the appliance's vicinity.
- **DO NOT USE GASOLINE, LANTERN FUEL, KEROSENE, CHARCOAL LIGHTER FLUID OR SIMILAR LIQUIDS TO START OR "FRESHEN UP" A FIRE IN THIS Appliance.**
- **DO NOT BURN GARBAGE OR FLAMMABLE FLUIDS SUCH AS GASOLINE, NAPHTHA OR ENGINE OIL.**
- **DO NOT USE CHEMICALS OR FLUIDS TO START THE FIRE.**
- Keep all such liquids well away from the appliance while it is in use.
- Combustible materials may ignite.

**K. Ignition Cycles**

The appliance engine is controlled by the digital thermostat wall control. The digital display on the wall control will tell you what your appliance is doing in the upper left corner (System Status). **Figure 11.1.**

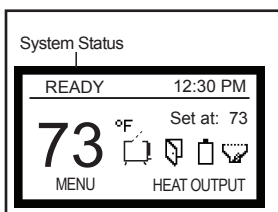

**Figure 11.1**

Every time the thermostat calls for heat, the appliance steps through five cycles:

1	Start-Up Cycle	4	Shutdown Cycle
2	Soft-Start Cycle	5	Auto-Clean Cycle
3	Heating Cycle		

The duration and characteristics of these cycles may be different with each type of fuel selected.

**⚠ WARNING**

**Fire Risk.**  
Do NOT operate appliance:

- With appliance door open
- With fire pot floor open
- With ash pan removed

**1. Start-Up Cycle**

During this cycle:

- Igniter turns on for 90 seconds to heat up the air in the fire pot
- Combustion blower starts
- Vacuum switch comes on
- Feed motor turns on adding fuel to the fire pot and the appliance waits for the fire to start

The duration of start-up depends on the type and quality of fuel used. It is normal to see some smoke during the ignition process as moisture evaporates and the fuel lights. The smoke will stop once the fire starts.

**Note: Appliance may take longer to start up in extreme cold conditions**

**2. Soft Start Cycle (SS-Low / SS-Med)**

Once the fire is lit:

- The appliance moves into the low soft-start cycle as it continues to build the fire
- More fuel will be added
- As the fire builds, the appliance will change to medium soft-start mode
- The heating cycle begins

**3. Heating Cycle ( Auto / Man - L, ML, M, MH, H)**

There are two choices in the Automatic / Manual menu of how your appliance will operate:

**Automatic Mode**

- The wall control will turn the heat output level up or down depending on how far the room temperature is from the desired temperature
- The digital display will read AUTO:M, i.e. automatic-medium level
- As the room temperature approaches the desired temperature, the appliance will turn down to lower settings
- When the home reaches your set temperature, the appliance will go into the shutdown cycle

## Manual Mode

- Set the heat output setting from the main screen
- The right bottom button will read HEAT OUTPUT
- You can operate the appliance from any of the 5 levels
  - On the lowest level (MAN: L) the appliance will stay on longer, burn less fuel per hour, and will take longer to bring the home up to your desired temperature
  - On the highest setting (MAN:H) the appliance will burn more fuel per hour, and bring your home up to temperature more quickly
- In Manual mode the heat output does not change but will stay at the setting you chose until the comfort level is reached (meaning the thermostat has been satisfied). Turn to OFF to stop operation.

## 4. Shutdown Cycle

Once your home has reached your set temperature:

- Appliance will stop feeding fuel and allow fire to diminish
- Convection blower will continue to run until the appliance cools to appropriate temperature
- Appliance will begin the auto-clean cycle

## 5. Auto-Clean Cycle

The fire pot auto-clean system will cycle:

- When the appliance is first plugged in
- When the house reaches temperature and the appliance shuts down
- At prescribed intervals, depending on the type of fuel selected
- When starting up after an electrical interruption

If your appliance is running and the auto-clean cycle is initiated, the appliance will revert to shutdown cycle.

- The floor of the fire pot will open and dump the ash into the ash pan
- It takes approximately 2 minutes to complete the auto-clean cycle
- The floor will then shut, and if the thermostat is still calling for heat, the fire will start again
- During this auto-clean cycle, the convection blower may continue to run. The combustion blower will continue to run.

## Additional Screen Messages:

**READY** It is telling you that the home is up to temperature and doesn't need any heat.

- - - - - The screen will show 5 dashes when the wall control and the control board are NOT communicating with each other. Check that the wiring on the thermostat is properly connected.

**MAINTENANCE BURN** This indicates the appliance is operating on battery backup, prior to the auto-clean. The maintenance burn will keep the system from shutting down as the appliance will not automatically re-light in battery back-up mode.

**OFF** The AUTO/MANUAL SETTING screen has been set to OFF. Set the appliance to OFF when performing periodic maintenance to prevent an unexpected startup.

**BLANK SCREEN** The ON/OFF switch may be in OFF position or make sure electrical power is supplied to the appliance. Turn to ON position.



## WARNING



### Fire Risk

Do NOT operate appliance:

- With appliance door open.
- With fire pot floor open.

Do NOT store fuel:

- Closer than required clearances to combustibles to appliance.
- Within space required for loading or ash removal.

**L. Frequently Asked Questions**

ISSUES	SOLUTIONS
1. Metallic noise	1. Noise is caused by metal expanding and contracting as it heats up and cools down, similar to the sound produced by a furnace or heating duct. This noise does not affect the operation or longevity of your appliance.
2. Ash build-up on glass	2. This is normal. Clean the glass.
3. Glass has turned dirty	3. Excessive build up of ash. The lower burn settings will produce more ash, the higher burn settings produce less. The more it burns on low the more frequent cleaning of the glass is required.
4. Fire has tall flames with black tails and is lazy	4. The flame height adjustment needs to be reduced or the fire pot needs cleaning. Heat exchanger or exhaust blower needs cleaning.
5. Excessive smoky start-up	5. Either the fire pot is dirty or there is too much fuel at start-up and not enough air.
6. Large flame at start-up	6. This is normal. Flame will settle down once the fire is established. Some smoke is normal.
7. Mechanical Noise	7. The floor of the fire pot in the auto-clean system may make some noise as it scrapes the ash into the ash pan.

**Contact your dealer** for additional information regarding operation and troubleshooting.  
 Visit [www.quadrafire.com](http://www.quadrafire.com) to locate a dealer.

<b>CAUTION</b>
<p>Odors and vapors released during initial operation.</p> <ul style="list-style-type: none"> <li>• Curing of high temperature paint.</li> <li>• Open windows for air circulation.</li> </ul> <p>Odors may be irritating to sensitive individuals.</p>

# 3 Wall Control Operating Instructions

## A. Introduction

Welcome to the Quadra-Fire family. This manual will help you understand and operate the wall control attached to your new pellet appliance.

The Quadra-Fire Wall Control is not just a traditional thermostat, but an integral part of the pellet appliance system. While it has many of the features one would expect from an advanced thermostat, including programmable setback capabilities and current temperature display, it also indicates the system's current operating cycle and state. It does this by communicating with the appliance via a wired connection.

Additionally, it allows you to set parameters that will optimize the performance of your pellet appliance system. These parameters are accessed with an easy to navigate menu system.

## B. Language Selection

The language selection function is under the USER SETTINGS found on pages 16. Please refer to that section for complete detailed instructions.

## C. The Main Screen

The key to being comfortable while operating your new wall control is to familiarize yourself with the main screen. The main screen shows, at a glance, the status of the system, the most important settings and the current temperature. Additionally, the main screen indicates with simple icons many user actions required to keep your appliance working as intended. **Figure 14.1.**

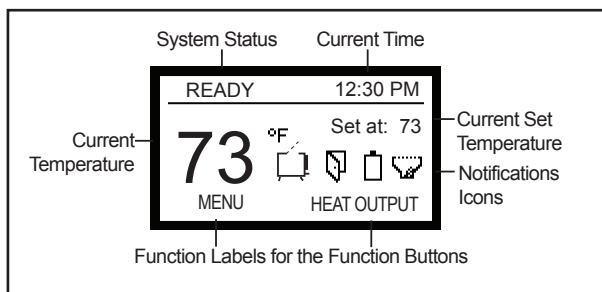

Figure 14.1

### 1. System Status Codes

The status area is used to indicate the current status of the system. It indicates if the system is running in automatic or manual cycle, if it is turned on or off and where it is in the operating sequence.

#### a. START-UP

Indicates that the appliance is in start-up cycle and is in the process of lighting an initial charge of fuel.

#### b. SS-LOW or SS-MED (SS = soft start)

Indicates the soft-start portion of the lighting sequence. In these stages the fire begins to gradually build to operating temperature.

#### c. AUTO: (x) or MAN: (x) (x) = heat output level

Indicates both the operating cycle (automatic or manual) and the current heat output level. The heat output level will be "H" high, "MH" medium high, "M" medium, "ML" medium low and "L" low.

#### d. READY

Indicates that the system is turned on and is functioning normally, but there is no call for heat (the room temperature is not below the set temperature).

#### e. SHUTDOWN

Indicates the system is shutting down, either because it is no longer calling for heat or the maximum burn time has been reached and the system must run an auto-clean cycle.

#### f. AUTO-CLEAN

Indicates the system is running the fire pot auto-clean cycle.

#### g. OFF

Indicates the system has been shut down by the user.

#### h. MAINT BURN (Battery Back-up Only)

The maintenance burn is to keep the system from shutting down when operating on battery backup. The appliance will not automatically re-light in battery back-up mode.

### 2. Current Time

Indicates the current time. The time is used for the programmable setback features of the wall control.

### 3. Set Temperature

Indicates the current set temperature. It will change automatically as the control progresses through the 7 day setback program. If the wall control is in HOLD TEMP cycle the

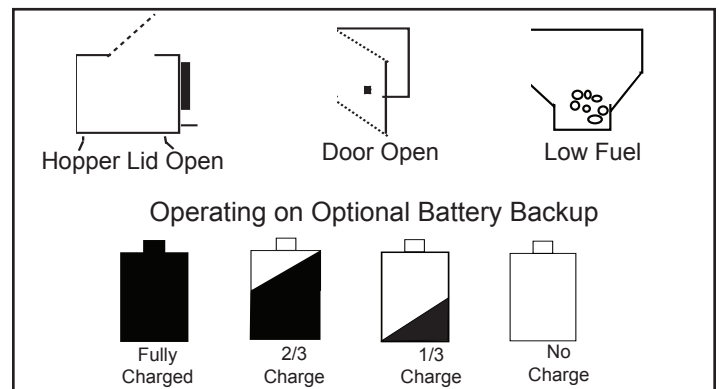

Figure 14.2

“Set at:” indication will change to “Hold at:” and displays the operating temperature setting.

#### 4. Notification Icons

The system notification area uses icons to indicate if an action needs to be taken. In battery mode it indicates the approximate charge level of the battery.

#### 5. Function Buttons

The function buttons have two labels above them in the display area. Their labels can change depending on the menu screen. On the main screen the left button will bring up the system menu and the right button has functionality only in MANUAL cycle. **Figure 15.2.**

#### 6. Current Temperature

The current temperature area indicates the temperature of the room where the wall control is located. The temperature displayed can be in appliances of Fahrenheit or Celsius. The desired appliances can be selected via the system menu. **See Figure 17.11 on page 17.**

### D. General Information About Using the Wall Control

When a button is pressed and the screen changes from the main screen to one of the other screens, the back-light will illuminate the display area. As buttons are pressed, the back-light continues to be illuminated.

Most screens have a DONE button which can be used to return to the previous screen ultimately returning to the main screen.

The wall control will automatically revert back to the starting screen if there is no activity for 15 seconds except for the CONFIRM FUEL CHANGE screen. The main screen will be illuminated for an additional 10 seconds and the back-light will shut off.

If the wall control is subjected to a static shock, the screen may go blank. If this happens, wait 25 seconds and press any button. This will reset the screen restore functionality and turn on the back light. If this does not work, call your dealer.

### E. The Main Menu

The menu is the heart of customizing the operation of the pellet appliance system to your personal liking. The choices on this menu are:

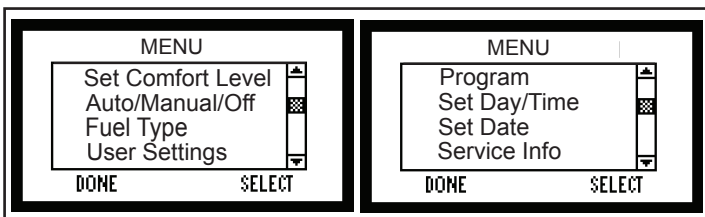

Figure 15.1

### 1. Set Comfort Level (Temperature)

The most basic operation of the wall control is to turn the appliance on or off depending on the requirement for heat. From the main screen, the SET COMFORT LEVEL screen can be activated by pressing the UP or DOWN button on the right side of the display area.

The first time either button is pressed the display changes to the SET COMFORT LEVEL screen and shows the current set temperature. Subsequent presses or holding the UP or DOWN button will change the set temperature. **Figure 15.2.**

You can override the programming either permanently or temporarily. The HOLD TEMP button (lower right) on the SET COMFORT LEVEL screen is used to override preset programming. **Figure 15.3.** By pressing the HOLD TEMP button, the current set temperature will permanently override any programmed temperature in the 7 day setback programming. This is a convenient way of overriding a program when your schedule changes temporarily and you don't want to reprogram the setback functions on the wall control.

To release the permanent override, press the button labeled RESUME when in the HOLD TEMP cycle. Pressing the button again will resume the programming at the next program interval. **Figure 15.4.**

To temporarily override the programming, use the UP and DOWN buttons only and do not press the HOLD TEMP button. The display will show how long the new temperature will hold before it returns to the next scheduled programming. **Figure 15.3.**

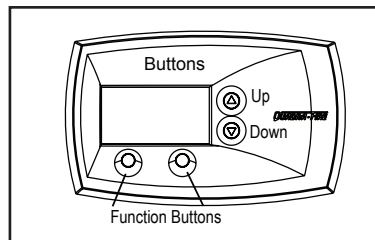

Figure 15.2



Figure 15.3



Figure 15.4

### 2. Auto / Manual / Off Selection

#### a. Automatic

In the AUTOMATIC cycle the wall control will turn the appliance on and off automatically and also turns the heat output level up or down depending on the temperature setting. The further away the room temperature is from the set temperature, the higher the heat output.

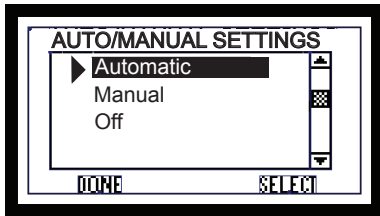

Figure 16.1

**b. Manual**

In MANUAL cycle, the heat output remains the same regardless of the difference between the set and room temperatures. The wall control will function as a simple on/off thermostat. When the system is set to MANUAL the HEAT OUTPUT selection is added in the lower right corner.

Press the button under this selection to access this feature. The HEAT OUTPUT screen is used to set the level of heat produced whenever the wall control calls for heat. **Figure 16.3.** The HEAT OUTPUT screen is not accessible in AUTOMATIC cycle.

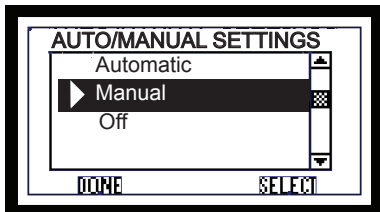

Figure 15.2

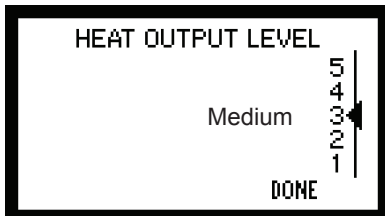

Figure 16.3

**c. OFF**

This selection turns the appliance off. When the appliance is set to OFF, it will not light regardless of room temperature. Use this setting when cleaning and maintaining your appliance.

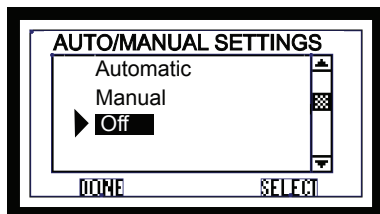

Figure 16.4

**3. Fuel Type**

The FUEL TYPE screen is used to select the fuel that will be used with the pellet system. The list on this screen indicates all fuel choices available to burn in the appliance.

**NOTE:** The list of fuels can be updated by your local dealer as they become available.

To select a fuel type, use the UP/DOWN buttons to scroll to the desired fuel type and then press the button under "Select". The arrow will change to indicate the currently selected fuel.

**NOTE:** If you are burning a high ash fuel set the fuel selection to "Utility Pellets".

When purchasing corn or wheat to burn in your appliance, read the ingredient label very carefully. **Do NOT purchase fuel that contains any additives** such as oils (i.e. soybean oil) and meals as it will result in poor appliance performance. If you are buying corn or wheat the only ingredient that should be listed is corn or wheat.

**4. Program (7 Day Programming)**

The wall control is already programmed at 68°F for all time settings. It will remain there until it is re-programmed.

The wall control can be programmed as a setback thermostat. Each day of the week has four program periods. The wall control menus have some features that make it easy to

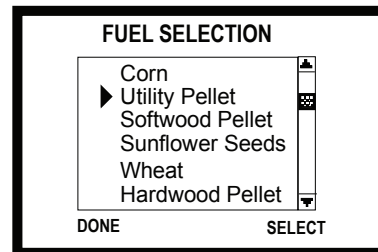

Figure 16.5

program groups of days alike. This minimizes the number of steps required to program the wall control for most applications.

To access the programming screen, select Program from the menu screen and then select the desired programming range from the PROGRAMMING RANGE screen.

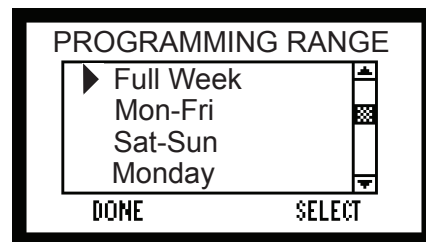

Figure 16.6

**a. Full Week**

**NOTE:** It is important to note that the most recent programming entry will override all previous programming for an individual day or range of days.

The small triangle on the left side indicates the current active programming line. **Figure 15.6.** For each of the four intervals available to program there are three adjustable values: set hour, set minutes and set temperature. You will need to increase or decrease the hour to change from AM to PM.



When the screen is first entered the "Wake Hour" is highlighted. Use the UP/DOWN buttons to adjust the hour to the desired hour and press the button under "Set/Next". The highlight will move to the minutes display. Adjust the minutes and press "Set/Next." The highlight is now on the temperature value. Set the desired temperature for the Wake period and press "Set/Next."

The highlight is now on the hour display for the Day period, and the triangle has moved to the second line. Continue programming each value as desired. (To store the final value be sure to press "Set/Next" to return the highlight to the first value on the screen.)

When you are finished making changes, or if you just entered the programming screen to view the set program, press "Done" or let the display return to the main screen automatically.

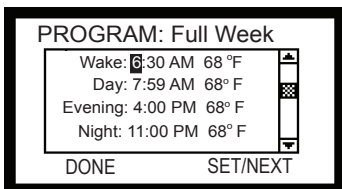

Figure 17.1

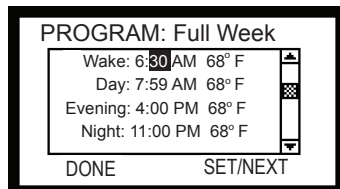

Figure 17.2

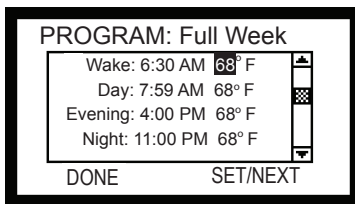

Figure 17.3

## 5. Set Day/time

### a. Set Day/Time

In order for the setback function to work properly the wall control must be aware of the current time. The SET DAY/TIME screen is used to set the system clock. When the screen is entered the day of the week is highlighted.

Use the UP/DOWN buttons to change this to the current day of the week. Press the button under "Set/Next" and the highlight will be moved to the current hour field. Again, use the UP/DOWN buttons to set this to the current hour. Press the "Set/Next" button again and the current minute display is highlighted.

Use the UP/DOWN buttons to adjust to the correct minutes and press "Set/Next" one last time. The highlight will move back to the original day of week display.

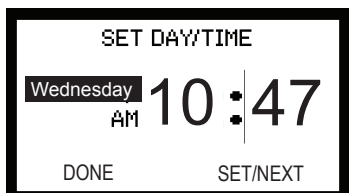

Figure 17.4

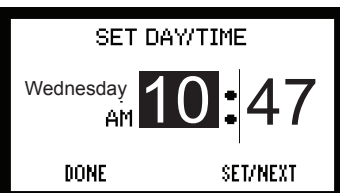

Figure 17.5

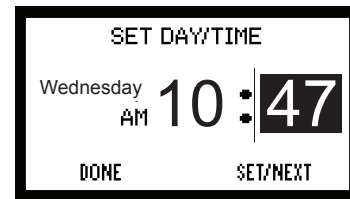

Figure 17.6

### b. Set Date

When the SET DATE screen is entered the month name is highlighted. Use the UP/DOWN buttons to select the proper month then press the button under "Set/Next."

The highlight will move to the day of the month display. Using the UP/DOWN buttons, select the current date then press "Set/Next." The highlight will move to the year display. Select the current year and press "Set/Next" then the highlight will be back on the month name display.

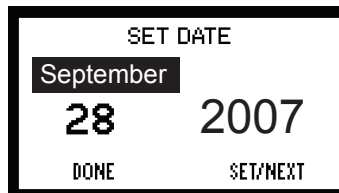

Figure 17.7

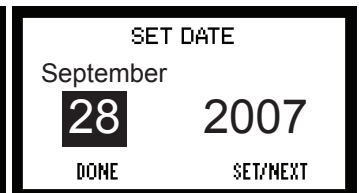

Figure 17.8

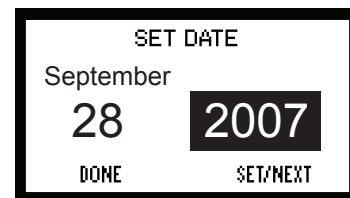

Figure 17.9

## 6. User Settings

Items that are rarely changed are stored under the USER SETTINGS.

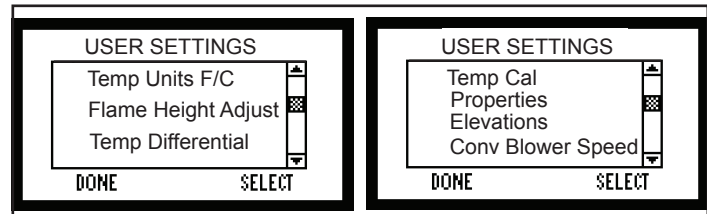

Figure 17.10

### a. Temp Appliances F/C

TEMP Appliances is used to change from Fahrenheit to Celsius and back for the temperatures displayed.

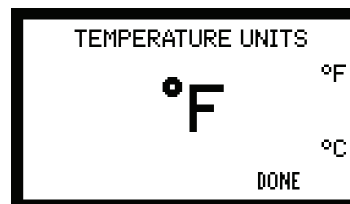

Figure 17.11

**b. Flame Height Adjust**

FLAME HEIGHT ADJUST is used to adjust flame height (fuel feed rate) for specific installation and fuel type. The dealer will usually adjust this if necessary on installation and can advise on specific settings for a particular application.

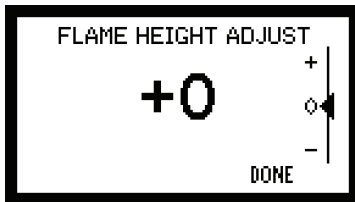

Figure 18.1

**c. Temp Differential**

TEMPERATURE DIFFERENTIAL is used to change the set default temperature differential. This sets how far below the set point the wall control allows the room temperature to fall before the appliance turns back on. It is usually set at time of installation.

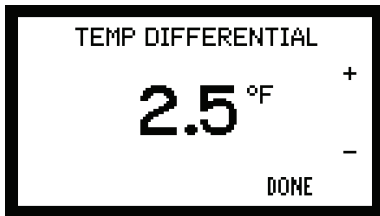

Figure 18.2

**d. Temperature Calibration**

TEMPERATURE CAL is used to calibrate the temperature on the wall control. If for some reason you feel the wall control is not accurately reading the temperature you can calibrate it to a thermostat that you know is accurate. Press the UP/DOWN buttons to desired temperature.

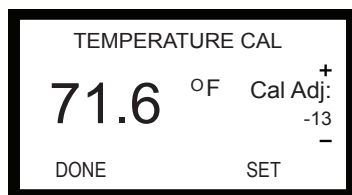

Figure 18.3

**e. Properties**

PROPERTIES shows the version of software for the control board and wall control. If you are placing a service call with your dealer, they may ask you to go to this screen and read them the information under "WC" and "SC".

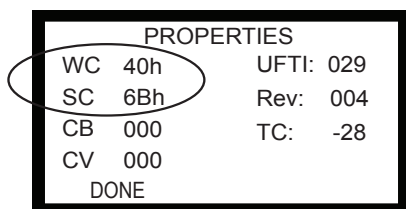

Figure 18.4

**f. Elevation**

ELEVATION allows you to adjust the appliance to your specific elevation. Press the UP/DOWN buttons to select your elevation. The message in the center will change between NORMAL and HIGH. If you select HIGH, it will replace the normal fuel tables with specific high fuel tables. You **MUST** select a fuel type after selecting HIGH.

Please note that changing the elevation will delete any custom or new fuel table loaded into the appliance. You must confirm your choice on the CONFIRM ELEVATION CHANGE screen. This allows you to reverse your decision if necessary. **Figure 18.6**

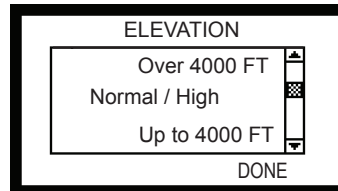

Figure 18.5

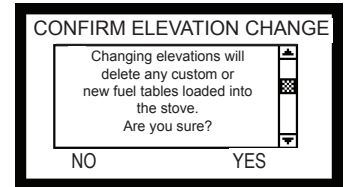

Figure 18.6

**g. Convection Blower Speed**

CONV BLOWER SPEED allows you to adjust the blower speed to your individual preference. Press the UP/DOWN buttons to select your blower speed. The message in the center will change between NORMAL and QUIET.

NORMAL allows the convection blower to reach maximum RPM at 135 degrees and QUIET at 165 degrees.

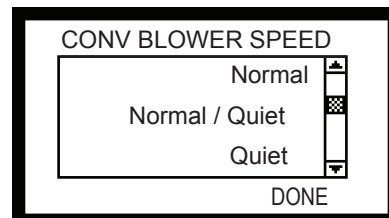

Figure 18.7

**h. Language Selection**

LANGUAGE allows you to select from four different languages. To select a language scroll down to the last item on the USER SETTING screen using the DOWN button. Using the UP/DOWN buttons select the preferred language and then press Select and then press Done.

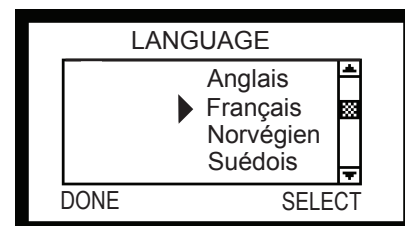
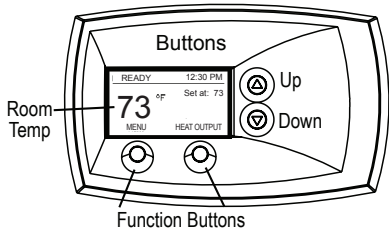

Figure 18.8

F. Quick Start Guide

**NOTICE:** Any button pressed will turn on the backlight. Wall control will automatically revert back to the starting screen if there is no activity for 15 seconds; except for the “CONFIRM FUEL CHANGE” screen.



Wall Control for Reference

**TURNING ON APPLIANCE**



1. At the starting screen, press “MENU”.

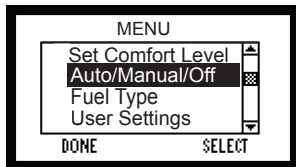

2. Highlight “AUTO/MANUAL/OFF”. Press “SELECT”.

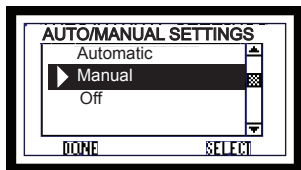

3. Highlight “MANUAL”. Press “SELECT”.
4. Press “DONE” twice or wait 15 seconds for starting screen to re-appear.

**CHOOSING FUEL TYPE**

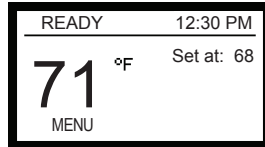

1. At the starting screen, press “MENU” button once or twice until “MENU” screen appears.

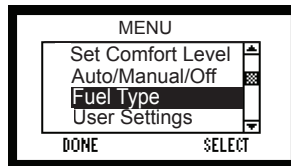

2. Highlight “FUEL TYPE” using the “UP/DOWN” buttons to the right side of the display. Press “SELECT”.

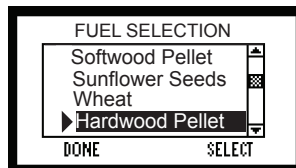

3. Scroll down and highlight “HARDWOOD PELLETT” or your fuel type.
4. Now press “SELECT” to choose new fuel.

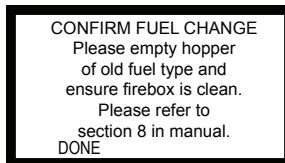

5. Press “DONE” to confirm fuel change.
6. Press “DONE” twice or wait 15 seconds for starting screen to reappear.
7. Fill the hopper with fuel. If the hopper was completely empty or has run out of fuel, put approximately 1/2 cup of pellets into the fire pot for a quick restart.
8. Be sure the hopper lid and glass door are both closed.

**CHOOSING TEMP APPLIANCE: °F or °C**



1. At the starting screen, press “MENU” button once or twice until “MENU” screen appears.

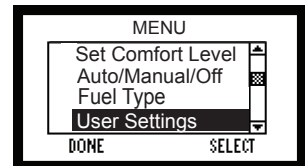

2. Highlight “USER SETTINGS” using the “UP/DOWN” buttons to the right side of the display. Press “SELECT”.

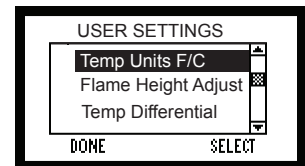

3. Highlight “TEMP ApplianceS F/C” using the “UP/DOWN” buttons to the right side of the display. Press “SELECT”.

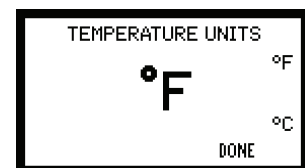

4. Press the “UP” or “DOWN” button to set desired temperature appliance and press “SELECT”..
5. Press “DONE” twice again, or wait 15 seconds for starting screen to re-appear.

**SETTING COMFORT LEVEL**

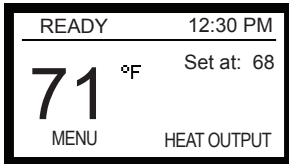

1. Press and hold "UP" or "DOWN" button to set desired temperature.

**NOTE:** Set temperature must be 3 degrees higher than room temperature for appliance to start.



2. Press "HOLD TEMP".



3. Press "DONE".

**SETTING HEAT OUTPUT**

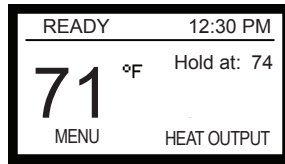

1. At the starting screen, press "HEAT OUTPUT".

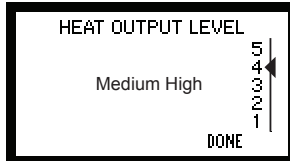

2. Use the "UP" button to change "HEAT OUTPUT LEVEL" to "MEDIUM-HIGH".
3. Press "DONE" twice or wait 15 seconds for starting screen to re-appear.

**HOPPER OUT OF FUEL**

ERROR LIST

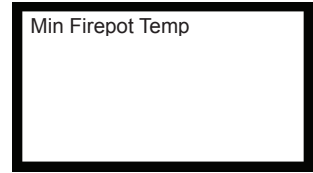

1. If the appliance has stopped operating, check the wall control screen. If it is showing "Min Fire pot Temp" the hopper has run out of fuel.
2. Fill the hopper with fuel and press the "RETRY" button twice. The first time turns on the back light, the second time starts the retry function.

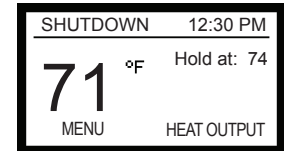

3. If the wall control screen changes to a "SHUTDOWN" screen that means your appliance has not completed the full shutdown cycle. Depending on where it was in the cycle it can take from one to ten minutes to restart.

When the shutdown cycle is complete the wall control screen will display "STARTUP". Continue to Step 4.

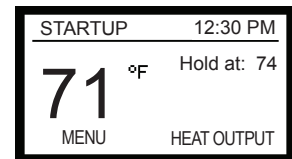

4. If the wall control screen changes to a "STARTUP" screen after pressing "RETRY" that means your appliance has already completed the shutdown cycle. You must wait until the wall control screen displays the startup screen and then put 1/2 cup of pellets in the fire pot for a quick restart.
5. Be sure the hopper lid and glass door are both closed.

### G. Service Information

The SERVICE INFORMATION screen displays contact information for Hearth & Home Technologies Customer Service Line. The local dealer may have changed this upon or before the installation to indicate a dealer hot line.

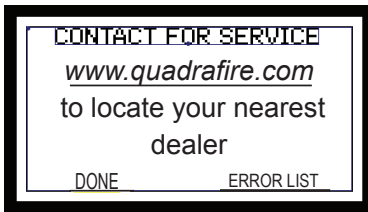

Figure 21.1

### H. Error Codes

If a system error occurs that forces the system to stop operating an error screen appears. Depending upon the error type, up to three retry attempts are allowed after which a service professional is required.

Press the ERROR LIST button to display the latest error. See page 28 for a list of error codes.

### I. Battery Back-up System (Optional)

CAUTION
<ul style="list-style-type: none"> <li>• Hook up to battery terminals BEFORE you plug battery into appliance.</li> <li>• Damage to internal electronic components may occur</li> </ul>

The appliance has been designed to operate on an optional battery back-up system.

If you have frequent power outages in your region, hook the appliance up to a 12 volt battery and it will automatically switch to battery power in the event of a power failure. The 12 volt power cord sold as a separate accessory does not charge the battery.

<p>MANUAL LIGHT PROCEDURE Press "CONTINUE" button to start manual lighting sequence Current Tem: 72° F</p> <p style="text-align: right;">CONTINUE</p>
<p>MANUAL LIGHT PROCEDURE</p> <p>Please wait while feed charge is loading into firepot</p>
<p>MANUAL LIGHT PROCEDURE</p> <p>Open door... Manually light fuel... Close door</p>

Figure 21.2

Refer to owners manual for instructions on how to attach the cable to appliance. The following are screens you will see when using a back-up battery.

#### Operating on Battery Back-Up

- A battery icon appears on your wall control to let you know you are now operating on battery power. **Figure 21.3.**
- Fire must be manually lit as the appliance will no longer automatically light.
- Use only approved fire starting gel to start fire.
- High burn rate is no longer available on battery back-up.
- Each level drops down one level, i.e the high burn becomes medium-high burn and so on.
- If the battery charge falls below 10 volt it can no longer sustain the appliance operation and the appliance will shut down. You must disconnect and reconnect the battery to start it up again.

#### Recommended Battery

- 12 volt deep cycle battery, (i.e., marine or RV type).
- A 12 volt battery cable is available through your local dealer.

<b>WARNING</b>			
<b>Risk of Injury!</b>			
<ul style="list-style-type: none"> <li>• Blowers may continue to run and would be exposed to human contact.</li> </ul>			
 13 Volts	 12 Volts	 11 Volts	 Battery Below 10 Volts

Figure 21.3

#### Wall Control Display

The wall control will display the battery icon when operating in the battery back-up mode. **Figure 21.4.**

"Maint Burn" will display when the thermostat has reached the set room temperature and will run on low until it reaches its auto-clean cycle time.

MAINT BURN	12:30 PM
73 °F	Set at: 73
MENU	HEAT OUTPUT

Battery icon.

Figure 21.4

# 4 Maintenance and Service

When properly maintained, your fireplace will give you many years of trouble-free service. Contact your dealer to answer questions regarding proper operations, trouble-shooting and service for your appliance. Visit [www.quadrafire.com](http://www.quadrafire.com) to locate a dealer. We recommend annual service by a qualified service technician.

## A. Proper Shutdown Procedure

1. Set wall control to OFF on AUTOMATIC / MANUAL SETTING screen. **Figure 22.1.**
2. Wall control screen will scroll through the following messages after setting to OFF.
  - Shutdown
  - Auto-Clean
  - Off
3. Smoke spillage into the room can occur if the appliance is not cool before unplugging.
4. There is a risk of shock if the appliance is not unplugged before servicing the appliance.

After servicing, restart with the AUTO/MANUAL SETTINGS screen. **Figure 22.1.**

## B. Quick Reference Maintenance Chart

Cleaning or Inspection	Frequency		Daily	Weekly	Every 2 Weeks	Monthly	Yearly
Ash Pan - Burning Wood Pellets	Every 5 bags of fuel	OR		X			
Ash Pan - Burning Alternate Fuels	Every 1 bag of fuel	OR	X				
Ash Removal from Firebox	More frequently depending on the fuel type or ash build-up	OR		X			
Auto-Clean Inspection	More frequently depending on the fuel type	OR				X	
Blower, Combustion (Exhaust)	More frequently depending on the fuel type	OR					X
Blower, Convection	More frequently depending on the operating environment	OR					X
Door Latch Inspection	Prior to heating season	OR				X	
Firebox - Prepare for Non-Burn Season	At end of heating season	OR					X
Fire pot - Burning Softwood Pellets	Every 5 bags	OR		X			
Fire pot - Burning Hardwood Pellets	Every 3 bags	OR		X			
Fire pot - Burning Alternate Fuels	Every 1 bag	OR	X				
Glass	When clear view of fire pot becomes obscured	OR		X			
Heat Exchanger & Drop Tube	Every 1 ton of fuel	OR			X		
Hopper	Every 1 ton of fuel or when changing fuel types	OR				X	
Venting System	More frequently depending on the fuel type	OR					X

**NOTICE:** These are recommendations. Clean more frequently if you encounter heavy build-up of ash at the recommended interval or you see soot coming from the vent. Not properly cleaning your appliance on a regular basis will void your warranty.

## Before Servicing Your Appliance

**CAUTION**

**CAUTION! SHOCK AND SMOKE HAZARD!**

- Proper Shutdown Procedure must be followed.
- Smoke spillage into room can occur if appliance is not cool before unplugging appliance.
- Risk of shock if appliance is not turned off before servicing appliance.

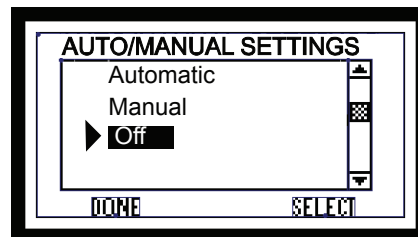

**Figure 22.1**

This pellet appliance has a manufacturer-set minimum low burn rate that must not be altered. It is against federal regulations to alter this setting or otherwise operate this pellet appliance in a manner inconsistent with operating instructions in this manual.

**Follow the detailed instructions found in this section for each step listed in the chart below.**

## C. General Maintenance and Cleaning

### 1. Auto-Clean System Inspection & Cleaning

The auto-clean only dumps ash from the fire pot. The customer is required to clean the appliance in regular intervals depending upon use and fuel quality.

- **Frequency:** Monthly or every ton (aprx. 50 bags) or more frequently depending on the type of fuel
- **By:** Homeowner
  - a. Be sure the wall control screen says OFF and the appliance is allowed to cool.
  - b. Open the firebox door. Inspect the auto-clean springs: **Fig. 23.1**
  - c. Inspect the holes in the fire pot floor for any debris.
    - The holes must be kept clear.
  - d. How often the fire pot cleans itself depends on:
    - The type of fuel you selected on the thermostat wall control
    - How long the appliance burns before satisfying set point on wall the control.
    - Burning biomass fuels may require a more thorough cleaning during the burn season.
  - e. Excessive clinkers will eventually jam the auto-clean system and generate an error message on the wall control.
    - Inspect for any degradation or deformation
    - As the springs heat up and cool down they can lose tension
    - If there is a gap showing above the fire pot bottom, approximately 1/16 inch (1.59mm) or more, it means the springs have lost their tension
    - Lost tension can not keep the floor in the proper position causing ignition problems and fuel falling into the ash pan.
- Call your dealer to replace the springs.

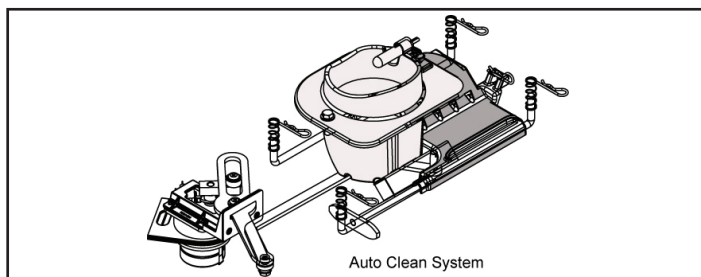

Figure 23.1

<b style="font-size: 1.2em;">WARNING</b>
<p><b>Fire Risk</b></p> <p>Do NOT store fuel:</p> <ul style="list-style-type: none"> <li>• Within space required for loading or ash removal.</li> <li>• Closer than required clearances to combustibles to appliance.</li> </ul>

### 2. Ash Removal from Firebox

- **Frequency:** Weekly or more frequently depending on ash build-up
- **By:** Homeowner

Be sure the wall control screen says OFF and the appliance is allowed to cool.

There must not be any hot ashes in the firebox during cleaning. Frequent cleaning of the ash in the firebox with a vacuum cleaner will help slow down the build-up of ash in the exhaust blower and vent system.

### 3. Cleaning Ash Pan

- **Frequency:** Weekly or every 3-5 bags
- **By:** Homeowner
  - a. Locate the ash pan underneath the fire pot.
  - b. Slide the ash pan straight out.
  - c. Empty into a non-combustible container and re-install ash pan.
  - d. When replacing ash pan push it back until it catches on the 2 side latches.
  - e. Clinkers filling the ash pan will have to be cleaned out more often than ash. **See Disposal of Ashes.**

### 4. Disposal of Ashes

- **Frequency:** As needed
- **By:** Homeowner

Ashes should be placed in a steel container with a tight-fitting lid. The container of ashes should be moved outdoors immediately and placed on a non-combustible floor or on the ground, well away from combustible materials, pending final disposal.

If the ashes are disposed of by burial in soil or otherwise locally dispersed, they should be retained in the closed container until all cinders have thoroughly cooled. Other waste shall not be placed in this container.

<b style="font-size: 1.2em;">WARNING</b>
<p><b>Fire Risk</b></p> <p> Keep combustible materials, gasoline and other flammable vapors and liquids clear of appliance.</p> <ul style="list-style-type: none"> <li>• Do NOT store flammable materials in the appliance's vicinity.</li> <li>• Do NOT use gasoline, lantern fuel, kerosene, charcoal lighter fluid or similar liquids to start or "freshen up" a fire in this appliance.</li> </ul> <p>Keep all such liquids well away from the appliance while it is in use as combustible materials may ignite.</p>

**5. Cleaning Fire pot with Fire pot Clean-Out Tool**

- **Frequency:**  
**Softwood Pellets:** Weekly or every 5 bags  
**Hardwood Pellets:** Weekly or every 3 bags  
**Alternate Fuel:** Daily or every 1 bag
  - **By:** Homeowner
- a. Be sure the wall control screen says OFF and the appliance is allowed to cool.
  - b. It may be necessary to use your fire pot clean-out tool to chip away material that has built up on the sides of the fire pot and to push out any clinkers.
    - Larger clinkers may have to be removed from the top of the fire pot.
    - If the clinker adheres to the sides of the fire pot, you will need to manually clean the fire pot.
  - c. After power is restored, the auto-clean system will recycle and then clean itself.
  - d. The fire pot floor plate must be fully closed when finished.

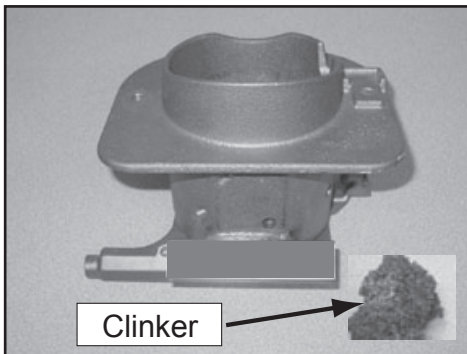



Figure 24.1 - Large Clinker

**6. Cleaning Heat Exchanger, Drop Tube & Exhaust**

- **Frequency:** Monthly or every 1 ton of fuel (aprx. 50 bags).
- **By:** Homeowner

**NOTE:** There are heavy duty vacuum cleaners specifically designed for solid fuel appliance cleaning.

 <b>WARNING</b>	
	<b>Hopper Fire Risk!</b>
	For trouble free use of your pellet appliance you must perform cleaning as called for in these instructions. Not doing so will result in: <ul style="list-style-type: none"><li>• Poor operating performance</li><li>• Smoke spillage into the home</li><li>• Overheating of components</li></ul>
Not properly cleaning your appliance on a regular basis will void your warranty.	

**Tools Needed:** A Shop Vac and generic micro cleaning kit; flat head and Phillips screwdriver; 11/32 Nut-driver or wrench.



Shop Vac\* Example



Micro Cleaning Kit\* Example

*\* Can be purchased at your local hardware store.*

- a. It is necessary to remove the baffle to gain access to the heat exchanger. Follow instructions for baffle removal on page 29.
- b. Vacuum the ash from the heat exchanger with an upholstery brush to remove the majority of the ash. Be sure to vacuum the back of the baffle also. Inspect the drop tube and remove any residue build-up in the drop tube. **Figure 24.3.**

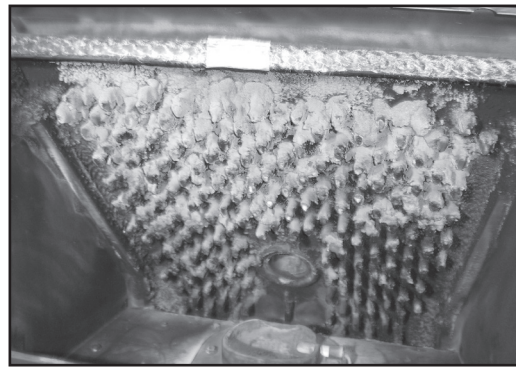

Figure 24.2 - Example of a dirty heat exchanger



Figure 24.3



- c. Assemble the crevice tool from the micro cleaning kit to attach to a Shop Vac. **Figure 25.1.**

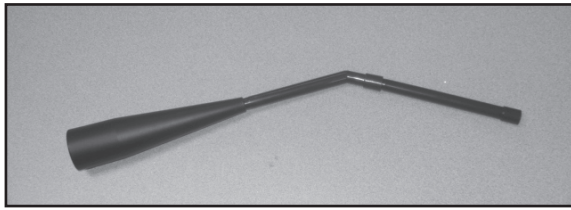

**Figure 25.1**

- d. Use the crevice tool to finish cleaning the heat exchanger fins. It is critical that the 2 exhaust exits at the back of the firebox floor (left and right) be thoroughly cleaned. **Figure 25.2.** There are several ways this can done.

1. Use the crevice tool.
2. Attach a hose 1/2 inch (12.7mm) in diameter and approximately 2 feet (607mm) in length to your vacuum hose.
3. Use a bottle brush and push the ash down to the bottom. Remove the combustion (exhaust) blower and then vacuum out the ash.

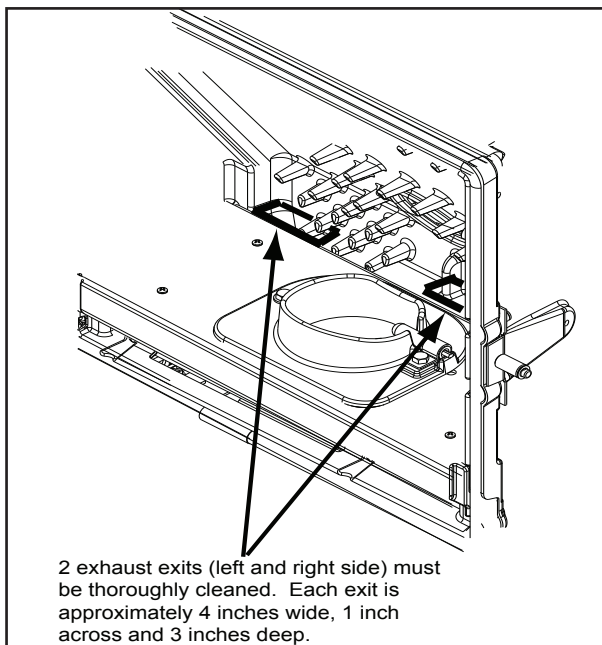
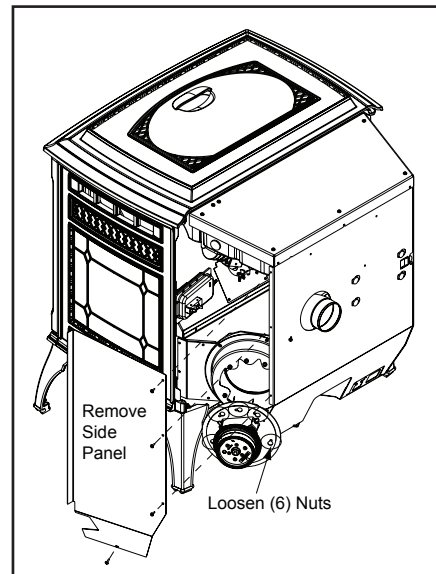

**Figure 25.2**

**NOTE:** It is normal to see a certain amount of wear of the heat exchanger fins. You may notice some flaking and pitting on some of the pins. The heat exchanger system will function as designed with as many as 15 of these pins missing.

- f. Removing the Combustion (Exhaust) Blower

1. The combustion blower is mounted in the bottom right rear of the appliance. **Figure 25.3.**
2. Remove side panel and then using an 11/32 nut driver to loosen all six nuts, but do not remove. Rotate the blower and remove from the housing. **Figure 25.4.**
3. Set the blower on the top of the housing. You do not need to disconnect the wires.
4. Vacuum out the exhaust area. **Figure 25.5.**



**Figure 25.3**

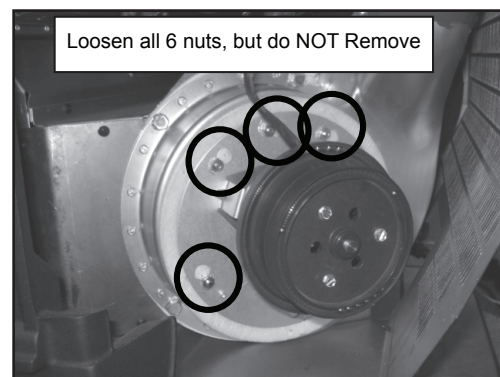

**Figure 25.4**

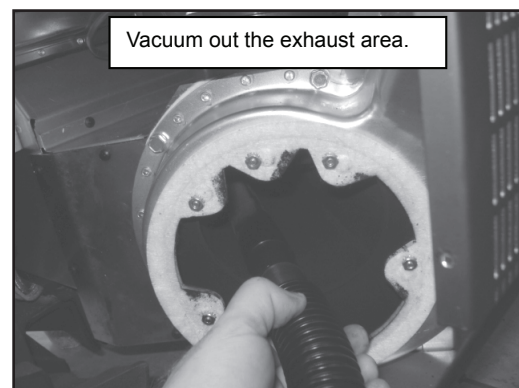

**Figure 25.5**

**7. Cleaning the Hopper**

- **Frequency:** Monthly or after burning 1 ton of fuel, (aprx 50 bags) or when changing fuel types
  - **By:** Homeowner
- a. Be sure the wall control screen says OFF and the appliance is allowed to cool.
  - b. After burning approximately 1 ton of fuel you will need to clean the hopper to prevent sawdust and/or fines build-up.
  - c. A combination of sawdust/fines and pellets on the auger reduces the amount of fuel supply to the fire pot.
  - d. This can result in nuisance shut downs and mis-starts
    - Empty the hopper of any remaining pellets.
    - Vacuum the hopper and feed tube.

**8. Cleaning the Glass**

- **Frequency:** When clear view of fire pot becomes obscure
  - **By:** Homeowner
- a. Be sure the wall control screen says OFF and the appliance is allowed to cool.
  - b. Clean glass with a non-abrasive commercially available cleaner. Wipe down with dry towel.

**9. Door Latch Inspection**

- **Frequency:** Prior to heating season
- **By:** Homeowner

The door latch is non-adjustable but the gasket between the glass and firebox should be inspected periodically to make sure there is a good seal. If the gasket is frayed or damaged, replace with a new one.

**10. Cleaning Exhaust Blower - Requires No Lubrication**

- **Frequency:** Yearly or as needed
  - **By:** Homeowner
- a. Be sure the wall control screen says OFF and the appliance is allowed to cool.
  - b. Use a soft brush and vacuum to clean the propellers.

**11. Cleaning Convection Blower - Requires No Lubrication**

- **Frequency:** Yearly or as needed
  - **By:** Homeowner
- a. Be sure the wall control screen says OFF and the appliance is allowed to cool.
  - b. Use a soft brush and vacuum to clean the propellers.

**12. Cleaning the Top Vent Adapter (if installed)**

- **Frequency:** As Needed
  - **By:** Homeowner
- a. Be sure the wall control screen says OFF and the Appliance is allowed to cool.
  - b. Open the clean out cover. **Figure 26.1.**
  - c. Sweep out any ash build-up.

<b>CAUTION</b>
Handle glass assembly with care.
<b>When cleaning glass door:</b>
<ul style="list-style-type: none"><li>• Avoid striking, scratching or slamming glass.</li><li>• Do NOT clean glass when hot.</li><li>• Do NOT use abrasive cleaners.</li><li>• Use a hard water deposit glass cleaner on white film.</li></ul>
Refer to maintenance instructions.

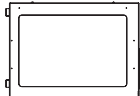
 <b>WARNING</b>

Handle glass doors with care.
<ul style="list-style-type: none"><li>• Inspect the gasket to ensure it is undamaged.</li><li>• Do NOT strike, slam or scratch glass.</li><li>• Do NOT operate appliance with glass door removed, cracked, broken or scratched.</li></ul>

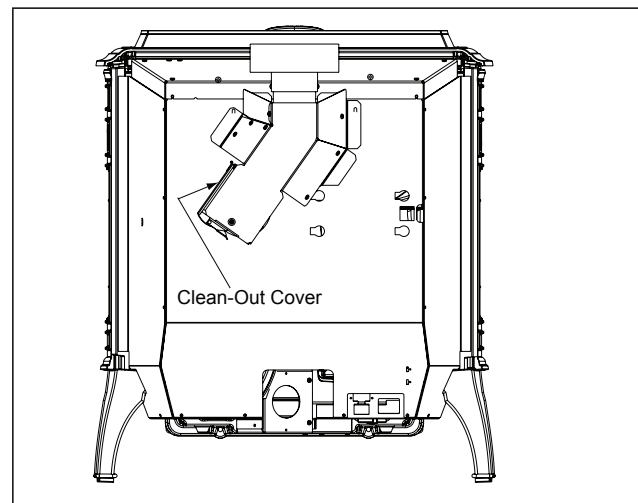

Figure 26.1

**13. Soot and Fly Ash: Formation & Need for Removal in Exhaust Venting System.**

- **Frequency:** Prior to each burn season and after prolonged shut down.
- **By:** Qualified Service Technician/Homeowner

The products of combustion will contain small particles of flash. The flash will collect in the exhaust venting system and restrict the flow of the flue gases. Incomplete combustion, such as occurs during startup, shutdown, or incorrect operation of the room appliance will lead to some soot formation which will collect in the exhaust venting system. The exhaust venting system should be inspected at least once every year to determine if cleaning is necessary.

The venting system may need to be cleaned at least once a year or more often depending upon the quality of your fuel or if there is a lot of horizontal pipe sections. Ash will build up more quickly in the horizontal sections.

**14. Preparing Firebox for Non-Burn Season**

- **Frequency:** Yearly at end of burn season
  - **By:** Homeowner
- a. The appliance must be in complete shutdown and allow the appliance to completely cool down.
  - b. Remove all ash from firebox and vacuum thoroughly.
  - c. Paint all exposed steel, including cast-iron. Use the Touch-Up paint supplied with the appliance or purchase paint from your local dealer. You must use a high-temperature paint made specifically for heating appliances.
  - d. Cleaning the flue at the end of the burn season will prevent corrosives to build-up and damage the flue.
  - e. Outside temperatures should have no affect on the performance of the appliance under freezing conditions.

**15. Creosote Formation: Guidance on minimizing**

- **Frequency:** Periodically during heating season
- **By:** Qualified Service Technician/Homeowner

This chimney should be inspected periodically during the heating season to determine if a creosote build-up has occurred. If a significant layer of creosote has accumulated (3mm or more) it should be removed to reduce the risk of chimney fire.

**NOTE**

**This appliance is required to be cleaned frequently because soot creosote and ash may accumulate.**

**D. Soot or Creosote Fire**

Establish a routine for the fuel, wood burner and firing technique. Check daily for creosote build-up until experience shows how often you need to clean to be safe. Be aware that the hotter the fire the less creosote is deposited, and weekly cleaning may be necessary in the mild weather even though monthly cleaning may be enough in the coldest months. Contact your local municipal or provincial fire authority for information on how to handle a chimney fire.

**In the event of a soot or creosote fire, close the firebox door, exit the building immediately and contact the proper fire authorities.**

**DO NOT under any circumstances re-enter the building.**

**E. High Ash Fuel Content Maintenance**

- **Frequency:** When the ash build-up exceeds the half way point in the fire pot
- **By:** Homeowner

If the ash build-up exceeds the half way point in the fire pot before it automatically cleans, then the fire pot is not being cleaned often enough.

Another symptom is if clinkers are adhering to the sides of the fire pot.

Double check the wall control to ensure the proper setting has been selected for the fuel you are burning. If that is correct, change the setting to “Utility Pellet”.

**NOTE:** You will need to empty the ash pan more frequently if using the “Utility Pellet” setting.

 **WARNING**

**Risk of Fire and Smoke!**

 High ash fuels or lack of maintenance can cause fire pot to overflow. Follow proper shutdown procedure if ash buildup exceeds half way point in fire pot.

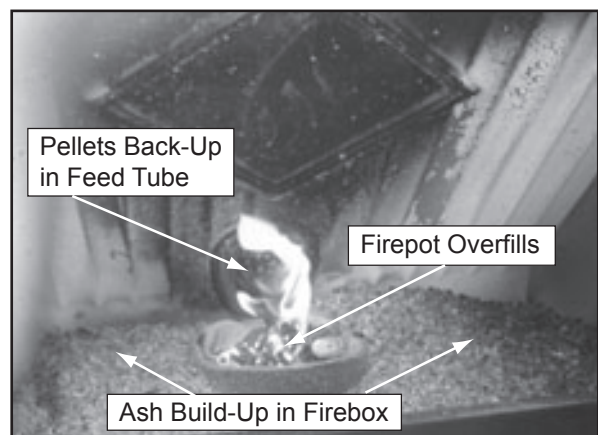

- Failure to do so could result in smoking, sooting and possible hopper fires.



**Figure 27.1**

# 5 Troubleshooting Guide

With proper installation, operation, and maintenance your appliance will provide years of trouble-free service. If you do experience a problem, this troubleshooting guide will assist a qualified service person in the diagnosis of a problem and the corrective action to be taken. This troubleshooting guide can only be used by a qualified service technician.

Error Message	Possible Cause	Corrective Action
	Bad wall control or control board 3 wires have loose connections or installed wrong	Replace wall control or control board Check connections
BAD TC DROP TUBE <i>(TC = Thermocouple)</i>	Drop tube thermocouple is broken or leads are reversed	Check connections Replace thermocouple
BAD TC Fire pot <i>(TC = Thermocouple)</i>	Fire pot thermocouple is broken or leads are reversed	Check connections Replace thermocouple
SNAP DISC TRIPPED	Overheat sensor (snap disc) has tripped  Convection blower may need cleaning	Turn power off to appliance and manually reset snap disc then turn power back on  Clean convection blower if needed
VACUUM SW ERROR <i>(SW = Switch)</i>	Vacuum switch is bad  Vacuum hose is plugged/disconnected	Check connections. Bypass vacuum with jumper wire, if runs, switch is bad. Replace switch  Check vacuum hose
COMB BLOWER JAMMED	Combustion blower is blocked/jammed	Remove blockage Replace blower if necessary Must unplug appliance to clear error
AUGER JAMMED	Auger jammed, feed motor bad	Pull the feed system and inspect Clear jam and Press Retry
MISSED IGNITION	Igniter bad or poor harness connection Out of fuel or fuel is bridging in hopper Faulty fire pot thermocouple connection has shorted. Ash plugging the igniter slot in the fire pot bottom and clear the slot	Check connections, if OK replace igniter Break up bridging pellets. Refill hopper Replace the thermocouple Press Retry Use cleaning tool or a spoon to scrape ash
MIN Fire pot TEMP	Out of fuel	Refill hopper Add handful of pellets to fire pot to prime it Press Retry
MAX DROP TUBE TEMP	Appliance in over-heat condition Flame height set too high Components may need cleaning	Confirm setting matches burning fuel Adjust flame height Clean the firebox, heat exchanger, convection blower, fire pot and ash pan
CONV BLOWER JAMMED	Convection blower blocked/jammed	Remove blockage Replace blower if necessary Must unplug appliance to clear error
CHECK ASHPAN	Auto-clean jammed  Auto-clean switch is bad Linkage has become disconnected	If ashpan is empty, check for a jam. Use a screw driver and firmly push in the fire pot floor holes and flex spring and push toward home to release jam  Replace switch Reconnect linkage
SCREEN GOES BLANK	Static discharge or nearby lightning or Electric fast transients at the input mains	Wait 25 seconds and press any key to refresh the screen.
	Hopper lid not closed all the way Switch is out of adjustment (auger will not function)	Close the lid. If that didn't work replace the switch Adjust or replace switch
	Firebox door is not latched properly	Adjust or replace door switch
	Out of fuel	Check the fuel level, if OK the switch may be out, replace switch

# 6 Service Parts Replacement

## A. Glass Replacement - Door Assembly (Replace with 5mm ceramic glass only)

- Swing open the face and remove the door from the appliance by lifting the door off of the hinge pins and lay on a flat surface face down.
- Using a Phillips head screw driver, remove 4 screws, 2 on the top and 2 on the bottom. Remove metal bracket and then remove the glass. **Figure 29.1.**
- Replace with new glass with gasket.
- Re-attach metal bracket with 4 screws.
- Re-install door over hinge pins and close face.

**⚠ WARNING**

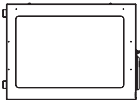

Handle glass doors with care.

- Inspect the gasket to ensure it is undamaged.
- Do NOT strike, slam or scratch glass.
- Do NOT operate appliance with glass door removed, cracked, broken or scratched.

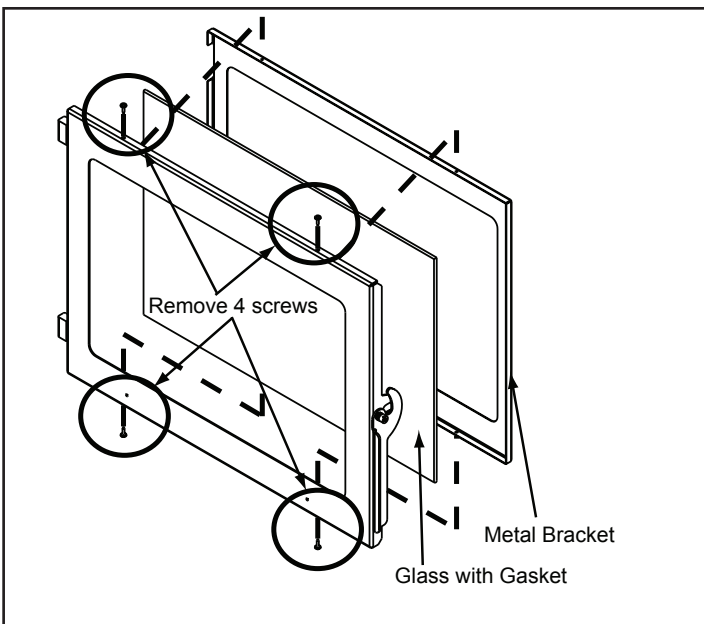



Figure 29.1

**⚠ WARNING**



- Glass is 5mm thick high temperature heat-resistant ceramic glass.
- DO NOT REPLACE with any other material.
- Alternate material may shatter and cause injury.

## B. Baffle Removal

- The appliance must be in complete shutdown, completely cool and the exhaust blower off.
- Open door.
- The baffle is located at the top inside of firebox.
- Remove baffle by placing a flat head screw driver into the slot of the latches located in the upper corners and push down. The bottom of the latch will fall forward off of the post. Lift the baffle up and then out toward you. **Figure 29.2.**
- To replace the baffle, place the 2 locating ears behind the bottom edge and tilt the baffle up and into place.
- The baffle must be centered in the firebox before latching it in place. If it is not centered the latch is trapped between the baffle and side of the firebox instead of latching properly.
- The bottom of the latches will fit over the posts. Push the top of the latch forward to lock latch into place.

**⚠ WARNING**



**Cast iron is a very heavy material.** The baffle is made of cast iron and therefore is heavy and awkward at times to maneuver. Clear and prepare your work area before you begin.

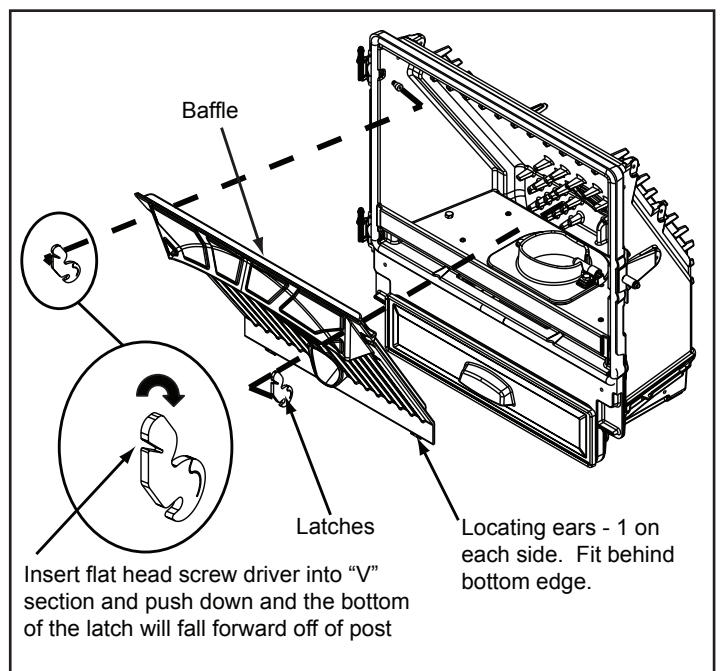

Figure 29.2

### C. Convection Blower Replacement

1. Follow the proper shut down procedures as outlined on **page 22, Section 4.A.**
2. Remove the left and right side panels by removing the 4 screws using a Phillips head screw driver. **Figure 30.1.**
3. Depress the tab on the left side and snap out the power supply. You do not need to disconnect any wires. **Figure 30.1.**
4. Remove the 2 screws at the bottom of the back panel so there will be room to remove the blower. **Figure 30.1**
5. Reach behind the blower and release the latch by pushing the top of the latch towards the blower. **Figure 30.2.**
6. Rock the top of the blower slightly and lift up. The blower will pass around the control board and out the left side of the appliance.
7. Disconnect the wire harness from the bottom of the blower by depressing the tabs on the sides of the connector and then pulling to remove. **Figure 30.1.**
8. Re-connect wire harness to the new blower.
9. Install replacement blower by placing the bottom flange into the opening first then rotate blower up into position.
10. When the blower is properly positioned the latch will engage the notch to hold the blower in place. **Figure 30.3.**
11. Re-secure the back panel, snap the power supply back in and re-secure the side panel(s).

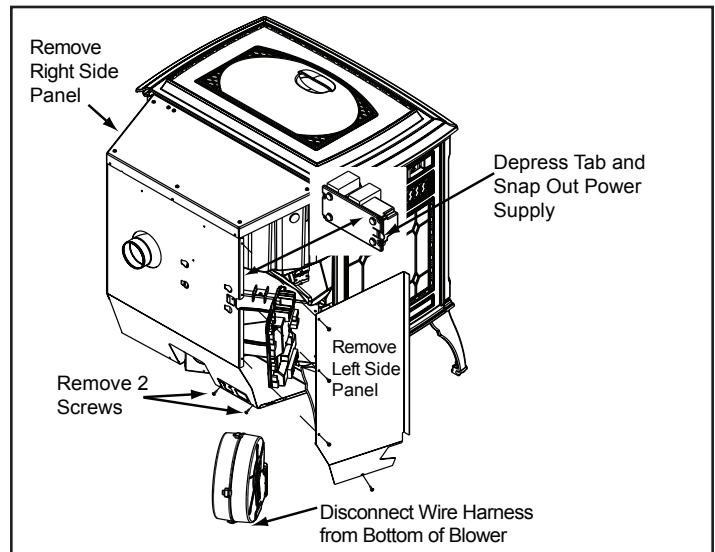

Figure 30.1

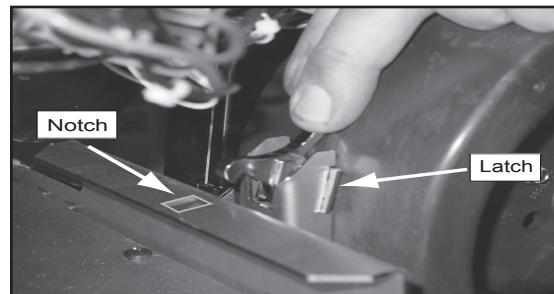

Figure 30.2

### D. Combustion (Exhaust) Blower Replacement

1. Follow the proper shut down procedures as outlined on **page 22, Section 4.A.**
2. Remove the right side panel by removing the 4 screws using a Phillips head screw driver. **Figure 30.4.**
3. It is not necessary or recommended to remove the housing to replace or service the combustion blower. You only need to remove the motor and impeller.
4. Disconnect the wire from the control board connection points #1 and #8. Depress the tab on the connector to disconnect the wire (similar to a telephone connector). **See page 31** for the locations of #1 and #8.
5. Using an 11/32 socket or nut driver, loosen the (6) 8x32 nuts securing the motor and impeller to the housing. Rotate the blower and remove from housing.
6. Holding the black plastic body of the motor, rotate the impeller counter-clockwise until blades line up with opening in the housing and remove motor and impeller.
7. If the gasket between housing and motor is damaged it will have to be replaced. A gasket is included with the replacement blower.
8. Re-install in reverse order.

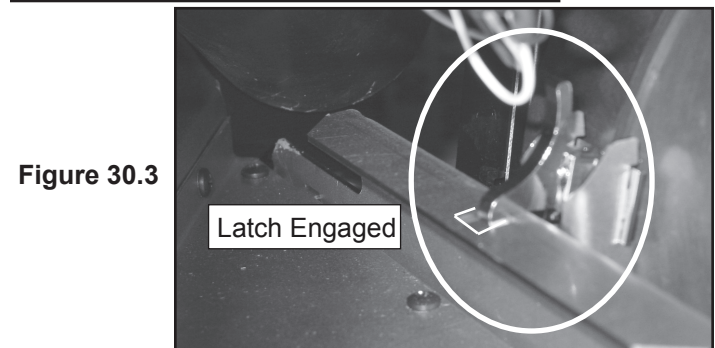

Figure 30.3

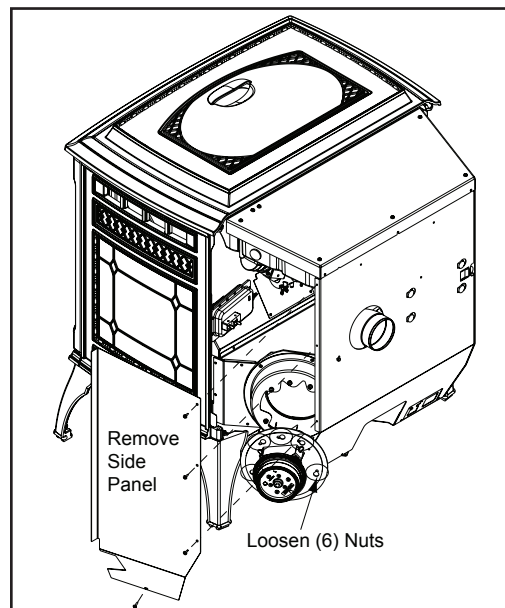

Figure 30.4

# 7 Reference Materials

## A. Component Functions

### 1. Auto-Clean Motor

The auto-clean motor is located under and behind the fire pot on the left side, inside the convection air chamber. It automatically opens and closes the fire pot floor so ashes can fall into the ash pan.

### 2. Auto-Clean Switch

The auto-clean switch is located on top of the auto-clean motor. It communicates to the control board when the fire pot floor is open and when the auto-clean system has completed its cycle and is back in the home (closed) position.

### 3. 12 Volt Battery Back-Up Cable (Optional Accessory)

This is an optional accessory. It will plug into the appliance at the rear of the appliance. An icon will display on the wall control when the appliance has lost main power and is running on battery back-up.

### 4. Combustion (Exhaust) Blower

The combustion (exhaust) blower is mounted in the bottom right rear of appliance. The blower is designed to pull the exhaust from the appliance and push it out through the venting system.

### 5. Control Board

The control board is located on the lower left side of appliance. It controls the functioning of the appliance and communicates with the wall control. The control board can only be opened by an authorized dealer.

### 6. Convection Blower

The convection blower is mounted at the bottom left rear of the appliance. The convection blower pushes heated air through the heat exchange system into the room.

### 7. Door Switch

The door switch is mounted on the right side of the firebox behind the door handle. It senses when the door is open and will display an icon on the wall control, and will turn off the auto-clean system and feed motor for safety.

### 8. Feed System

The feed system is located on the right side of the appliance and can be removed as an entire assembly. The assembly includes the feed motor, mounting bracket, bearing and feed spring (auger). The hollow feed spring (auger) pulls pellets up the feed tube from the hopper area and drops them down the feed chute into the fire pot.

### 9. Fire pot

The fire pot is made of high quality ductile iron. The floor of the fire pot automatically opens for cleaning and is operated by the auto-clean fire pot system. The floor needs to return to a completely closed position or the appliance will not operate properly.



When describing the location of a component, it is always **AS YOU FACE THE FRONT OF THE APPLIANCE**.

### 10. Fuses

There are three fuses. Two fuses are located on the inside of the control board. One fuse is AC and operates the igniter and the other fuse is DC and operates all of the other components. The third fuse is located in the power supply. A fuse will blow should a short occur and shut off power to the appliance. The fuses can only be replaced by an authorized dealer.

### 11. Heat Exchanger

The heat exchanger is located behind the baffle and it transfers heat from the exhaust system into the convection air chamber. Remove the cast iron baffle to access the heat exchanger.

### 12. Hopper Lid Switch

The hopper lid switch is located on the right side inside the hopper. It senses whether the hopper lid is open and displays an icon on the wall control and will turn off the feed motor.

### 13. Igniter (Heating Element)

The igniter is mounted on the base of the fire pot. Combustion air travels over the red hot igniter creating super heated air that ignites the pellets or other fuels.

### 14. Low Fuel Indicator

The low fuel indicator is attached to the left side of the hopper. It senses the amount of fuel in the hopper and will display an icon on the wall control.

300 Watt Igniters come installed in brand new Mt. Vernon AE appliances and are for pellet fuel only. The 380 Watt Igniter is required for burning multi-grain fuels and is included in the component pack. Multi-fuels include, corn, sunflower seeds, and wheat.

### 15. Optical Switch for the Auger

The optical switch is located on top of the feed system and communicates to the wall control that the auger is spinning or if it has stopped.

### 16. Power Receptacle

The power receptacle is located on the lower rear of the appliance. Check the wall receptacle for 120 volt, 60 Hz (standard current). Make sure the outlet is grounded and has the correct polarity. A good quality surge protector is highly recommended to protect the electronics.

**17. Power Supply**

The power supply is located at the rear of the appliance. It converts 120 volt AC current to 15 volt DC current to power the appliance.

**18. Overheat Sensor (Snap Disc)**

The overheat sensor is mounted on the back of the drop tube in the center of the appliance and has a reset button. To access it remove the right side panel. If the fire tries to burn back into the feed system or push exhaust up the feed tube, this sensor will shut the appliance down, however the wall control will still display messages. This sensor must be manually re-set. Disconnect power before resetting.

**19. Thermocouple - Fire pot**

This thermocouple is located on top of the fire pot inside the thermocouple cover (ceramic protection tube). The thermocouple sends a millivolt signal to the control board telling the control board there is a fire in the fire pot.

**20. Thermocouple - Drop Tube**

This thermocouple is located on the bottom of the drop tube on the right side and attached with a wing nut. It turns the convection blower on and off, varies the speed of the convection blower and will shut down appliance if internal heat exceeds set temperature.

**21. Vacuum Switch**

The vacuum switch is located on the right side of the appliance under the feed motor behind right side panel and connects to the drop tube with a hose. This switch turns the feed system on when vacuum is present in the firebox. The vacuum switch is a safety device to shut off the feed motor if the exhaust or the heat exchanger system is dirty, plugged or if the firebox door is open.

**22. Wall Control Thermostat**

The appliance is designed to run on a custom designed 3.3 volt DC thermostat wall control. It will not operate on any other wall control. Refer to the instructions supplied with the appliance located in the component pack.

**23. Wiring Schematic for Power Supply**

See Figure 32.1 below.

**24. Wiring Schematic for Control Board**

See Figure 32.2 below.

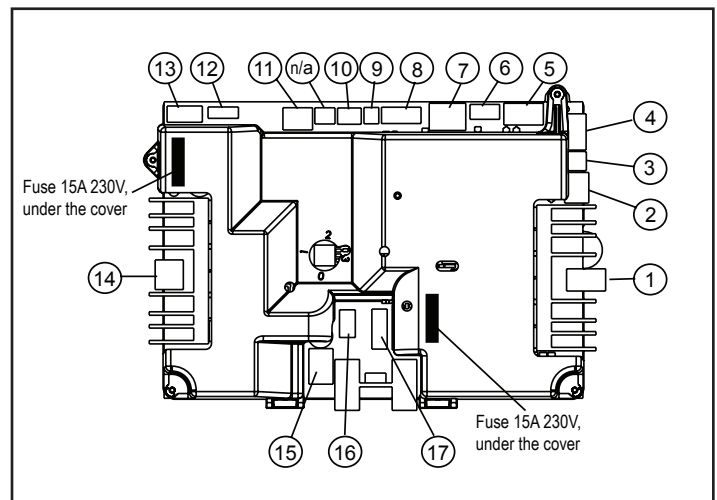
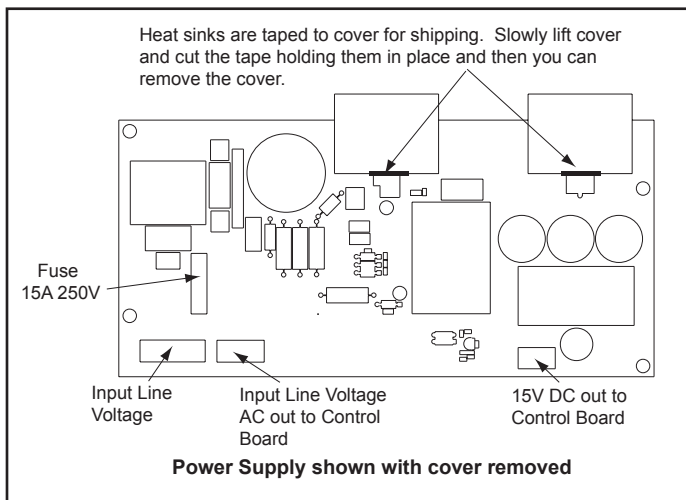

Figure 32.1 - Power Supply

Figure 32.2 - Control Board

#	Description
1	Combustion Blower
2	Auto-Clean System
3	Feed/Auger Motors
4	Hopper/Door Switches
5	Auger/Auto-Clean/Vacuum Switches
6	Low Fuel

#	Description
7	Thermostat Wall Control
8	Combustion Blower (feedback)
9	Fire pot Thermocouple
10	Drop Tube Thermocouple
n/a	Not Used
11	Convection Blower (feedback)

#	Description
12	Igniter
13	AC Power In for Igniter
14	Convection Blower Power
15	Overheat Sensor (Snap Disc)
16	DC Power In from Power Supply
17	12 Volt Battery Back-up



**B. Component Locations**

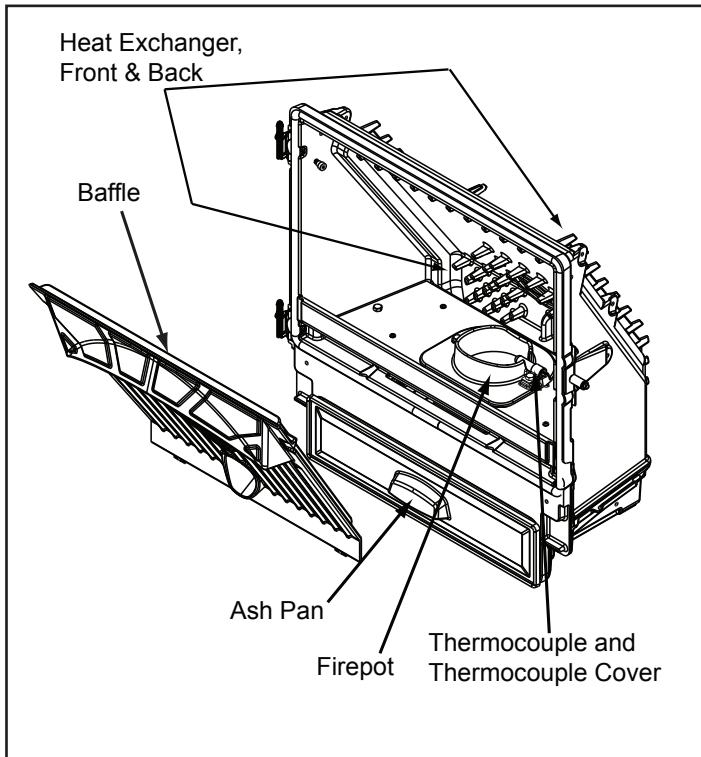

Figure 33.1

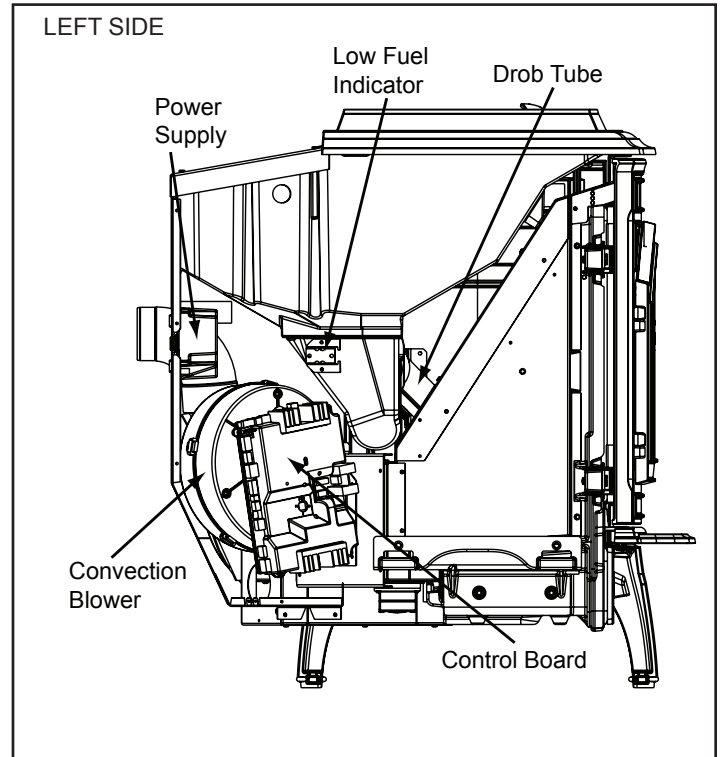

Figure 33.2

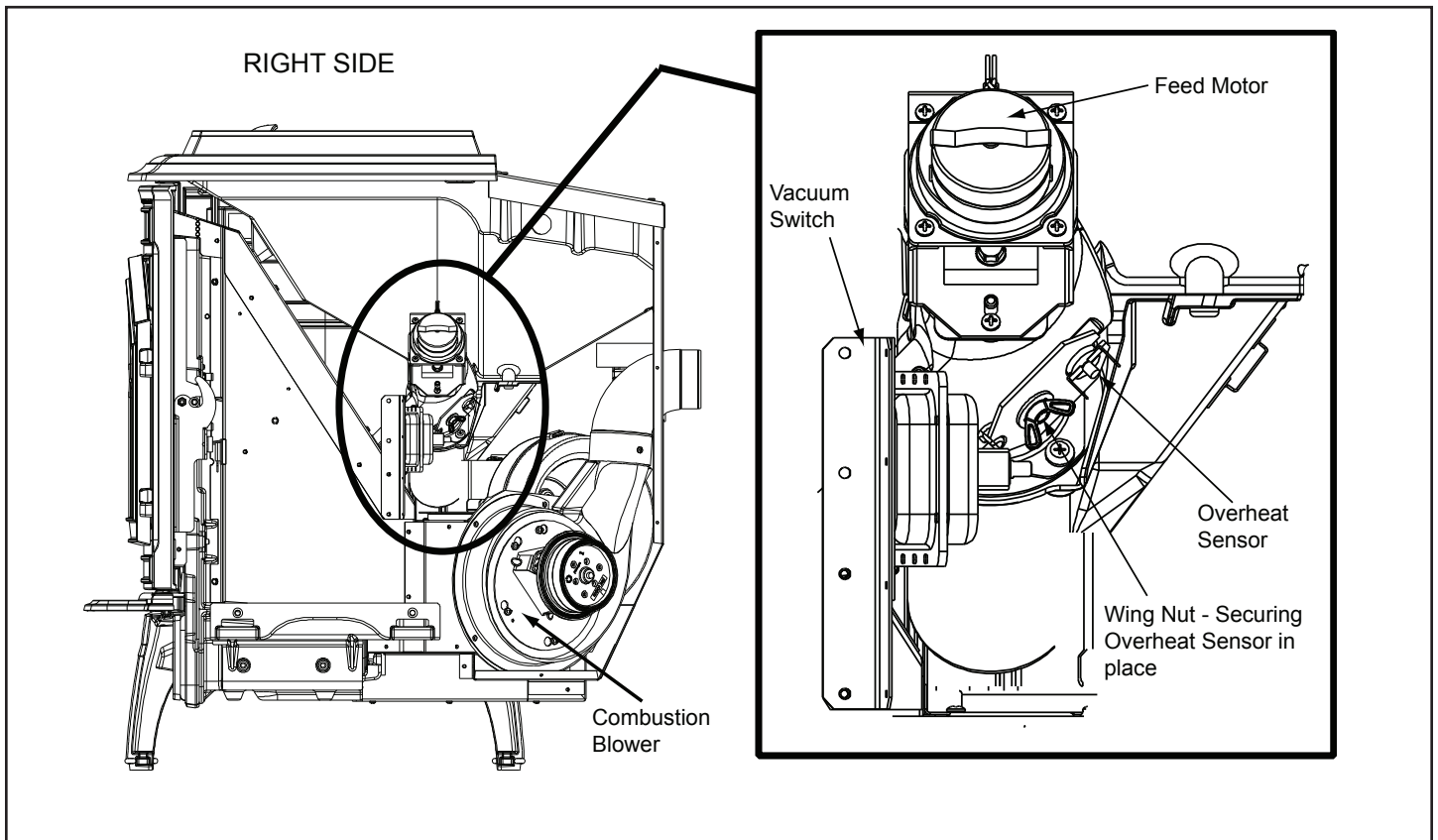

Figure 33.3

Figure 33.4

C. Exploded Drawings

**QUADRA-FIRE** Service Parts

**MT VERNON-AE**

Pellet Stove

Beginning Manufacturing Date: Sept. 2006  
Ending Manufacturing Date: Active

MTVERNON-AE-CSB, MTVERNON-AE-MBK, MTVERNON-AE-PMH, MTVERNON-AE-PBK, MTVERNON-PFT, MTVERNON-PDB  
MTVERNON-AE-CWL (Sept 2006 thru June 2011)

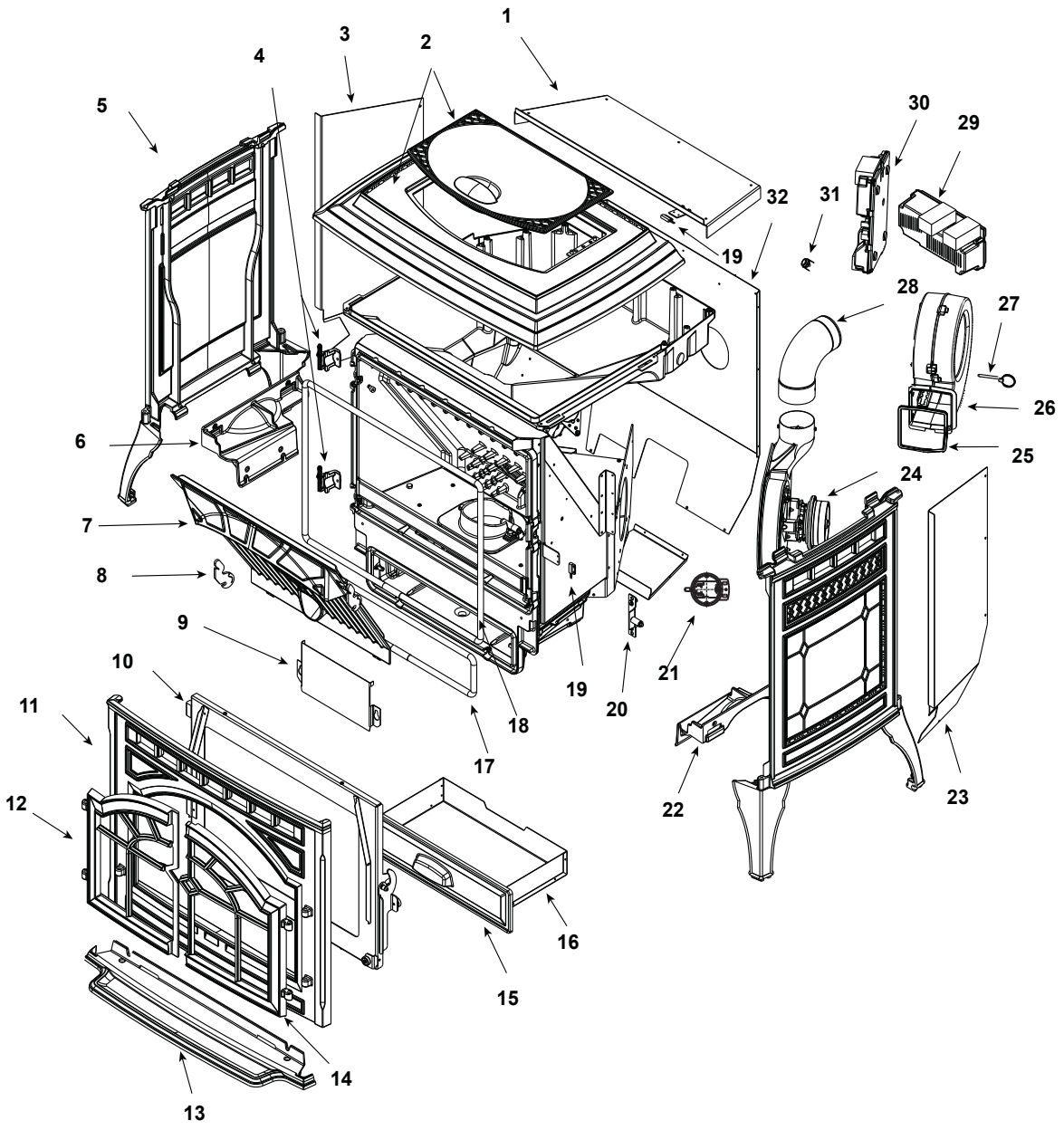

Part number list on following page.

05/17

Beginning Manufacturing Date: Sept. 2006  
Ending Manufacturing Date: Active

**D. Service Parts List**

IMPORTANT: THIS IS DATED INFORMATION. Parts must be ordered from a dealer or distributor. **Hearth and Home Technologies does not sell directly to consumers.** Provide model number and serial number when requesting service parts from your dealer or distributor.



**Stocked at Depot**

ITEM	DESCRIPTION	COMMENTS	PART NUMBER	
1	Hopper Top		7034-169	
<p><b>#2 Hopper Lid Assembly</b></p>				
2.1	Hopper Lid	Matte Black	7034-157MBK	
		Porcelain Black	7034-157PBK	
		Porcelain Dark Blue	7034-157PDB	
		Porcelain Frost	7034-157PFT	
		Sienna Bronze	7034-157CSB	
		Willow	7034-157CWL	
		Mahogany	7034-157PMH	
	Gasket, Hopper Lid	10 FT	7000-320/10	
	Gasket, Hopper, Front/Back		SRV7034-236	
2.2	Magnet. Round		SRV7000-140	Y
2.3	Hinge Arm Right - Hopper Lid Bracket		7034-160	
	Hinge Arm Left - Hopper Lid Bracket		7034-161	
2.4	Top	Matte Black	7034-155MBK	
		Porcelain Black	7034-155PBK	
		Porcelain Dark Blue	7034-155PDB	
		Porcelain Frost	7034-155PFT	
		Sienna Bronze	7034-155CSB	
		Mahogany	7034-155PMH	
2.5	Hinge Pin - Holds Hopper Lid to Top		SRV7034-159	
2.6	Hinge Retainer - Holds Hopper Lid to Top		SRV7034-163	
2.7	Screw, 1/4 - 20 X 5/8	Pkg of 10	7000-426/10	Y
3	Shroud Left		7034-172	
4	Hinge Male		SRV7034-138	

Additional service part numbers appear on following page.

Beginning Manufacturing Date: Sept. 2006  
Ending Manufacturing Date: Active

IMPORTANT: THIS IS DATED INFORMATION. Parts must be ordered from a dealer or distributor. **Hearth and Home Technologies does not sell directly to consumers.** Provide model number and serial number when requesting service parts from your dealer or distributor.



**Stocked  
at Depot**

ITEM	DESCRIPTION	COMMENTS	PART NUMBER	
5	Side (Interchangeable)	Matte Black	7005-107MBK	
		Porcelain Black	7005-107PBK	
		Porcelain Dark Blue	7005-107PDB	
		Porcelain Frost	7005-107PFT	
		Sienna Bronze	7005-107CSB	
		Willow	7005-107CWL	
		Mahogany	7005-107PMH	
6	Side Mount Left		7034-128	
7	Baffle		SRV7034-263	Y
8	Latch, Baffle		SRV7034-149	
9	Intake Shield		7034-224	Y

**#10 Door Assembly**

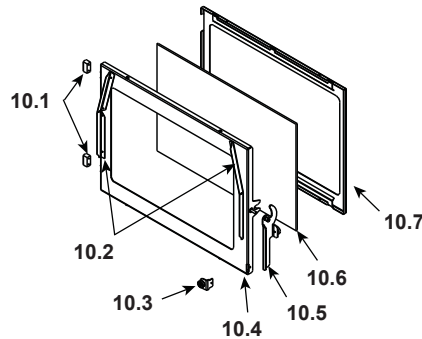

10	Door Assembly		7034-006	
10.1	Hinge, Female		SRV450-2910	
10.2	Door Air Deflector		7034-185	
10.3	Magnet Bracket Assembly		7034-008	
	Magnet Round		SRV7000-140	Y
10.4	Door Frame Assembly		7034-026	
10.5	Door Latch Assembly		7034-039	
10.6	Glass Assembly - 21 in. W x 14 in. H		7034-007	Y
	Gasket, Channel 3 Mm X 32 - Field Cut To Size	10 Ft	7000-377/10	Y
10.7	Glass Retainer		7034-136	
11	Front, Face	Matte Black	7005-108MBK	
		Porcelain Black	7005-108PBK	
		Porcelain Dark Blue	7005-108PDB	
		Porcelain Frost	7005-108PFT	
		Sienna Bronze	7005-108CSB	
		Willow	7005-108CWL	
		Mahogany	7005-108PMH	

Additional service part numbers appear on following page.

Beginning Manufacturing Date: Sept. 2006

Ending Manufacturing Date: Active

IMPORTANT: THIS IS DATED INFORMATION. Parts must be ordered from a dealer or distributor. **Hearth and Home Technologies does not sell directly to consumers.** Provide model number and serial number when requesting service parts from your dealer or distributor.



Stocked at Depot

ITEM	DESCRIPTION	COMMENTS	PART NUMBER	
12	Door Left	Matte Black	7005-110MBK	
		Porcelain Black	7005-110PBK	
		Porcelain Dark Blue	7005-110PDB	
		Porcelain Frost	7005-110PFT	
		Sienna Bronze	7005-110CSB	
		Willow	7005-110CWL	
		Mahogany	7005-110PMH	
13	Ash Lip	Matte Black	7005-111MBK	
		Porcelain Black	7005-111PBK	
		Porcelain Dark Blue	7005-111PDB	
		Porcelain Frost	7005-111PFT	
		Sienna Bronze	7005-111CSB	
		Willow	7005-111CWL	
		Mahogany	7005-111PMH	
14	Door Right	Matte Black	7005-109MBK	
		Porcelain Black	7005-109PBK	
		Porcelain Dark Blue	7005-109PDB	
		Porcelain Frost	7005-109PFT	
		Sienna Bronze	7005-109CSB	
		Willow	7005-109CWL	
		Mahogany	7005-109PMH	
15	Ash Pan Door		7034-133	
16	Ash Pan Assembly		SRV7034-069	
	Roller Catch	Pre 00700109156	SRV7000-494	Y
	Twin Ball catch	Post 00700109156	SRV7000-532	Y
17	Gasket, Rope, Ash Door		SRV7034-178	Y
18	Gasket, Door Rope		SRV7034-177	Y
19	Magnetic Switch		SRV7000-375	Y
20	Latch Bracket Assembly		SRV7034-049	Y
21	Vacuum Switch		SRV7000-531	Y
22	Side Mount Right		7034-126	
23	Shroud Right		SRV7034-171	
24	Combustion Blower Assembly		7034-033	Y
	Gasket, Blower, Combustion (between...)	...Housing & Stove	SRV7000-332	Y
	Gasket, Motor, Blower, Combustion (between...)	...Housing & Motor	SRV7000-714	Y
		Pkg of 10	SRV7000-714/10	Y
25	Gasket, Blower, Convection		SRV7000-329	
26	Convection Blower		SRV7000-260	Y

Additional service part numbers appear on following page.

Beginning Manufacturing Date: Sept. 2006  
Ending Manufacturing Date: Active

IMPORTANT: THIS IS DATED INFORMATION. Parts must be ordered from a dealer or distributor. **Hearth and Home Technologies does not sell directly to consumers.** Provide model number and serial number when requesting service parts from your dealer or distributor.



**Stocked at Depot**

ITEM	DESCRIPTION	COMMENTS	PART NUMBER	
27	Detent Pin	Pre 00700103644	7000-376	
	Elbow Latch	Post 00700103644	7000-393	
28	Exhaust Transition Assembly		SRV7034-139	
29	Power Supply Assembly		SRV7000-443	Y
	Fuse 5A Slow IEC	Pkg of 10	7000-490/10	Y
30	Control Board Assembly		SRV7000-456	Y
	Fuse 15A Slow Iec Glass	Pkg of 10	7000-491/10	Y
31	Snap Disc, Manual Reset		SRV230-1290	Y
32	Rear Shroud		7034-170	

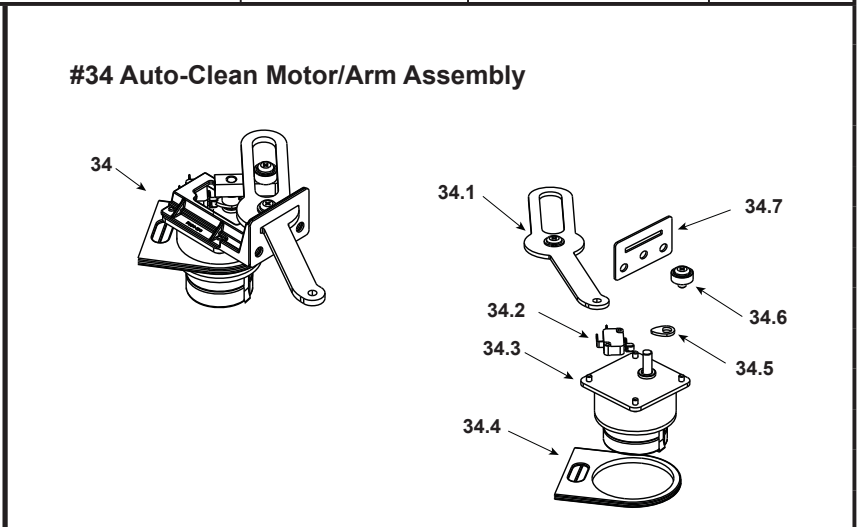
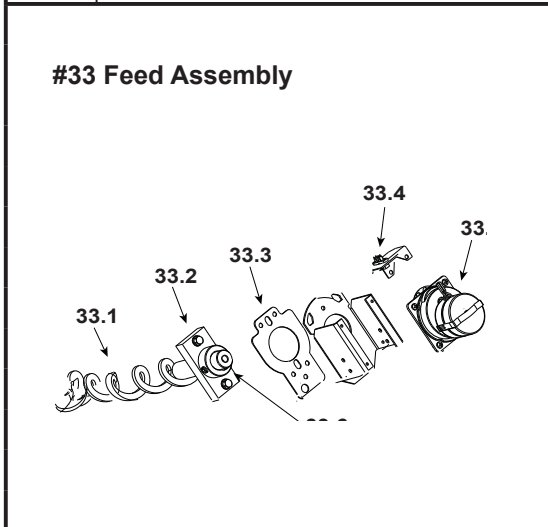

33	Feed Assembly		SRV7034-004	Y
33.1	Feed Spring Assembly (Only)		SRV7001-046	Y
33.2	Bearing, Feed System, Nylon		SRV7000-598	Y
33.3	Gasket, Feed Motor		SRV7034-144	
33.4	Optical Switch Assembly		SRV7034-038	Y
33.5	Feed Motor DC		SRV7000-313	Y
33.6	Collar, Set, 7/8		229-0520	
34	Auto-Clean Motor/Arm Assembly		SRV7034-020	Y
34.1	Auto-Clean Lever		7034-158	Y
34.2	Micro Switch No		SRV7000-327	Y
34.3	Gear Motor 12V		SRV7000-502	Y
34.4	Grommet, Motor, Auto-Clean		7034-188	Y
34.5	Cam, Switch, Auto-Clean		SRV7034-187	Y
34.6	Bearing		7000-333	Y
34.7	Gasket, Auto-Clean		SRV7034-165	Y

Additional service part numbers appear on following page.

Beginning Manufacturing Date: Sept. 2006  
Ending Manufacturing Date: Active

#35 Firepot Riser Assembly

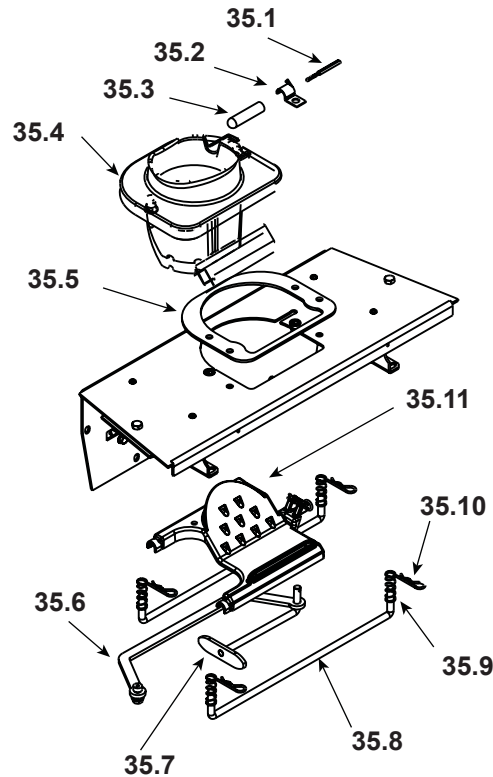

IMPORTANT: THIS IS DATED INFORMATION. Parts must be ordered from a dealer or distributor. **Hearth and Home Technologies does not sell directly to consumers.** Provide model number and serial number when requesting service parts from your dealer or distributor.



Stocked at Depot

ITEM	DESCRIPTION	COMMENTS	PART NUMBER	
35	Firepot Riser Assembly		SRV7034-002	
35.1	Thermocouple, K		SRV7034-247	Y
35.2	Half Clip - Thermocouple Holder		7000-321	
35.3	Thermocouple Protection Tube - Thermocouple Cover		SRV7034-186	Y
35.4	Firepot Assembly, Upper		SRV7034-072B	Y
35.5	Gasket, Firepot		SRV7034-190	Y
35.6	Auto-Clean Link Arm		7034-176	Y
35.7	Plow Weldment, Auto-Clean		SRV7034-024	Y
35.8	Rail, Auto-Clean		SRV7034-152	Y
35.9	Spring	Pkg of 4	7000-513/4	Y
35.10	Hitch Pin Clip 3/32	Pkg of 10	7000-374/10	Y
35.11	Firepot Bottom		SRV7034-153	Y
	Auto-Clean Bottom Assembly (Includes Auto Clean Plow Weldment, Link Arm, Firepot Bottom & Hitch Pin Clip)		7034-021	Y
	Firepot Riser Clamp Assembly (Includes Clamp and Hex Nut)		7034-012	

Additional service part numbers appear on following page.

IMPORTANT: THIS IS DATED INFORMATION. Parts must be ordered from a dealer or distributor. **Hearth and Home Technologies does not sell directly to consumers.** Provide model number and serial number when requesting service parts from your dealer or distributor.



**Stocked at Depot**

ITEM	DESCRIPTION	COMMENTS	PART NUMBER	
	Bracket, Control Board		7034-212	
	Bracket, Door Switch		7034-215	
	Bracket, Hopper Switch		7034-216	
	Bracket, Snap Disc		7034-150	
	Bracket, Vacuum Switch		7034-211	
	Component Pack Assembly	Matte Black	SRV7034-034	
		Porcelain Black	SRV7034-079	
		Porcelain Dark Blue	SRV7034-078	
		Porcelain Frost	SRV7034-080	
		Sienna Bronze	SRV7034-035	
		Mahogany	SRV7034-037	
	Cleanout Tool		414-1140	Y
	Leveling Assembly		7000-000	
	Paint Touch-Up	Matte Black	812-0910	
		Mahogany	855-1450	
		Sienna Bronze	TOUCHUP-CSB	
		Willow	TOUCHUP-CWL	
	Power Cord		812-1180	Y
	Thermostat Wire 3 Cond		SRV7000-409	Y
	Wall Control		SRV7000-549	Y
	Face Plate - Located Behind ARS Door		7034-124	
	Fuel Level Sensor		SRV7000-523	Y
	Gasket, Exhaust	3.13" X 4.75"	SRV7034-109	
	Heating Element Assembly 18" (Loop Igniter), 380 Watt		SRV7000-462	Y
		Pkg of 10	SRV7000-462/10	Y
	Heating Element Assembly 18", 120 VAC, 300 Watt, ( <b>Wood Pellet Fuel Only</b> )		SRV7000-647	Y
		Pkg of 10	SRV7000-647/10	Y
	Washer, 1/4 Sae	Pkg of 24	28758/24	Y
	Wing Thumb Screw 8-32 X 1/2	Pkg of 24	7000-223/24	Y
	Hinge Pin		844-5750	Y
	Hinge Pin (Rivet) Button Head	Pkg of 25	25272/25	Y
	Thermocouple K, Ring Mount - Drop Tube		SRV7000-381	Y
	Paint, 12 oz Can	Sienna Bronze/Espresso	PAINT1-CSB/CES	
		Willow/Tuscan Olive	PAINT1-CWL/CTO	
	Vacuum Hose - Field Cut to Size	3 Ft	SRV7000-373	Y

Additional service part numbers appear on following page.



Beginning Manufacturing Date: Sept. 2006

Ending Manufacturing Date: Active

IMPORTANT: THIS IS DATED INFORMATION. Parts must be ordered from a dealer or distributor. **Hearth and Home Technologies does not sell directly to consumers.** Provide model number and serial number when requesting service parts from your dealer or distributor.



**Stocked at Depot**

ITEM	DESCRIPTION	COMMENTS	PART NUMBER	
	Wire Clip	Pkg of 10	7000-400/10	Y
	Wire Harness Aug/Ac/Vac		SRV7034-191	Y
	Wire Harness Battery Backup		SRV7034-202	Y
	Wire Harness Convection Blower		SRV7034-219	Y
	Wire Harness Door/Hopper		SRV7034-192	Y
	Wire Harness Ignitor		SRV7034-273	Y
	Wire Harness Power Out Ac	AC Current	SRV7034-220	Y
	Wire Harness Power Out Dc	DC Current	SRV7034-221	Y
	Wire Harness Power Supply Receptacle		SRV7034-233	Y
	Wire Harness Snap Disc		SRV7034-193	Y
	Wire Harness Thermostat		SRV7034-200	Y
ACCESSORIES				
	12 Volt Power Cord		12VCORD-AE	Y
	Collar, Offset, Top Vent		812-3570	
	Damper, 3 Inch - Tall Vertical Installs Only		PEL-DAMP3	Y
	Damper, 4 Inch - Tall Vertical Installs Only		PEL-DAMP4	
	Firescreen	<b>No Longer Available</b>	SCR-7005	
	Log Set, (Sold as Set only)	2 Pc	LOGS-60-AE-B	Y
	Outside Air Kit		OAK-3	
	Top Vent Adapter		TPVNT-3	
	Vent Adapter, 3-4"		811-0720	
	Vent Adapter, 90, Cleanout		811-0610	
	Vent Adapter, Rear		811-0620	
	Warming Shelves	<b>No Longer Available</b>	844-9780	
		Porcelain Black	WSLG-PBK	
		Porcelain Dark Blue	WSLG-PDB	
		Porcelain Frost	WSLG-PFT	
		Sienna Bronze	WSLG-CSB	
		Willow	WSLG-CWL	
		<b>No Longer Available</b>	844-9810	
FASTENERS				
	Avk Rivnut Repair Kit - 1/4-20 & 3/8-16 Rivnut Tools		RIVNUT-REPAIR	Y
	Button Head 1/4-20 X .5	Pkg of 20	32328/20	Y
	Nut, Ser Flange Small 1/4-20	Pkg of 24	226-0130/24	Y
	Screw, 1/4-20 X 3/8 Phillips Button Head	Pkg of 24	7000-401/24	Y
	Screw 1/4-20 X 5/8 Phillips Pan Head	Pkg of 24	7000-398/24	Y
	Screw, Pan Head Philips 8-32 X 3/8	Pkg of 40	225-0500/40	Y
	Screw, Sheet Metal #8 X 1/2 S-Grip	Pkg of 40	12460/40	Y
	Wing Thumb Screw 8-32 X 1/2	Pkg of 24	7000-223/24	Y



**CONTACT INFORMATION**

Hearth & Home Technologies  
352 Mountain House Road  
Halifax, PA 17032  
Division of HNI INDUSTRIES

**Please contact your Quadra-Fire dealer with any questions or concerns.  
For the number of your nearest Quadra-Fire dealer  
log onto [www.quadrafire.com](http://www.quadrafire.com)**

**CAUTION**



Important operating and maintenance instructions included.

**DO NOT DISCARD THIS MANUAL**

• Read, understand and follow these instructions for safe installation and operation.

• Leave this manual with party responsible for use and operation.



**We recommend that you record the following pertinent information for your heating appliance.**

Date purchased/installed: \_\_\_\_\_

Serial Number: \_\_\_\_\_ Location on appliance: \_\_\_\_\_

Dealership purchased from: \_\_\_\_\_ Dealer phone: 1(\_\_\_\_) \_\_\_\_ - \_\_\_\_\_

Notes: \_\_\_\_\_

\_\_\_\_\_

\_\_\_\_\_

\_\_\_\_\_

This product may be covered by one or more of the following patents: (United States) 5341794, 5263471, 6688302, 7216645, 7047962 or other U.S. and foreign patents pending.

