

**Models:**  
**GO24MTCH, GO30MTCH**  
**Grand Oak Match Light**  
**Gas Log Sets**



Installation and service of this appliance should be performed by qualified personnel. Hearth & Home Technologies suggests NFI certified or factory-trained professionals, or technicians supervised by an NFI certified professional.



Check with your local building code agency before you begin installation to ensure compliance with local codes, including the need for permits and follow-up inspections. If you encounter any problems regarding code approvals, or if you need clarification of any of the instructions contained here, contact the Technical Services Dept., Hearth & Home Technologies Inc., [www.hearthnhome.com](http://www.hearthnhome.com).

<b>CAUTION</b>		
	<p><b>DO NOT DISCARD THIS MANUAL</b></p> <ul style="list-style-type: none"> <li>• Important operating and maintenance instructions included.</li> <li>• Read, understand and follow these instructions for safe installation and operation.</li> <li>• Leave this manual with party responsible for use and operation.</li> </ul>	

<b>⚠ WARNING</b>
<div style="display: flex; align-items: center;"> <p><b>If the information in these instructions is not followed exactly, a fire may result causing property damage, personal injury, or death.</b></p> </div> <ul style="list-style-type: none"> <li>• Do not store or use gasoline or other flammable vapors and liquids in the vicinity of this or any other appliance.</li> <li>• <b>What to do if you smell gas:</b> <ul style="list-style-type: none"> <li>- Do not try to light any appliance.</li> <li>- Do not touch any electrical switch. Do not use any phone in your building.</li> <li>- Immediately call your gas supplier from a neighbor's phone. Follow the gas supplier's instructions.</li> <li>- If you cannot reach your gas supplier, call the fire department.</li> </ul> </li> <li>• Installation and service must be performed by a qualified installer, service agency, or the gas supplier.</li> </ul>

<b>⚠ WARNING</b>
<div style="display: flex; align-items: center;"> <p><b>HOT! DO NOT TOUCH. SEVERE BURNS MAY RESULT. CLOTHING IGNITION MAY RESULT.</b></p> </div> <p>Glass and other surfaces are hot during operation and cool down.</p> <ul style="list-style-type: none"> <li>• Keep children away.</li> <li>• CAREFULLY SUPERVISE children in same room as appliance.</li> <li>• Alert children and adults to hazards of high temperatures.</li> <li>• Do NOT operate with protective barriers removed.</li> <li>• Keep clothing, furniture, draperies and other combustibles away.</li> </ul>

<p><b>In the Commonwealth of Massachusetts:</b></p> <ul style="list-style-type: none"> <li>• This appliance must be installed by a licensed plumber or gas fitter.</li> <li>• The chimney flue damper, when used with gas logs, will be welded open or completely removed.</li> <li>• A CO detector shall be installed in the room where the appliance is installed.</li> </ul>
---

**Read this manual before installing or operating this appliance.  
Please retain this owner's manual for future reference.**

***Congratulations***

Congratulations on selecting a Hearth & Home Technologies gas log set—an elegant and clean alternative to burning wood. The Hearth & Home Technologies gas log set you have selected is designed to provide the utmost in safety, reliability, and efficiency.

As the owner of this new gas log set, you'll want to read and carefully follow all of the instructions contained in this owner's manual. Pay special attention to all cautions and warnings.

This owner's manual should be retained for future reference. We suggest you keep it with your other important documents and product manuals.

The information contained in this owner's manual, unless noted otherwise, applies to all models and gas control systems.

Your new gas log set will give you years of durable use and trouble-free enjoyment. Welcome to the Hearth & Home Technologies family of appliance products!

<b>Homeowner Reference Information</b>	<i>We recommend that you record the following pertinent information about your gas log set:</i>
Model Name: _____	Date purchased/installed: _____
Serial Number: _____	Location on appliance: _____
Dealership purchased from: _____	Dealer phone: _____
Notes: _____	
_____	
_____	

**Listing Label Information/Location**

The model information regarding your specific gas log set can be found on the rating plate.

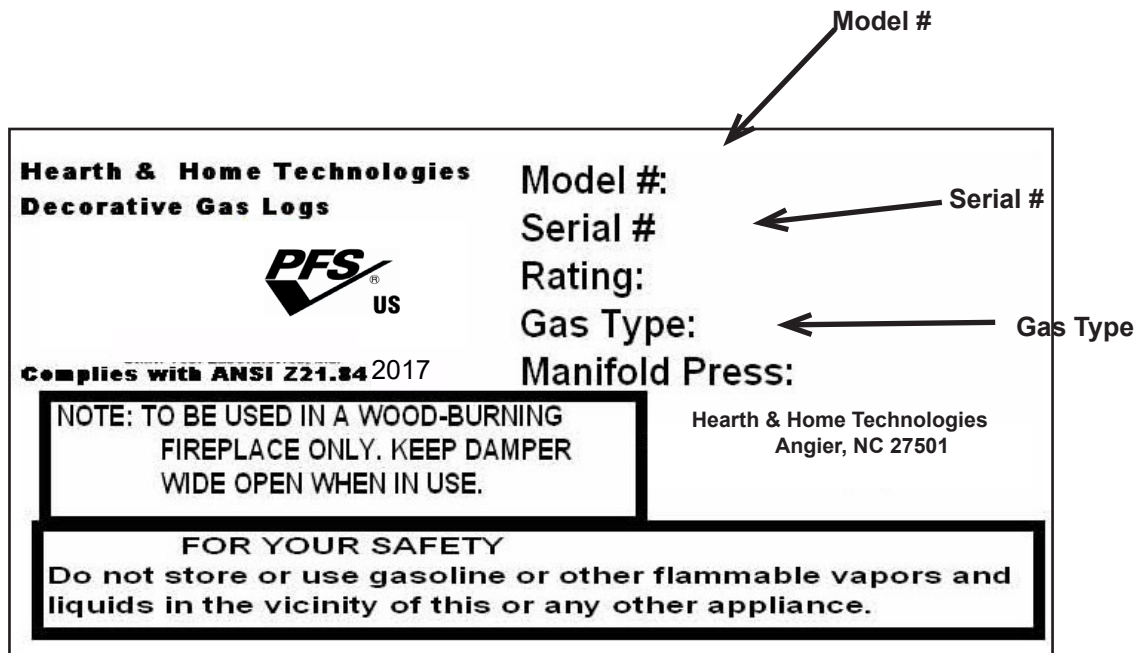



## California Proposition 65 Warning

**Warning:** This product can expose you to chemicals, including carbon black, which is known in the state of California to cause cancer and chromium, which is known in the state of California to cause birth defects or other reproductive harm. For more information go to: [www.P65Warnings.ca.gov](http://www.P65Warnings.ca.gov)



### CAUTION

Sharp Edges

- Wear protective gloves and safety glasses during installation.



## A. Design and Installation Considerations

The Gas Log Hearth Kit consists of the following:

- Log Set
- Burner/Pan Assembly
- Grate Assembly
- Rock Wool
- Sand
- Lava Rock
- Damper Stop
- Vermiculite
- Platinum Embers

Model	Pounds
GO24MTCH-HK	53
GO30MTCH-HK	64

## B. Tools and Supplies Needed

Tools and supplies normally required for installation:

- Pliers
- Phillips screwdriver
- Tape measure
- Crescent wrenches
- Gas shutoff valve
- Non-corrosive leak check solution
- 3/4 in. wrench, 7/16 in. wrench

## C. Important!

- Do not remove any of the attached metal plates, which contain important safety and operating information.
- Keep the appliance area clear and free of all combustible materials, gasoline and other flammable vapors and liquids.
- Any safety screen or guard removed during servicing must be replaced before operation.
- **A qualified service technician must perform installation and repair.** The appliance should be inspected and cleaned annually by a qualified service technician. More frequent cleaning may be required due to excessive lint, dust, pet hair, etc. It is imperative that the control compartments, burners and air passageways are unobstructed during operation.



### WARNING



**HOT! DO NOT TOUCH.  
SEVERE BURNS MAY RESULT.  
CLOTHING IGNITION MAY RESULT.**



Glass and other surfaces are hot during operation and cool down.

- Keep children away.
- CAREFULLY SUPERVISE children in same room as appliance.
- Alert children and adults to hazards of high temperatures.
- Keep clothing, furniture, draperies and other combustibles away.
  - Review proper placement of logs, rockwool, lava rock and vermiculite.
  - Check the wiring.
  - Ensure there are no gas leaks.
  - Ensure the flow of combustion and ventilation air is not obstructed (front grilles and vent caps).
- Before installing into a solid fuel burning fireplace, the chimney and firebox should be inspected and cleaned to remove soot, creosote, ashes, paint, bird nests etc.
- Annual examination of the chimney must be performed by a qualified agency to ensure proper ventilation of flue gases created by this appliance.
- Have the chimney and adjacent structure inspected and cleaned by qualified professionals. Hearth & Home Technologies recommends that NFI or CSIA certified professionals, or technicians under the direction of certified professionals, conduct a minimum of an **NFPA 211 Level 2** inspection of the chimney.
- Replace component parts of the chimney and fireplace as specified by the professionals.
- Ensure all joints are properly engaged and the chimney is properly secured.
- Do not allow fans to blow directly into the fireplace. Avoid any drafts that alter burner flame pattern.
- Do not use a blower insert, heat exchanger insert or other accessories not approved for use with this appliance.



### WARNING

Improper installation, adjustment, alteration, service or maintenance can cause injury or property damage. Refer to the owner's information manual provided with this appliance. For assistance or additional information consult a qualified installer, service agency or the gas supplier.

- This appliance must have a screen in place while the appliance is in operation and, unless other provisions for combustion air are provided, the screen shall have an opening for introduction of combustion air.
- Solid fuels shall not be burned in a fireplace where a decorative appliance is installed.
- If glass doors are present, the **glass doors must be fully opened** while appliance is in operation.

**⚠ WARNING**

Do NOT use this appliance if any part has been under water. Immediately call a qualified service technician to inspect the appliance and to replace any part of the control system and any gas control which has been under water.

### D. Appliance Certification

This appliance has been evaluated by PFS in accordance with the requirements of Ansi Z21.84-2017 *Standard for Decorative Log Sets for Installation in Wood Burning Fireplaces*. Installation and the provisions for combustion and ventilation air must conform to the **National Fuel Gas Code, ANSI Z223.1/NFPA 54**, or the **CSA B149.1, Natural Gas and Propane Installation Code**.

### E. Gas Supply Connection

A 3/8 in. flared fitting has been installed on the gas valve inlet at the factory. Ensure fittings are of the appropriate size and type on the gas line connection. If the tubing has to be cut to length be sure to use the proper cutting and flaring tool. Also, be careful not to crimp the tubing while bending. If the tubing becomes crimped, do not use for installation.

Gas resistant pipe compound must be used on all threaded male connections to ensure a tight seal.

### F. Gas Pressure

Proper input pressures are required for optimum appliance performance. Gas line sizing requirements need to be made following **NFPA51**.

**⚠ WARNING**



**Fire Risk  
Explosion Risk**

- High pressure will damage valve.
- Disconnect gas supply piping **BEFORE** pressure testing gas line at test pressures above 1/2 psig.
  - Close the manual shutoff valve **BEFORE** pressure testing gas line at test pressures equal to or less than 1/2 psig.

**⚠ WARNING**

**Fire Risk  
Explosion Risk**

Verify inlet pressures.

- High pressure may cause overfire condition.
- Low pressure may cause explosion.

Install regulator upstream of valve if line pressure is greater than 1/2 psig.



- Gas Supply Pressure: Minimum inlet gas supply pressure must be 7.0 in. W.C. for natural gas. The gas line supplying the appliance must be sufficient size to furnish the appropriate supply pressure to the appliance while operating in the “High” setting.
- Pressure tap screws must be closed before turning gas on to the appliance.
- Gas Line Pressure Test: Perform pressure test according to state and local code (if pressure exceeds 1/2 in. psi (3.5 kPa)) before appliance is connected. Be sure to release air pressure from the gas line before connection is made to the appliance. Excessive pressure will damage the gas control and may cause a gas leak.
- Gas Leak Test: Make sure the gas connections are tight. Turn on the gas and coat each joint with a non-corrosive gas leak check solution. Air bubbles will form indicating any leaks. DO NOT USE A FLAME OR ANY TYPE OF IGNITION SOURCE TO CHECK FOR LEAKS. All leaks must be corrected before proceeding with installation.
- The appliance must only be installed in a solid-fuel burning fireplace with the flue damper clamped open according to Tables 1 and 2. The fireplace must be constructed of non-combustible material.
- The minimum permanent free opening (in square inches) that must be provided by the fireplace chimney or damper to vent the flue gases is provided in Tables 1 and 2. If the free opening is smaller than the specified area, do not use this appliance.
- The damper must be removed or fixed in a manner in which will secure it open. Some jurisdictions require the damper to be removed or permanently welded fully open. Check with state and local codes.
- Be sure that the chimney is completely unobstructed to ensure proper ventilation of flue gases including carbon monoxide (CO). CO (a poisonous gas) is tasteless, odorless, colorless and undetectable without proper equipment.
- Refer to Table 3 to determine minimum fireplace opening requirements before proceeding.

## G. Negative Pressure

Negative pressure results from the imbalance of air available for the fireplace to operate properly. Causes for this imbalance include:

- Exhaust fans (kitchen, bath, etc.).
- Range hoods.
- Combustion air requirements for furnaces, water heaters and other combustion appliances.
- Clothes dryers.
- Location of return-air vents to furnace or air conditioning.
- Imbalances of the HVAC air handling system.
- Upper level air leaks: recessed lighting, attic hatch opening, duct leaks.

Table 1 for Factory Built Fireplaces		
Free Opening Area (in square inches) of Chimney Damper for Venting combustion Products from Decorative Appliances for Installation in Solid Fuel Burning Fireplaces.		
Chimney Ht. (Feet)*	GO24	GO30
10	Not approved	not approved
15	38.5	45.4
20	31.2	37.4
25	27.3	31.2
30	24.6	28.3
35	22.1	25.5
40	20.4	23.8
Table 2 for Masonry Built Fireplaces		
Free Opening Area (in square inches) of Chimney Damper for Venting combustion Products from Decorative Appliances for Installation in Solid Fuel Burning Fireplaces.		
Chimney Ht. (Feet)*	GO24	GO30
6	64	71.4
8	59.7	66.9
10	54.3	60.2
15	48.8	54.1
20	44.4	49.1
30	40.3	44.5
* Height is measured from the hearth to the top of the chimney. Minimum height is 6 ft.		

 <b>WARNING</b>	
	<b>Asphyxiation Risk</b>
	<p>This appliance produces carbon monoxide (CO).</p> <ul style="list-style-type: none"> <li>• The free opening areas (in square inches) of the chimney damper as shown in the following tables must be met.</li> <li>• User must make sure damper is locked open.</li> <li>• The installer is responsible to ensure proper ventilation of flue gases before appliance is used.</li> </ul> <p>Fire needs to draft properly for safe operation.</p>

**Table 3 for Minimum Fireplace Dimensions**

Log Set	Front Opening	Depth	Height	Rear Width	Natural BTU
GO24MTCH-HK	32"	20"	18"	21"	73,000
GO30MTCH-HK	38"	20"	18"	27"	80,000

## H. Inspect the Appliance and Components

- Remove the contents from the carton labeled “Burner”. Attached to the burner are tags identifying the manufacturer name, serial number, model number (including gas log size), BTU ratings, gas type, etc.
- Review the attached tags before proceeding. Ensure that all minimum fireplace dimension requirements are achieved using [Table 3](#). See Figure 1. Ensure the gas type provided in the fireplace coincide with the gas type marked on the tag.

Figure 1 Measure Firebox



- The burner is assembled with the controls installed at the factory and is designed to connect one end of the 3/8 in. supply line before placing inside the fireplace. Ensure the connection is tightened using a 3/4 in. wrench.
- Place the burner towards the rear and center of the fireplace and connect to the gas line. Follow instructions in “F. Gas Pressure” to check for gas leaks.

## I. For Natural Gas Installation

- Pour sand into the burner pans to the point where the burner pipe is covered. See Figure 2. Level the sand from right to left to ensure an even flame pattern. At this point the pan should be half full.

Figure 2 Sand



Figure 3 Placing Vermiculite



.Pour vermiculite over the sand in the pans until they are full. See Figure 3.

**Note:** For best results, do not pack down the rock wool. The placement of rock wool can have an effect on flame pattern and may need to be adjusted to achieve a desired appearance.

Figure 4 Placing Rock Wool

Figure 4-carry over tube

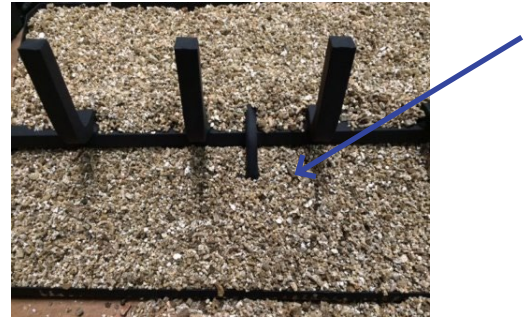





Thightly pack dime sized pieces of rock wool around the vertical part of the carry over tube to aid in lighting the bottom burner pan. See Figure 4a. Cover the rest of the exposed tube with additional rock wool pieces. See Figure 4a and 4c.

Figure 4a-Packing rock wool around the carry over tube



Figure 4b-Carry over tube covered by rock wool



	
	
<p><b>Fire Risk</b>  <b>Explosion Risk</b>  <b>Personal Injury Risk</b></p>	
<p>Failure to position the parts in accordance with the diagrams provided with the log packages or failure to use only parts approved with this appliance may result in</p>	
	

- Once carry over tube is covered, lightly place dime-size pieces of rock wool evenly on top of the vermiculite to achieve a glowing ember effect. See Figure 4c.

Figure 4c-Placing remaining rock wool



- Remove the Platinum Bright Embers™ from the package. For optimum performance peel each piece apart in layers and lightly place on top of the vermiculite and rock wool where the flame is blue. This will achieve the desired realism.
- The gas burns at the point of the least resistance. In case of an uneven flame pattern it may be necessary to adjust the materials in the pans (using an object such as a screwdriver) to achieve the desired effect.
- Place desired amount of lava granules on the floor of the fireplace. **DO NOT ALLOW THE GRANULES TO COME IN CONTACT WITH THE FLAMES.** (Lava granules may contain moisture which, when heating, may cause it to pop out during installation and set-up.) Ensure the controls and switches are unobstructed after the granules are installed.
- Place logs. See Sections L & N.
- Place accent logs around burner on floor of fireplace.

Figure 5-Adjusting flame pattern

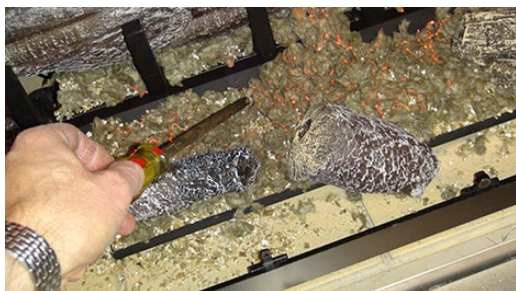

## J. Damper Stop Installation Instructions

Included in the burner assembly box is a damper stop clamp which attaches to the damper as shown (Figure 6). Install the clamp to the damper ensuring that the minimum requirements (Tables 1 and 2) are achieved. Use a 7/16 in. wrench to secure the clamp to the damper. If the damper clamp provided does not fit your application, other means of securing the proper opening must be provided by the installer.

Figure 6 Damper Stop Clamp

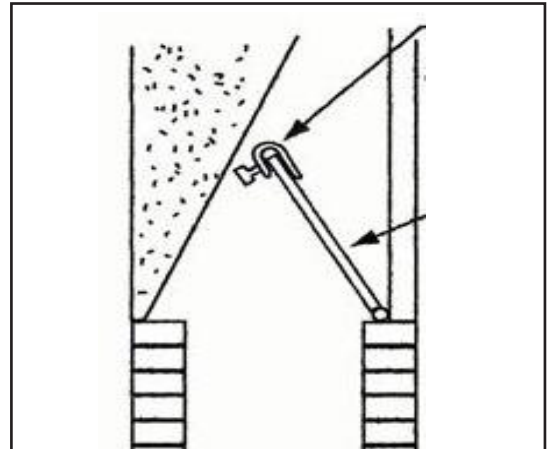

**Note:** The state of Massachusetts requires that the chimney flue damper, when used with gas logs, be welded open or completely removed. In the Commonwealth of Massachusetts this appliance must be installed by a licensed plumber or gasfitter.

## K. Inspect the Venting System

The fireplace venting system is designed and constructed to develop a positive flow adequate to remove flue gases to the outside atmosphere. See fireplace installation instructions.

### A spillage test must be made before the installed appliance is left with the consumer.

- Close all doors and windows in the home.
- Light the log set (see Lighting Instructions).
- After three minutes, test with a smoke match, smoke candle, stick incense or cigarette 1 in. below the top of the opening (lintel) moving across the full width. If spillage (smoke down into the room) occurs, it will most likely be near the top, outside corners.

### Possible cures if spillage occurs:

- The damper needs to be opened further.
- The fireplace opening needs to be reduced by adding a drop panel across the top under the lintel.
- The air supply from outdoors needs to be increased. Open the outside air kit if the appliance is so equipped, or crack open a door or window.
- If necessary, seek expert advice. Do not operate this appliance.

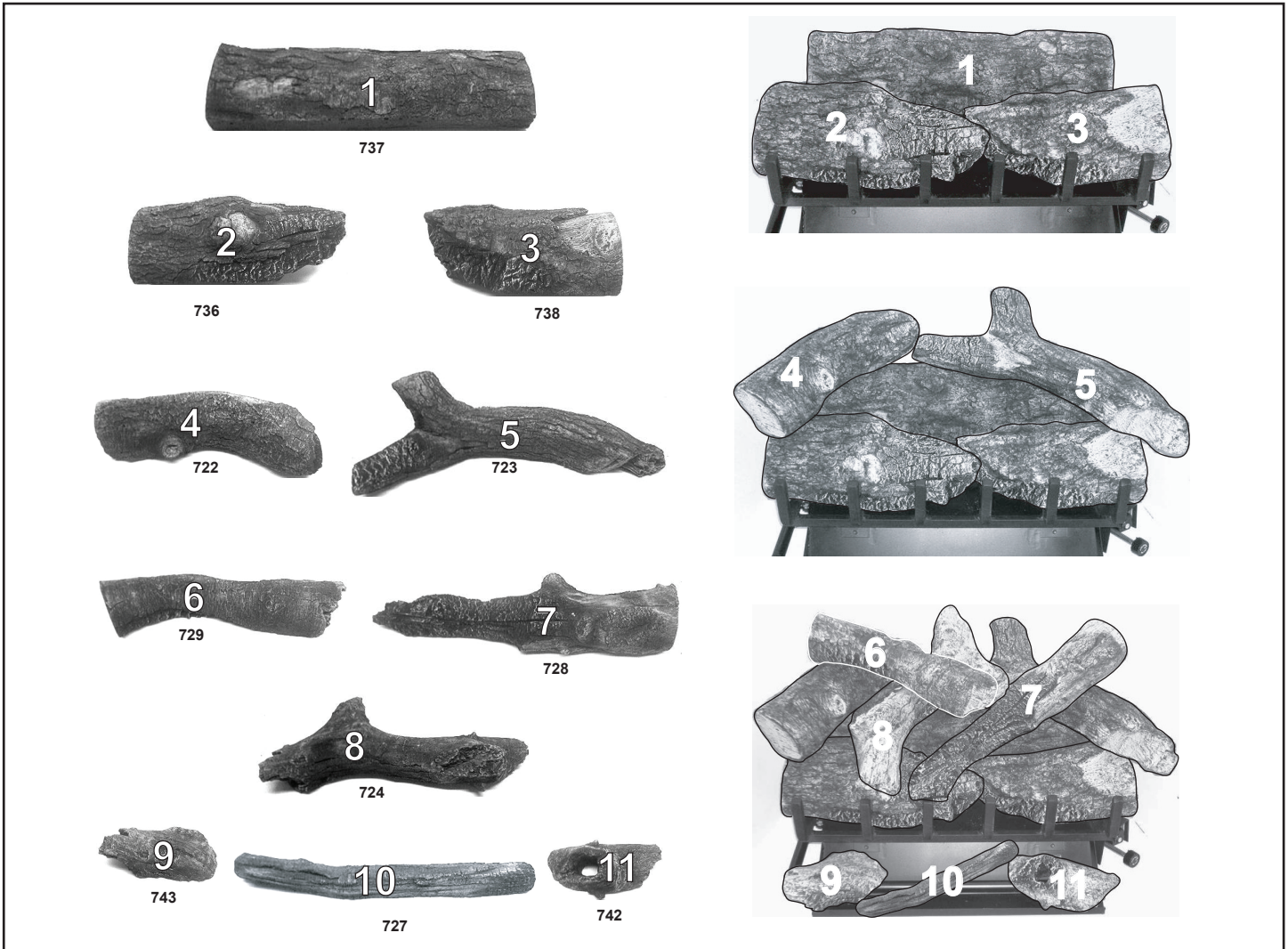

IMPORTANT: THIS IS DATED INFORMATION. Parts must be ordered from a dealer or distributor. **Hearth and Home Technologies does not sell directly to consumers.** Provide model number and serial number when requesting service parts from your dealer or distributor.



**Stocked at Depot**

ITEM	DESCRIPTION	COMMENTS	PART NUMBER
	Log Set Assembly		GO24
1	Log # 1		SRV737
2	Log # 2		SRV736
3	Log # 3		SRV738
4	Log # 4		SRV722
5	Log # 5		SRV723
6	Log # 6		SRV729
7	Log # 7		SRV728
8	Log # 8		SRV724
9	Log # 9		SRV743
10	Log # 10		SRV727
11	Log # 11		SRV742



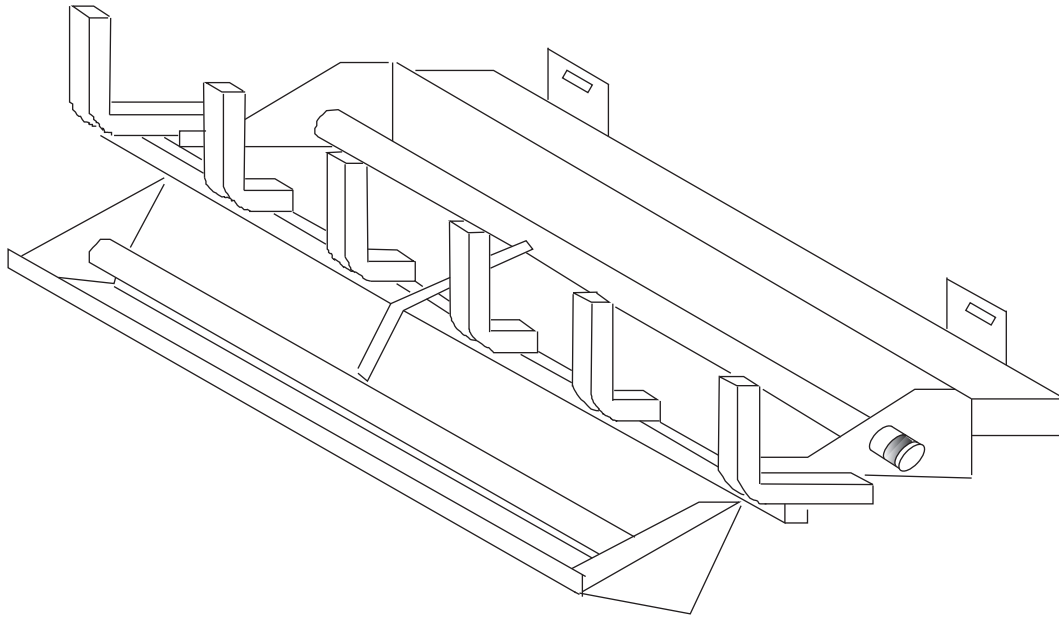

IMPORTANT: THIS IS DATED INFORMATION. Parts must be ordered from a dealer or distributor. **Hearth and Home Technologies does not sell directly to consumers.** Provide model number and serial number when requesting service parts from your dealer or distributor.



**Stocked at Depot**

ITEM	DESCRIPTION	COMMENTS	PART NUMBER
1	Connector		FT-1-24
	Sand		SRVACC15
	Lava Rock	Qty 2 req	SRVACC10
	Mineral Wool		SRVACC12
	Damper Stop Assembly		SRV500-SC
	Platinum Bright Embers		PBE-5
	Vermiculite		SRVACC11
	Installation Instructions		4004-322

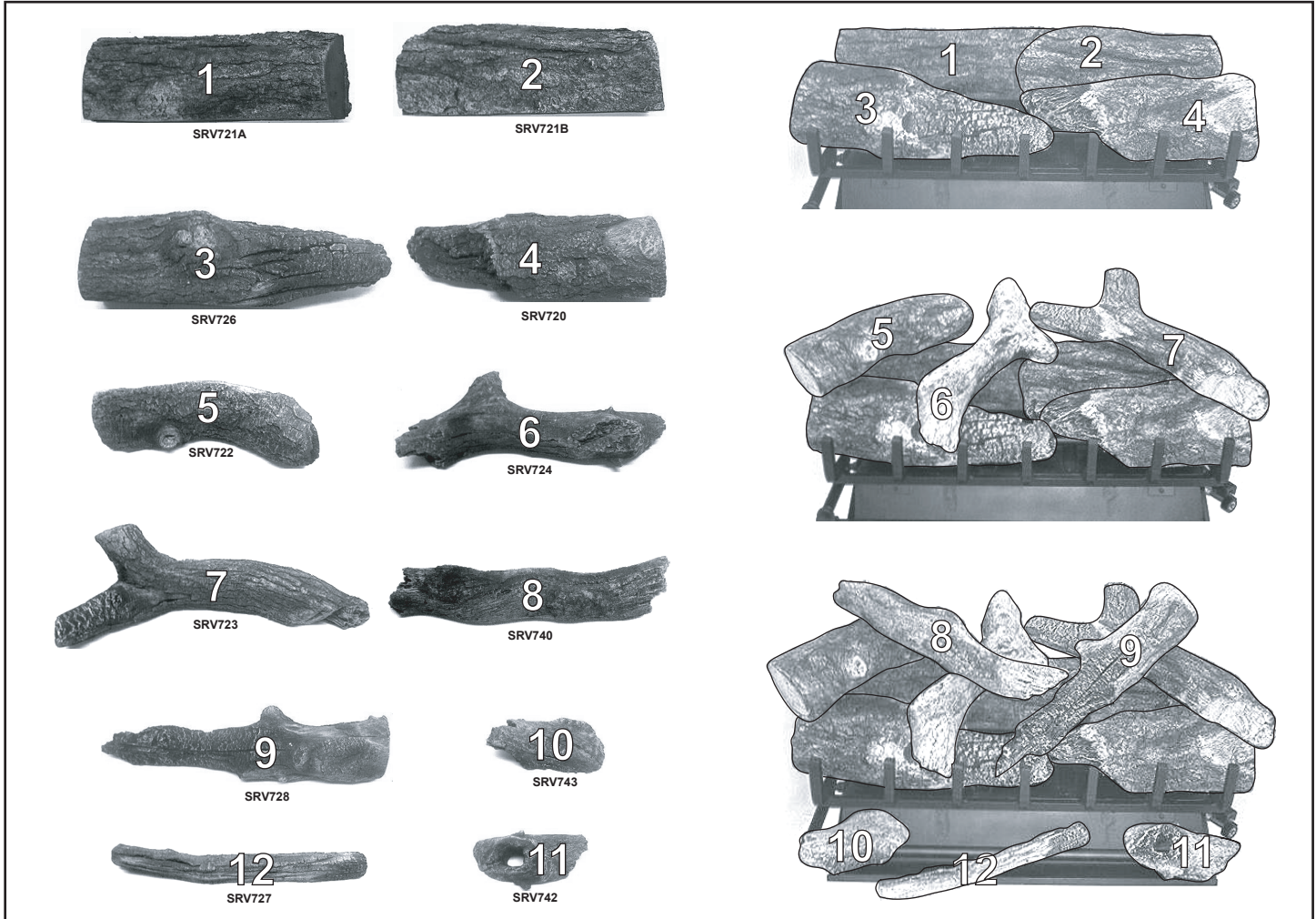

**IMPORTANT: THIS IS DATED INFORMATION.** Parts must be ordered from a dealer or distributor. **Hearth and Home Technologies does not sell directly to consumers.** Provide model number and serial number when requesting service parts from your dealer or distributor.



**Stocked  
at Depot**

ITEM	DESCRIPTION	COMMENTS	PART NUMBER	
	Log Set Assembly		GO30	
1	Log # 1		SRV721A	
2	Log # 2		SRV721B	
3	Log # 3		SRV726	
4	Log # 4		SRV720	
5	Log # 5		SRV722	
6	Log # 6		SRV724	
7	Log # 7		SRV723	
8	Log # 8		SRV740	
9	Log # 9		SRV728	
10	Log # 10		SRV743	
11	Log # 11		SRV742	
12	Log # 12		SRV727	

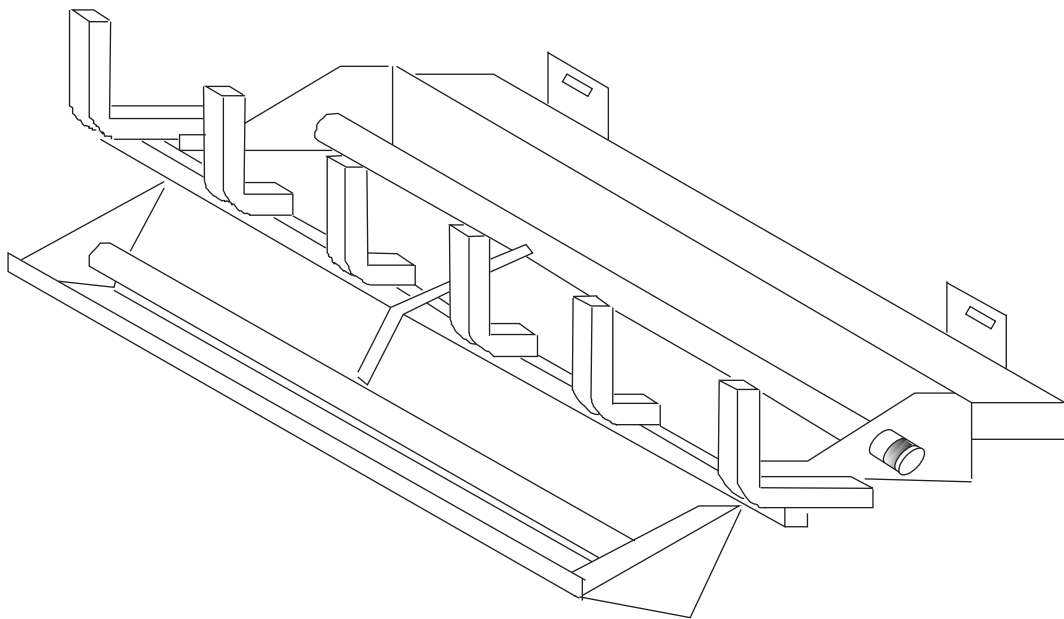

IMPORTANT: THIS IS DATED INFORMATION. Parts must be ordered from a dealer or distributor. **Hearth and Home Technologies does not sell directly to consumers.** Provide model number and serial number when requesting service parts from your dealer or distributor.



**Stocked at Depot**

ITEM	DESCRIPTION	COMMENTS	PART NUMBER
1	Connector		FT-1-30
	Lava Rock	Qty 3 req	SRVACC10
	Mineral Wool	Qty 2 req	SRVACC12
	Sand		SRVACC15
	Damper Stop Assembly		SRV500-SC
	Platinum Bright Embers	Qty 2 req	PBE-5
	Vermiculite		SRVACC11
	Installation Instructions		4004-322

## P. Lighting Instructions- Match Light

<b>⚠ WARNING</b>	
	<b>Asphyxiation Risk</b> Gas-burning appliances produce smoke and carbon monoxide gas during operation. <ul style="list-style-type: none"><li>• The damper <b>must</b> be open</li><li>• The chimney must draw properly</li></ul> These fumes can be harmful if not vented properly.

### FOR YOUR SAFETY READ BEFORE LIGHTING

**WARNING!** IF THESE INSTRUCTIONS ARE NOT FOLLOWED EXACTLY, A FIRE OR EXPLOSION MAY RESULT CAUSING PROPERTY DAMAGE, PERSONAL INJURY OR LOSS OF LIFE.

- This appliance has a manually lighted burner and must be lit by hand. When lighting the burner, follow these instructions exactly.
- BEFORE LIGHTING** smell all around the appliance area for gas. Be sure to smell next to the floor because some gas is heavier than air and will settle on the floor.  
**WHAT TO DO IF YOU SMELL GAS**
  - Do not try to light any appliance.
  - Do not touch any electrical switch; do not use any phone in your building.
  - Immediately call your gas supplier from a neighbor's phone. Follow the gas supplier's instructions.
  - If you cannot reach your gas supplier, call the fire department.
- Do not use this appliance if any part has been under water. Immediately call a qualified service technician to inspect the appliance and to replace any part of the control system and any gas control that has been under water.
- Use only your hand to push in or turn the gas control handle. Never use tools. If the handle will not push in or turn by hand, do not try to repair it. Call a qualified service technician. Force or attempted repair may result in fire or explosion.

### LIGHTING INSTRUCTIONS

- STOP!** Read the safety information previously listed above.
- Turn gas control manual valve to the full "OFF" position.
- Wait 5 minutes to clear out any gas. Then smell for gas, including near the floor. If you smell gas, STOP! Follow "B" in the safety information above on this label. If you don't smell gas, go to the next step.
- Place a lit match on the surface of the burning embers. Do not hold match in hand.
- Turn gas control manual valve to the full "ON" position.
- If appliance will not operate, follow the instructions "TO TURN OFF GAS TO APPLIANCE" and call your service technician or gas supplier.

### TO TURN OFF GAS TO APPLIANCE

Turn manual gas control handle to "OFF" position. Do not force.

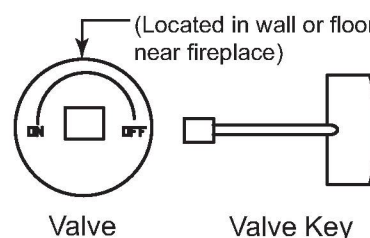

## Q. Cleaning and Maintenance Instructions

Always remember:

- Do not place any combustible material near the appliance.
- Do not place any paper, trash or other material on the log set or in the heater.
- Do not touch any part of the appliance when it is in operation.
- Do not operate this appliance without the fireplace screen closed.

### CAUTION

Before cleaning the appliance, be sure it is turned completely off. The appliance must be completely cooled.

### CAUTION

- Logs can get very hot. Handle only when they are cool.

### CAUTION

After burning, the logs become fragile. Take care in handling.

## Cleaning

- Periodic examination and cleaning of the venting system of the fireplace should be done before initial use and at least annually by a qualified agency.

Your appliance is designed to be virtually maintenance free, although periodic visual inspection and cleaning is required. Follow the instructions below for the correct procedures. An annual examination and cleaning the venting system by a qualified person is also recommended.

If at any time the flames on your log set look abnormal or an odor is noticed coming from the appliance, contact a qualified service technician or the gas company.

Inspect the main burner.

### Do not allow soot to build up on the logs

Your logs require little care. Keep the burner assembly, logs and burner area surrounding the logs clean by brushing with a dry paint brush at least twice a year.

## R. Frequently Asked Questions

<b>Can I close the glass doors on my fireplace when using my gas logs?</b>
<b>No. The gas log sets are designed for use in fireplaces with all fireplace doors fully opened. Operating your log set with the doors closed will cause overheating, premature failure of valve systems, and will void the warranty of your log set.</b>
<b>What sort of maintenance do gas logs require?</b>
<b>Vented gas logs do not require regular maintenance. However, it is a good idea to have valves, pilots and gas connections on your set periodically inspected by a hearth professional. Although it is not required maintenance, annually refurbishing the ember material and periodic cleaning of the logs will help maintain your set's beauty and realism.</b>
<b>Does the ember material burn-up, and do I need to replace it periodically?</b>
<b>The ember material is a fireproof, organic mineral material called rock wool, and does not burn or require periodic replacement; however, annual refurbishment of the embers will help maintain the beauty and realism of your log set.</b>
<b>Can I burn real wood along with my gas logs?</b>
<b>No. The intense heat of a wood fire will damage your logs, burners, grates and valves, and will void your warranty.</b>
<b>Will gas logs help my chimney that drafts poorly?</b>
<b>No. Improper or poor draft will not be helped by gas logs. Please have your chimney inspected by a hearth professional or chimney sweep in order to determine how to correct the problem.</b>
<b>Can I close my fireplace damper to get more heat from my vented gas log set?</b>
<b>No. Vented gas logs are designed to be operated with the damper in the fully opened position. This gas log set produces carbon monoxide gas. The damper must be removed or clamped fully open using the "C" clamp provided with the set.</b>
<b>My gas logs make a whistling noise when I burn them. What causes this?</b>
<b>This behavior is normally caused by using a corrugated flex connector to hook up the gas log set. We recommend the installer use the supplied aluminum connector rather than the corrugated flexible type.</b>
<b>Can I move or change the position of the logs on my gas log set?</b>
<b>CSA certified log sets should not be altered - log placement must be exactly as indicated in the set's installation instructions. Log placement on non-certified, vented log sets may be altered, but minimal handling is recommended, to prevent log breakage.</b>
<b>Can I install my gas log set myself?</b>
<b>No. We recommend installation be performed by an NFI certified hearth professional, HVAC professional, gas fitter, or plumber experienced in gas log installation. Most localities require installation of any gas appliance to be performed by a professional. Please check with your local inspection agency/department.</b>
<b>What are the gas logs made of?</b>
<b>The gas logs are made of a mixture of pre-fired, expanded clay and a special high-temperature cement, with a wire mesh reinforcement. This combination creates a strong, ceramic material capable of withstanding extreme temperatures, yet also allows molding of the intricate detail found in these gas log sets.</b>
<b>I have a vented log set, and the logs have black soot on them. Is this normal?</b>
<b>Soot build-up on vented gas logs is a normal part of the combustion process. Natural gas log sets generally produce less soot than liquid propane log sets. We recommend any soot build up be removed periodically using a product designed for gas log soot removal.</b>
<b>Can I add a remote control to my log set after it has been installed?</b>
<b>No.</b>
<b>Is the gas log set approved by a testing agency?</b>
<b>Yes. The GO series has been design certified by PFS under the ANSI Z21.84-2017</b>
<b>What is the warranty coverage of the GO log set?</b>
<b>The logs carry a lifetime warranty to the original owner in the original installation. All metal parts (burners, brackets, grates, etc.) carry a 5-year warranty and all valves, pilot assemblies, and other mechanical parts are warranted for 1 year. The complete warranty is printed in the back of the owner's manual.</b>

**Hearth & Home Technologies LLC**  
**LIMITED WARRANTY**

Hearth & Home Technologies LLC (“HHT”) extends the following warranty for HHT gas, wood, pellet and electric hearth appliances (each a “Product” and collectively, the “Product(s)”) and certain component parts set forth in the table below (“Component Part(s)”) that are purchased from a HHT authorized dealer or distributor.

**WARRANTY COVERAGE:**

HHT warrants that the Products and their Component Parts will be free from defects in materials and workmanship for the applicable period of Warranty coverage set forth in the table below (“Warranty Period”). If a Product or Component Parts are found to be defective in materials or workmanship during the applicable Warranty Period, HHT will, at our discretion, repair the applicable Component Part(s), replace the applicable Component Part(s), or refund the purchase price of the applicable Product(s). The maximum amount recoverable under this Warranty is limited to the purchase price of the Product. This Warranty is transferable from the original purchaser to subsequent owners, but the Warranty Period will not be extended in duration or expanded in coverage for any such transfer. This Warranty is subject to conditions, exclusions, and limitations as described below.

**WARRANTY PERIOD:**

Warranty coverage begins at the date of installation. In the case of new home constructions, Warranty coverage begins six months after invoice of the final sale of the Product(s) by an independent, authorized HHT dealer or distributor. However, the Warranty coverage shall commence no later than 24 months following the date of Product shipment from HHT, regardless of the installation or purchase date.

Warranty Period		HHT Manufactured Appliances and Venting				
Component Parts	Labor	Gas	Pellet	Wood	Electric	Component Parts Covered by this Warranty
1 Year		X	X			All parts including handles, external enameled components and other material except as covered by Warranty Conditions, Warranty Exclusions, and Warranty Limitations listed
2 Years					X	All parts except as covered by Warranty Conditions, Warranty Exclusions, and Warranty Limitations listed
			X	X		Glass, Electrical components limited to heating element/igniters, Top feed auger assembly, Blowers, Junction Box, Remotes/Wall switches, linear actuator, power cord, vacuum switch, snap disc, wire harnesses and thermocouple
		X				Electrical components limited to modules, remotes/wall switches, valves, pilots, blowers, junction boxes, wire harnesses, transformers and lights (excluding light bulbs)
		X		X		Cement Refractory Panels, Glass Liner Panels
3 years			X			Firepots, burnpots, Harman mechanical feeders
5 years		X		X		Catalysts, Vented and Vent Free burners and logs
10 years	1 year	X				Burners, logs and metal/fiber refractory components of HHT manufactured fireplaces or stoves, venting due to poor workmanship
10 years	3 years		X	X		Castings, Medallions & Baffles, FlexBurn® System (engine, inner cover, access cover and fireback), Firebox and heat exchanger, HHT Chimney & Terminations, Manifolds
20 years	3 years	X				Firebox and heat exchanger
<b>All purchased replacement parts and optional accessories</b>						
1 Year	None	X	X			All purchased replacement parts and optional accessories

## **WARRANTY CONDITIONS:**

- Because HHT cannot control the quality of any Products sold by unauthorized sellers, this Warranty only covers Products that are purchased through an HHT authorized dealer or distributor unless otherwise prohibited by law; a list of HHT authorized dealers is available on the HHT branded websites.
- This Warranty is only valid while the applicable Product remains at the site of original installation.
- This Warranty is only valid in the country in which the HHT authorized dealer or distributor that sold the applicable Product is authorized to sell applicable Product.
- Contact your installing distributor or dealer for Warranty service. If the installing dealer or distributor is unable to provide necessary parts, contact the nearest HHT authorized dealer or supplier. Additional service fees may apply if you are seeking Warranty service from a dealer other than the dealer from whom you originally purchased the applicable Product.
- No HHT consumer should bear cost of warranty service or costs incurred while servicing warranty claims (i.e., travel, gas, or mileage) when the service is performed within the terms of this Warranty. Check with your dealer or distributor in advance for any costs to you when arranging a warranty call. Travel and shipping charges for parts are not covered by this Warranty.

## **WARRANTY EXCLUSIONS:**

This Warranty does not cover the following:

- Changes in surface finishes as a result of normal use. As a heating appliance, some changes in color of interior and exterior surface finishes may occur. This is not a flaw and is not covered under the Warranty.
- Damage to printed, plated, or enameled surfaces caused by fingerprints, accidents, misuse, scratches, melted items or other external sources and residues left on the plated surfaces from the use of abrasive cleaners or polishes.
- Repair or replacement of parts that are subject to normal wear and tear during the Warranty Period are not covered. These parts include: paint, wood and pellet gaskets, firebricks, wood grates, flame guides, batteries and the discoloration of glass.
- Minor expansion, contraction, or movement of certain parts causing noise. These conditions are normal and complaints related to this noise are not covered by this Warranty.
- Damages resulting from: (1) failure to install, operate, or maintain the applicable Product in accordance with the installation instructions, operating instructions, and listing agent identification label furnished with the applicable Product; (2) failure to install the applicable Product in accordance with local building codes; (3) shipping or improper handling; (4) improper operation, abuse, misuse, continued operation with damaged, corroded or failed components, accident, or improperly/incorrectly performed repairs; (5) environmental conditions, inadequate ventilation, negative pressure, or drafting caused by tightly sealed constructions, insufficient make-up air supply, or handling devices such as exhaust fans or forced air furnaces or other such causes; (6) use of fuels other than those specified in the operation instructions; (7) installation or use of components not supplied with the applicable Product or any other components not expressly authorized and approved by HHT; (8) modification of the appliance not expressly authorized and approved by HHT in writing; and/or (9) interruptions or fluctuations of electrical power supply to the applicable Product.
- Non-HHT venting components, hearth connections or other accessories used in conjunction with the applicable Product.
- Any part of a pre-existing fireplace system in which an insert or a decorative gas applicable Product is installed.
- HHT's obligation under this Warranty does not extend to the Product's capability to heat the desired space. Information is provided to assist the consumer and the dealer in selecting the proper Product for the application. Consideration must be given to the Product location and configuration, environmental conditions, insulation and air tightness of the structure.

**This warranty is void if:**

- The applicable Product has been over-fired, operated in atmospheres contaminated by chlorine, fluorine, or other damaging chemicals. Over-firing can be identified by, but not limited to, warped plates or tubes, deformation/warping of interior cast iron structure or components, rust colored cast iron, bubbling, cracking and discoloration of steel or enamel finishes.
- The applicable Product is subjected to prolonged periods of dampness or condensation.
- There is any damage to the applicable Product due to water or weather damage which is the result of, but not limited to, improper chimney or venting installation.

## **LIMITATIONS OF REMEDIES AND LIABILITY:**

- **EXCEPT TO THE EXTENT PROVIDED BY LAW, HHT MAKES NO EXPRESS WARRANTIES OTHER THAN THE WARRANTY SPECIFIED HEREIN. The owner's exclusive remedy and HHT's sole obligation under this Warranty or in contract, tort or otherwise, shall be limited to, at HHT's sole option, replacement of the Component Part(s), repair of the Component Part(s), or refund of the original purchase price of the applicable Product(s). In no event will HHT be liable for any incidental or consequential damages caused by defects in the applicable Product. Some States do not allow the exclusion or limitation of incidental or consequential damages, so the above limitation or exclusion may not apply to you. This Warranty gives you specific legal rights and you may also have other rights which vary from State to State. THE DURATION OF ANY IMPLIED WARRANTY IS LIMITED TO DURATION OF THE EXPRESSED WARRANTY SPECIFIED ABOVE FOR THE APPLICABLE PRODUCT. Some States do not allow limitations on how long an implied warranty lasts, so the above limitation may not apply to you.**



## S. Contact Information



**Please contact your Hearth & Home Technologies dealer with any questions or concerns.**  
For the number of your nearest Hearth & Home Technologies dealer, please call 1-800-927-6841 or 1-888-427-3973.

### - NOTES -

---

---

---

---

---

---

---

---

---

---

### CAUTION



#### DO NOT DISCARD THIS MANUAL

- Important operating and maintenance instructions included.
- Read, understand and follow these instructions for safe installation and operation.
- Leave this manual with party responsible for use and operation.

