

This appliance has been retired.
Service parts pages within have been removed.
For replacement parts, please refer to the individual
service parts list located on the brand websites.

Owner's Manual

Care and Operation

INSTALLER: Leave this manual with party responsible for use and operation.

OWNER: Retain this manual for future reference.

Contact your dealer with questions regarding installation, operation or service.

NOTICE: DO NOT discard this manual!

HEAT & GLO

No one builds a better fire

Models:

MEZZO36

MEZZO36ST

MEZZO48

MEZZO48ST

MEZZO60

MEZZO60ST

MEZZO72

MEZZO72ST

GAS-FIRED

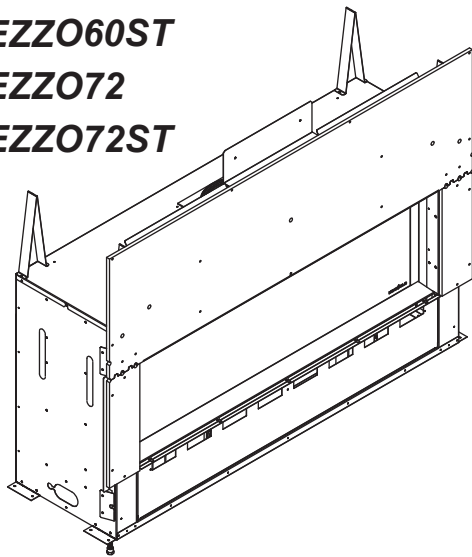

⚠ WARNING:
FIRE OR EXPLOSION HAZARD
Failure to follow safety warnings exactly
could result in serious injury, death, or
property damage.

- **DO NOT** store or use gasoline or other flammable vapors and liquids in the vicinity of this or any other appliance.
- **What to do if you smell gas**
 - **DO NOT** try to light any appliance.
 - **DO NOT** touch any electrical switch. **DO NOT** use any phone in your building.
 - Leave the building immediately.
 - Immediately call your gas supplier from a neighbor's phone. Follow the gas supplier's instructions.
 - If you cannot reach your gas supplier, call the fire department.
- Installation and service must be performed by a qualified installer, service agency, or the gas supplier.

This appliance may be installed as an OEM installation in manufactured home (USA only) or mobile home and must be installed in accordance with the manufacturer's instructions and the *Manufactured Home Construction and Safety Standard, Title 24 CFR, Part 3280* in the United States, or the *Standard for Installation in Mobile Homes, CAN/CSA Z240 MH Series*, in Canada.

This appliance is only for use with the type(s) of gas indicated on the rating plate. This appliance is not convertible for use with other gases, unless a certified kit is used.

! DANGER



**HOT GLASS WILL
CAUSE BURNS.**

**DO NOT TOUCH GLASS
UNTIL COOLED.**

**NEVER ALLOW CHILDREN
TO TOUCH GLASS.**

A barrier designed to reduce the risk of burns from the hot viewing glass is provided with this appliance and shall be installed for the protection of children and other at-risk individuals.

In the Commonwealth of Massachusetts installation must be performed by a licensed plumber or gas fitter.

See appliance installation manual for additional Commonwealth of Massachusetts requirements.

1 Welcome

Read this manual before operating this appliance.
Please retain this Owner's Manual for future reference.

Read the Installation Manual before making any installation or finishing changes.

A. Congratulations

Congratulations on selecting a Heat & Glo gas fireplace, an elegant and clean alternative to wood burning fireplaces. The Heat & Glo gas fireplace you have selected is designed to provide the utmost in safety, reliability, and efficiency.

As the owner of a new fireplace, you'll want to read and carefully follow all of the instructions contained in this owner's manual. Pay special attention to all cautions and warnings.

This owner's manual should be retained for future reference. We suggest that you keep it with your other important documents and product manuals.

The information contained in this owner's manual, unless noted otherwise, applies to all models and gas control systems.

Your new Heat & Glo gas fireplace will give you years of durable use and trouble-free enjoyment. Welcome to the Heat & Glo family of fireplace products!

Local Dealer Information

DEALER: Fill in your name, address, phone and email information here and appliance information below.

Dealer Name: _____
 Address: _____

 Phone: _____
 Email: _____

Appliance Information:

Brand: _____ Model Name: _____
 Serial Number: _____ Date Installed: _____

Listing Label Information/Location

The model information regarding your specific fireplace can be found on the rating plate usually located in the control area of the fireplace.

HEAT & GLO Heat & Glo, a brand of Hearth & Home Technologies
 No one builds a better fire 7571 215th Street West, Lakeville, MN 55044

GAS-FIRED
UL US LISTED

Not for use with solid fuel.
 (Ne doit pas être utilisé avec un combustible solide).

Type of Gas (Sorte De Gaz): This appliance must be installed in accordance with local codes, if any; if not, follow ANSI Z223.1 in the USA or CAN/CSA B149 installation codes. (Installer l'appareil selon les codes ou règlements locaux ou, en l'absence de tels règlements, selon les codes d'installation CAN/CSA-B149.)

NATURAL GAS
 ANSI Z21XX-XXXX · CSA 2.XX-MXX

Minimum Permissible Gas Supply for Purposes of Input Adjustment.		
Approved Minimum (De Gaz) Acceptable	0.0 in w.c.	(Po. Col. d'eau)
Maximum Pressure (Pression)	0.0 in w.c.	(Po. Col. d'eau)
Maximum Manifold Pressure (Pression)	0.0 in w.c.	(Po. Col. d'eau)
Minimum Manifold Pressure (Pression)	0.0 in w.c.	(Po. Col. d'eau)

Total Electrical Requirements: 000Vac, 00Hz., less than 00 Amperes **MADE IN USA**

ALTITUDE:	0-0000 FT.	IN CANADA	0000-0000FT.	Model:	XXXXXXXX
MAX. INPUT BTUH:	00,000		00,000	(Modele):	
MIN. INPUT BTUH:	00,000		00,000	Serial	XXXXXXXX
ORIFICE SIZE:	#XXXXX		#XXXXX	(Serie):	

▲ Safety Alert Key:

- **DANGER!** Indicates a hazardous situation which, if not avoided will result in death or serious injury.
- **WARNING!** Indicates a hazardous situation which, if not avoided could result in death or serious injury.
- **CAUTION!** Indicates a hazardous situation which, if not avoided, could result in minor or moderate injury.
- **NOTICE:** Used to address practices not related to personal injury.

Table of Contents

1 Welcome

- A. Congratulations 2
- B. Limited Lifetime Warranty. 4

2 Product Specific Information

- A. Appliance Certification 6
- B. Glass Specifications 6
- C. BTU Specifications. 6

3 Important Safety and Operating Information

- A. Appliance Safety 7
- B. General Operating Parts 8
- C. Fuel Specifications. 8
- D. Wall Surface/TV Guidelines 8
- E. Before Lighting Appliance. 10
- F. Lighting Instructions (IPI) 11
- G. Appliance Break-In. 12
- H. Heat Management 12
- I. Operation During A Power Outage 13
- J. Detailed Component Operating Instructions
 - IntelliFire™ Plus. 14

4 Maintenance and Service

- A. Maintenance: Frequency and Tasks 15
- B. Maintenance Tasks: Homeowner 15
- C. Maintenance Tasks: Qualified Service Technician 17

5 Frequently Asked Questions and Troubleshooting

- A. Frequently Asked Questions 18
- B. Troubleshooting 19

6 Reference Materials

- A. Accessories 21
- B. Service Parts 22
- C. Contact Information 33

→ = Contains updated information.

B. Limited Lifetime Warranty

Hearth & Home Technologies LIMITED LIFETIME WARRANTY

Hearth & Home Technologies, on behalf of its hearth brands (“HHT”), extends the following warranty for HHT gas, wood, pellet, coal and electric hearth appliances that are purchased from an HHT authorized dealer.

WARRANTY COVERAGE:

HHT warrants to the original owner of the HHT appliance at the site of installation, and to any transferee taking ownership of the appliance at the site of installation within two years following the date of original purchase, that the HHT appliance will be free from defects in materials and workmanship at the time of manufacture. After installation, if covered components manufactured by HHT are found to be defective in materials or workmanship during the applicable warranty period, HHT will, at its option, repair or replace the covered components. HHT, at its own discretion, may fully discharge all of its obligations under such warranties by replacing the product itself or refunding the verified purchase price of the product itself. The maximum amount recoverable under this warranty is limited to the purchase price of the product. This warranty is subject to conditions, exclusions and limitations as described below.

WARRANTY PERIOD:

Warranty coverage begins on the date of original purchase. In the case of new home construction, warranty coverage begins on the date of first occupancy of the dwelling or six months after the sale of the product by an independent, authorized HHT dealer/ distributor, whichever occurs earlier. The warranty shall commence no later than 24 months following the date of product shipment from HHT, regardless of the installation or occupancy date. The warranty period for parts and labor for covered components is produced in the following table.

The term “Limited Lifetime” in the table below is defined as: 20 years from the beginning date of warranty coverage for gas appliances, and 10 years from the beginning date of warranty coverage for wood, pellet, and coal appliances. These time periods reflect the minimum expected useful lives of the designated components under normal operating conditions.

Warranty Period		HHT Manufactured Appliances and Venting							Components Covered
Parts	Labor	Gas	Wood	Pellet	EPA Wood	Coal	Electric	Venting	
1 Year		X	X	X	X	X	X	X	All parts and material except as covered by Conditions, Exclusions, and Limitations listed
2 years				X	X	X			Igniters, electronic components, and glass
		X	X	X	X	X			Factory-installed blowers
		X	X						Molded refractory panels Ignition Modules
3 years				X					Firepots and burnpots
5 years	1 year			X	X				Castings and baffles
7 years	3 years		X	X	X				Manifold tubes, HHT chimney and termination
10 years	1 year	X							Burners, logs and refractory
Limited Lifetime	3 years	X	X	X	X	X			Firebox and heat exchanger
90 Days		X	X	X	X	X	X	X	All replacement parts beyond warranty period

See conditions, exclusions, and limitations on next page.

B. Limited Lifetime Warranty (*continued*)

WARRANTY CONDITIONS:

- This warranty only covers HHT appliances that are purchased through an HHT authorized dealer or distributor. A list of HHT authorized dealers is available on the HHT branded websites.
- This warranty is only valid while the HHT appliance remains at the site of original installation.
- This warranty is only valid in the country in which the HHT authorized dealer or distributor that sold the appliance resides.
- Contact your installing dealer for warranty service. If the installing dealer is unable to provide necessary parts, contact the nearest HHT authorized dealer or supplier. Additional service fees may apply if you are seeking warranty service from a dealer other than the dealer from whom you originally purchased the product.
- Check with your dealer in advance for any costs to you when arranging a warranty call. Travel and shipping charges for parts are not covered by this warranty.

WARRANTY EXCLUSIONS:

This warranty does not cover the following:

- Changes in surface finishes as a result of normal use. As a heating appliance, some changes in color of interior and exterior surface finishes may occur. This is not a flaw and is not covered under warranty.
- Damage to printed, plated, or enameled surfaces caused by fingerprints, accidents, misuse, scratches, melted items, or other external sources and residues left on the plated surfaces from the use of abrasive cleaners or polishes.
- Repair or replacement of parts that are subject to normal wear and tear during the warranty period. These parts include: paint, wood, pellet and coal gaskets, firebricks, grates, flame guides, batteries and the discoloration of glass.
- Expansion, contraction, or movement of certain parts causing noise. These conditions are normal and complaints related to this noise are not covered by this warranty.
- Damages resulting from: (1) failure to install, operate, or maintain the appliance in accordance with the installation instructions, operating instructions, and listing agent identification label furnished with the appliance; (2) failure to install the appliance in accordance with local building codes; (3) shipping or improper handling; (4) improper operation, abuse, misuse, continued operation with damaged, corroded or failed components, accident, or improperly/incorrectly performed repairs; (5) environmental conditions, inadequate ventilation, negative pressure, or drafting caused by tightly sealed constructions, insufficient make-up air supply, or handling devices such as exhaust fans or forced air furnaces or other such causes; (6) use of fuels other than those specified in the operating instructions; (7) installation or use of components not supplied with the appliance or any other components not expressly authorized and approved by HHT; (8) modification of the appliance not expressly authorized and approved by HHT in writing; and/or (9) interruptions or fluctuations of electrical power supply to the appliance.
- Non-HHT venting components, hearth components or other accessories used in conjunction with the appliance.
- Any part of a pre-existing fireplace system in which an insert or a decorative gas appliance is installed.
- HHT's obligation under this warranty does not extend to the appliance's capability to heat the desired space. Information is provided to assist the consumer and the dealer in selecting the proper appliance for the application. Consideration must be given to appliance location and configuration, environmental conditions, insulation and air tightness of the structure.

This warranty is void if:

- The appliance has been over-fired or operated in atmospheres contaminated by chlorine, fluorine, or other damaging chemicals. Over-firing can be identified by, but not limited to, warped plates or tubes, rust colored cast iron, bubbling, cracking and discoloration of steel or enamel finishes.
- The appliance is subjected to prolonged periods of dampness or condensation.
- There is any damage to the appliance or other components due to water or weather damage which is the result of, but not limited to, improper chimney or venting installation.

LIMITATIONS OF LIABILITY:

- The owner's exclusive remedy and HHT's sole obligation under this warranty, under any other warranty, express or implied, or in contract, tort or otherwise, shall be limited to replacement, repair, or refund, as specified above. In no event will HHT be liable for any incidental or consequential damages caused by defects in the appliance. Some states do not allow exclusions or limitation of incidental or consequential damages, so these limitations may not apply to you. This warranty gives you specific rights; you may also have other rights, which vary from state to state. EXCEPT TO THE EXTENT PROVIDED BY LAW, HHT MAKES NO EXPRESS WARRANTIES OTHER THAN THE WARRANTY SPECIFIED HEREIN. THE DURATION OF ANY IMPLIED WARRANTY IS LIMITED TO DURATION OF THE EXPRESSED WARRANTY SPECIFIED ABOVE.

2 Product Specific Information

A. Appliance Certification

MODEL: MEZZO36, MEZZO36ST, MEZZO48, MEZZO48ST, MEZZO60, MEZZO60ST, MEZZO72, MEZZO72ST
LABORATORY: Underwriters Laboratories, Inc. (UL)
TYPE: Direct Vent Heater
STANDARD: ANSI Z21.88-2014/CSA 2.33-2014

This product is listed to ANSI standards for “Vented Gas Fireplace Heaters” and applicable sections of “Gas Burning Heating Appliances for Manufactured Homes and Recreational Vehicles”, and “Gas Fired Appliances for Use at High Altitudes”.

NOTICE: This installation must conform with local codes. In the absence of local codes you must comply with the National Fuel Gas Code, ANSI Z223.1-latest edition in the U.S.A. and the CAN/CGA B149 Installation Codes in Canada.

NOT INTENDED FOR USE AS A PRIMARY HEAT SOURCE.

This appliance is tested and approved as either supplemental room heat or as a decorative appliance. It should not be factored as primary heat in residential heating calculations.



Installation and service of this appliance should be performed by qualified personnel. Hearth & Home Technologies recommends HHT Factory Trained or NFI certified professionals.



B. Glass Specifications

This appliance is equipped with 5 mm ceramic glass. Replace glass only with 5 mm ceramic glass. Please contact your dealer for replacement glass.

C. BTU Specifications

Models <i>(U.S. or Canada)</i>		Maximum Input BTU/h	Minimum Input BTU/h	Orifice Size (DMS)
MEZZO36 (NG)	<i>(0-2000 FT)</i>	30,000	17,500	#36
MEZZO36 (Propane)	<i>(0-2000 FT)</i>	29,000	15,500	#52
MEZZO36ST (NG)	<i>(0-2000 FT)</i>	30,000	17,500	#36
MEZZO36ST (Propane)	<i>(0-2000 FT)</i>	29,000	15,500	#52
MEZZO48 (NG)	<i>(0-2000 FT)</i>	40,000	21,000	.124
MEZZO48 (Propane)	<i>(0-2000 FT)</i>	36,000	19,500	#49
MEZZO48ST (NG)	<i>(0-2000 FT)</i>	40,000	21,000	.124
MEZZO48ST (Propane)	<i>(0-2000 FT)</i>	36,000	19,500	#49
MEZZO60 (NG)	<i>(0-2000 FT)</i>	50,000	26,000	#28
MEZZO60 (LP)	<i>(0-2000 FT)</i>	41,000	22,000	#48
MEZZO60ST (NG)	<i>(0-2000 FT)</i>	50,000	26,000	#28
MEZZO60ST (LP)	<i>(0-2000 FT)</i>	41,000	22,000	#48
MEZZO72 (NG)	<i>(0-2000 FT)</i>	58,000	30,000	#23
MEZZO72 (LP)	<i>(0-2000 FT)</i>	46,000	24,000	#45
MEZZO72ST (NG)	<i>(0-2000 FT)</i>	58,000	30,000	#23
MEZZO72ST (LP)	<i>(0-2000 FT)</i>	46,000	24,000	#45

3 Important Safety and Operating Information

A. Appliance Safety

WARNING! DO NOT operate fireplace before reading and understanding operating instructions. Failure to operate fireplace according to operating instructions could cause fire or injury.

 **DANGER**



HOT GLASS WILL CAUSE BURNS.

DO NOT TOUCH GLASS UNTIL COOLED.

NEVER ALLOW CHILDREN TO TOUCH GLASS.

- Keep children away.
- CAREFULLY SUPERVISE children in same room as fireplace.
- Alert children and adults to hazards of high temperatures.

High temperatures may ignite clothing or other flammable materials.

- Clothing, furniture, draperies, and other flammable materials must not be placed on or near the appliance.

A barrier designed to reduce the risk of burns from the hot viewing glass is provided with this appliance and shall be installed for the protection of children and other at-risk individuals. DO NOT operate the appliance with the barrier removed. If the barrier becomes damaged, the barrier shall be replaced with the manufacturer's barrier for this appliance.

Contact your dealer or Hearth & Home Technologies if the barrier is not present or help is needed to properly install one.

WARNING! Choking Hazard! Keep media out of reach of children.

Young children should be carefully supervised when they are in the same room as the appliance. Toddlers, young children and others may be susceptible to accidental contact burns.

- A physical barrier is recommended if there are at risk individuals in the house.
- To restrict access to a fireplace or stove, install an adjustable safety gate to keep toddlers, young children and other at risk individuals out of the room and away from hot surfaces.
- Install a switch lock or a wall/remote control with child protection lockout feature.

- Keep remote controls out of reach of children.
- Never leave children alone near a hot fireplace, whether operating or cooling down.
- Teach children to NEVER touch the fireplace.
- Consider not using the fireplace when children will be present.

Contact your dealer for more information, or visit: www.hpba.org/safety-information.

To prevent unintended operation when not using your fireplace for an extended period of time (summer months, vacations, trips, etc):

- Remove batteries from remote controls.
- Turn off wall controls.
- Unplug 6 volt adapter plug.

Clear Space

WARNING! DO NOT place combustible objects in front of the fireplace or block louvers. High temperatures may start a fire. See Figure 3.1.

Avoid placing candles and other heat-sensitive objects on mantel or hearth. Heat may damage these objects.

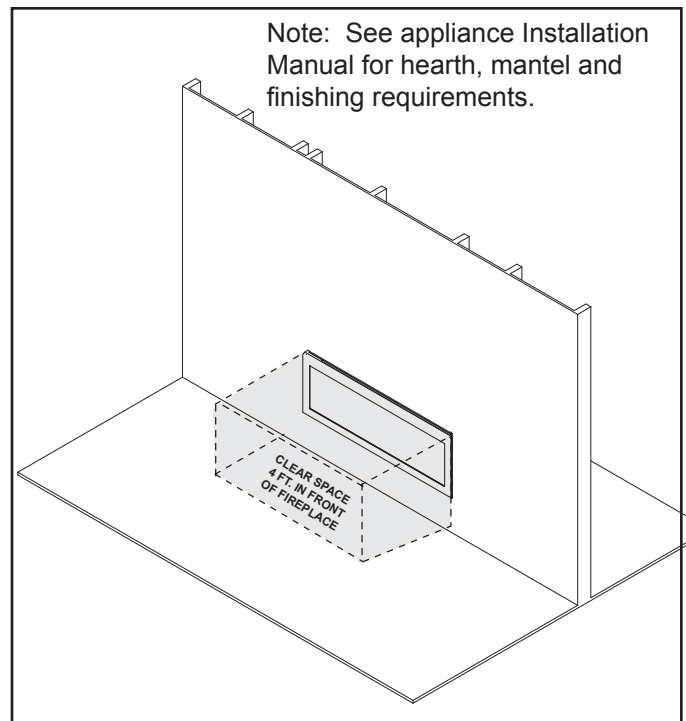

Figure 3.1 Clear Space

Over Firing

The appliance is considered to be over firing if the flames are contacting the top of the firebox. Call a qualified service technician to service the appliance.

B. General Operating Parts

Figure 3.2 references the general operating parts of the appliance and the section of this manual in which they are discussed.

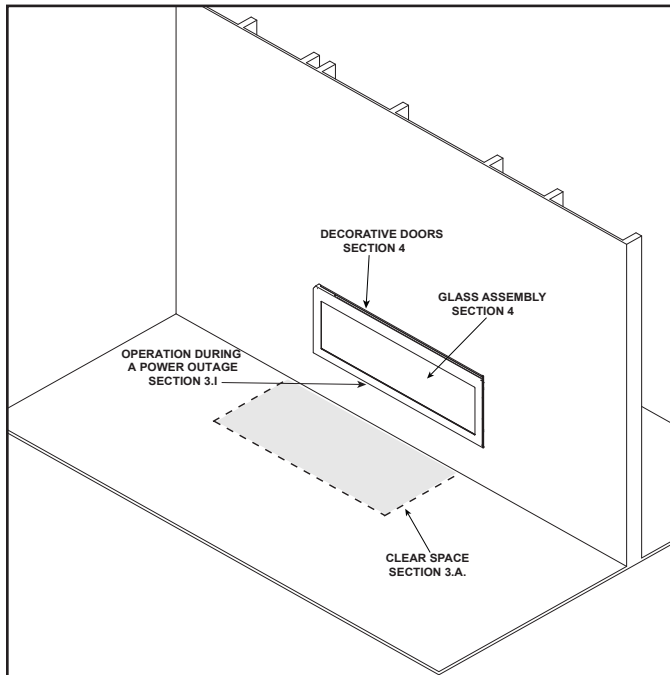

Figure 3.2 General Operating Parts

C. Fuel Specifications

WARNING! Risk of Fire or Explosion! Appliance must be set up for compatible gas type!

- This appliance is designed to operate on either natural gas or propane. Make sure the appliance is compatible with gas type selected for installation site.
- Conversions must be made by a qualified service technician using Hearth & Home Technologies specified and approved parts.

→ D. Good Faith Wall Surface/TV Guidelines

These are good faith estimates of the temperatures of the wall surface above the fireplace. Follow the installation instructions and comply with all minimum clearances to combustibles as specified. Finishing materials that comply with installation requirements can withstand these temperatures. Wall surface temperatures could vary depending on wall material and thickness. Refer to Figure 3.5 in regards to TV installation.

WARNING! Risk of Fire! Comply with all minimum clearances to combustibles as specified in the installation instructions.

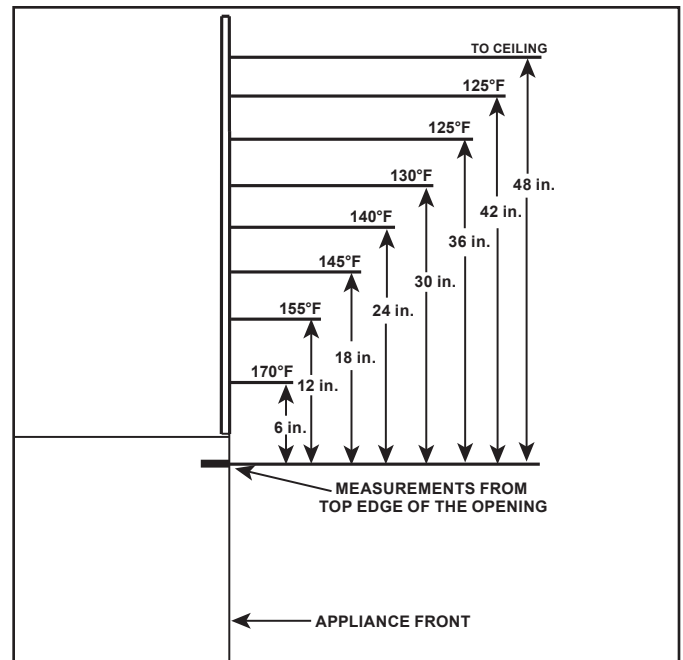

Figure 3.3. Wall Surface Temperatures Above Appliance (MEZZO36/MEZZO36ST/MEZZO48/MEZZO48ST)

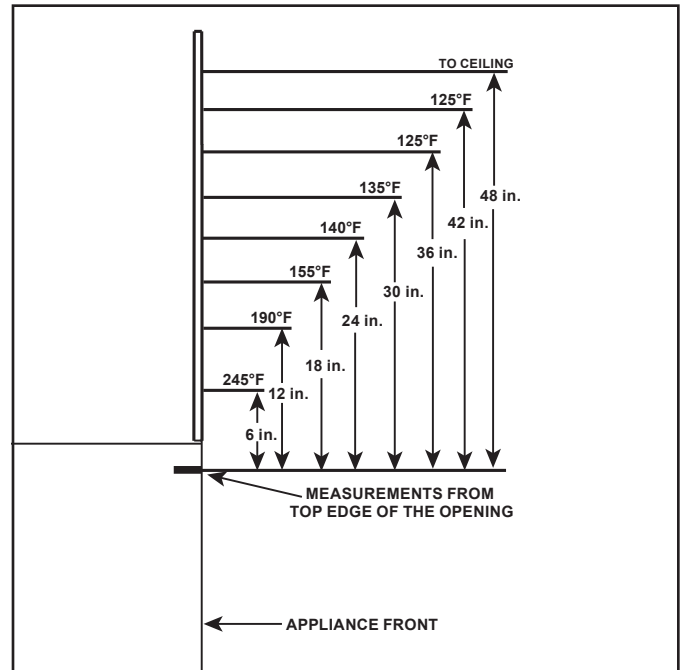
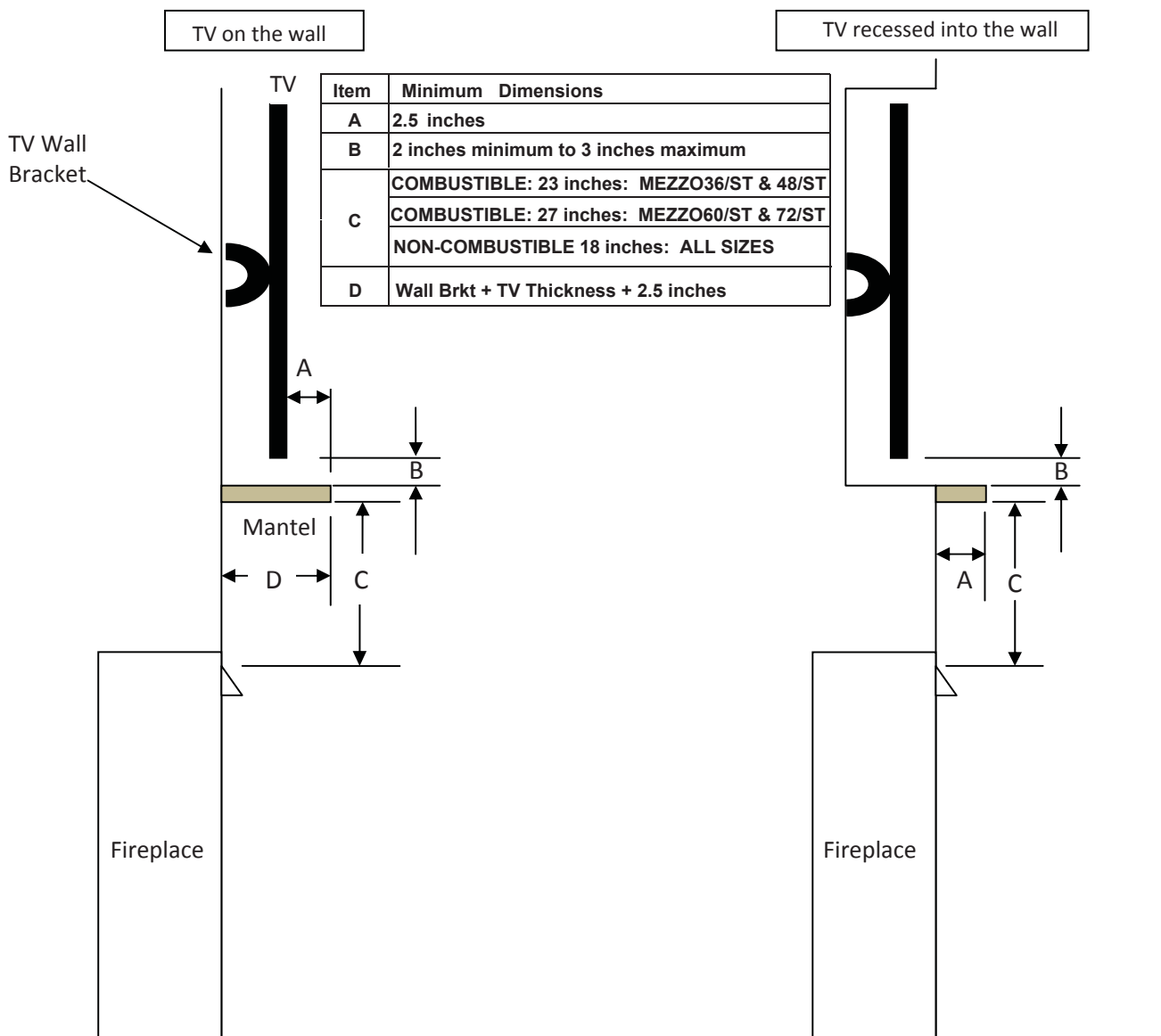

Figure 3.4. Wall Surface Temperatures Above Appliance (MEZZO60/MEZZO60ST/MEZZO72/MEZZO72ST)

NOTICE: Temperatures listed above are taken with a ← temperature measuring probe as prescribed by the test standard used for appliance certification. Temperatures on walls or mantels taken with an infrared thermometer may yield increased temperatures of up to 30 degrees or more depending on the thermometer settings and material characteristics being measured.

Good Faith Guidelines for TV Installations Above a Typical Gas Fireplace



Notes:

1. These are good faith recommended clearances only and not a guarantee of compliance with all TV manufacturers' maximum allowable operating temperatures.
2. Since every home has unique air flow characteristics and maximum allowable operating temperatures can vary from manufacturer to manufacturer and from model to model, actual TV temperatures should be validated at the time of each installation. TVs should not be used in situations where the actual TV temperature exceeds the manufacturers' maximum allowable operating temperatures identified in the TV's technical specifications. Contact the TV's manufacturer directly if you cannot locate this information or have questions regarding the information.
3. Mantel height and depth must conform to mantel requirements specified in the fireplace installation manual.
4. "C" dimension taken from the top of the hood or fireplace opening.
5. Suggestions on how to further reduce TV temperatures:
 - a. Increase "A" dimension.
 - b. Increase "C" dimension, however, increasing "B" dimension beyond maximum recommended typically results in higher temperatures.

Figure 3.5. Good Faith TV Guidelines

E. Before Lighting Appliance

Before operating this fireplace for the first time, **have a qualified service technician:**

- Verify all shipping materials have been removed from inside and/or underneath the firebox.
- Review proper placement of logs, ember material and/or other decorative materials.
- Check the wiring.
- Check the air shutter adjustment.
- Ensure that there are no gas leaks.
- Ensure that the glass is sealed and in the proper position and that the integral barrier is in place.

WARNING! Risk of Fire or Asphyxiation! DO NOT operate fireplace with fixed glass assembly removed.

F. Lighting Instructions (IPI)

FOR YOUR SAFETY READ BEFORE LIGHTING



WARNING: If you do not follow these instructions exactly, a fire or explosion may result causing property damage, personal injury or loss of life.

- A. This appliance is equipped with an intermittent pilot ignition (IPI) device which automatically lights the burner. **DO NOT** try to light the burner by hand.
 - B. **BEFORE LIGHTING**, smell all around the appliance area for gas. Be sure to smell next to the floor because some gas is heavier than air and will settle on the floor.
- WHAT TO DO IF YOU SMELL GAS**
- **DO NOT** try to light any appliance.
 - **DO NOT** touch any electric switch; do not use any phone in your building.
 - Immediately call your gas supplier from a neighbor's phone. Follow the gas supplier's instructions.
 - If you cannot reach your gas supplier, call the fire department.
- C. Use only your hand to push in or turn the gas control knob. Never use tools. If the knob will not push in or turn by hand, **DO NOT** try to repair it, call a qualified service technician. Force or attempted repair may result in a fire or explosion.
 - D. **DO NOT** use this appliance if any part has been under water. Immediately call a qualified service technician to inspect the appliance and to replace any part of the control system and any gas control which has been under water.

LIGHTING INSTRUCTIONS (IPI)

1. This appliance is equipped with an ignition device which automatically lights the burner. **DO NOT** try to light the burner by hand.
2. Wait five (5) minutes to clear out any gas. Then smell for gas, including near the floor. If you smell gas, **STOP!** Follow "B" in the Safety Information located on the top of this label. If you do not smell gas, go to next step.
3. To light the burner:
Equipped with wall switch: Turn ON/OFF switch to ON.
Equipped with remote or wall control: Press ON or FLAME button.
Equipped with thermostat: Set temperature to desired setting.
4. If the appliance does not light after three tries, call your service technician or gas supplier.

**GAS
VALVE**

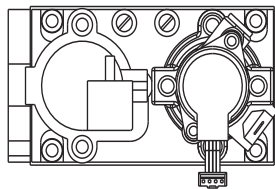

TO TURN OFF GAS TO APPLIANCE

1. Equipped with wall switch: Turn ON/OFF switch to OFF.
Equipped with remote or wall control: Press OFF button.
Equipped with thermostat: Set temperature to lowest setting.
2. Service technician should turn off electric power to the control when performing service.



DANGER



**HOT GLASS WILL CAUSE BURNS.
DO NOT TOUCH GLASS UNTIL COOLED.
NEVER ALLOW CHILDREN TO TOUCH GLASS.**

A barrier designed to reduce the risk of burns from the hot viewing glass is provided with this appliance and shall be installed for the protection of children and other at-risk individuals.

WARNING:

DO NOT CONNECT LINE VOLTAGE (110/120 VAC OR 220/240 VAC) TO THE CONTROL VALVE.

Improper installation, adjustment, alteration, service or maintenance can cause injury or property damage. Refer to the owner's information manual provided with this appliance. For assistance or additional information, consult a qualified installer, service agency or the gas supplier.

This appliance needs fresh air for safe operation and must be installed so there are provisions for adequate combustion and ventilation air.

If not installed, operated, and maintained in accordance with the manufacturer's instructions, this product could expose you to substances in fuel or fuel combustion which are known to the State of California to cause cancer, birth defects, or other reproductive harm.

Keep burner and control compartment clean. See installation and operating instructions accompanying appliance.

CAUTION:

Hot while in operation. **DO NOT** touch. Keep children, clothing, furniture, gasoline and other liquids having flammable vapors away.

DO NOT operate the appliance with fixed glass assembly removed, cracked or broken. Replacement of the fixed glass assembly should be done by a licensed or qualified service person.

NOT FOR USE WITH SOLID FUEL

For use with natural gas and propane. A conversion kit, as supplied by the manufacturer, shall be used to convert this appliance to the alternate fuel.

Also Certified for Installation in a Bedroom or a Bedding Room.

This appliance must be installed in accordance with local codes, if any; if none, follow the *National Fuel Gas Code, ANSI Z223.1/NFPA 54, or the National Gas and Propane Installation code, CSA B149.1.*

For additional information on operating your
Hearth & Home Technologies fireplace, please refer to www.fireplaces.com.

593-913i

G. Appliance Break-In

Initial Break-in Procedure

- The fireplace should be run three to four hours continuously on high.
- Turn the fireplace off and allow it to completely cool.
- Remove fixed glass assembly. See Section 4.
- Clean fixed glass assembly. See Section 4.
- Replace the fixed glass assembly and run continuously on high an additional 12 hours.

This cures the materials used to manufacture the fireplace.

NOTICE! Open windows for air circulation during fireplace break-in.

- *Some people may be sensitive to smoke and odors.*
- *Smoke detectors may activate.*

H. Heat Management

Burn Rate

The MEZZO models have a variable burn rate which is controlled by the remote control. Therefore the flame height is adjustable.

The flame height may be adjusted as desired by locating the flame option on the remote control and adjusting up or down to desired flame height.

I. Operation During A Power Outage

The IntelliFire™ Plus intermittent pilot ignition system comes with a battery backup system that enables the system to operate in a power outage. The system offers seamless transition from household AC power to battery backup. A factory-installed battery pack is located in the control cavity of the appliance. See Figure 3.6. Battery longevity and performance will be affected by long term exposure to the service temperatures of this appliance.

NOTICE: Batteries should only be used as a power source in the event of an emergency power outage. Batteries should not be used as a primary long-term power source.

To Operate Fireplace Using Battery Power (DC):

1. Access the control cavity of the appliance. See Figure 3.6 for location. Lift the decorative front off of the appliance and lift the vanity panel out of the bottom of the glass frame.
2. Locate the battery tray and insert four AA cell batteries. See Figure 3.7. Battery polarity must be correct or module damage will occur. A complete wiring diagram is included in the Electrical section of the appliance Installation Manual.
3. Turn the appliance on according to the instructions below for the appropriate type of control:

Standard Wall Switch or Factory-Installed ON/OFF Switch:

- Toggle the switch as you would under normal circumstances.

Wireless Remote:

- Remote receiver is integrated into the ignition module
- Use the remote to turn the appliance on.
- To preserve battery life, do not use the HI/LO flame or THERMOSTAT options.

Ignition Module:

- Locate the ignition module in the control cavity.
- Slide the ON/REMOTE/OFF switch to the ON position.

NOTICE: Some functionality will be lost when using battery backup including remote control, lights, or any other auxiliary functions that require household 110-120 VAC power.

To Return to Operation Using Electrical (AC) Power

Standard Wall Switch or Factory-Installed ON/OFF Switch:

- Remove screws on left and right sides of component heat shield and lift it out of the control cavity.
- Toggle the switch to OFF and remove the batteries from the battery tray. Replace door or decorative front on appliance.

Wireless Remote:

- Remove screws on left and right sides of component heat shield and lift it out of the control cavity.
- Slide the ON/REMOTE/OFF switch to the REMOTE position. Remove the batteries from the battery tray. Replace door or decorative front on appliance.
- Reinstall component heat shield.

CAUTION! Risk of Overheating! Component heat shield **MUST** be installed before operating appliance. Electrical components will be damaged.

Ignition Module:

- Remove screws on left and right sides of component heat shield and lift it out of the control cavity.
- Slide the ON/REMOTE/OFF switch to the REMOTE position.
- Reinstall component heat shield.
- Remove the batteries from the battery tray. Replace door or decorative front on appliance.

CAUTION! Risk of Overheating! Component heat shield **MUST** be installed before operating appliance. Electrical components will be damaged.

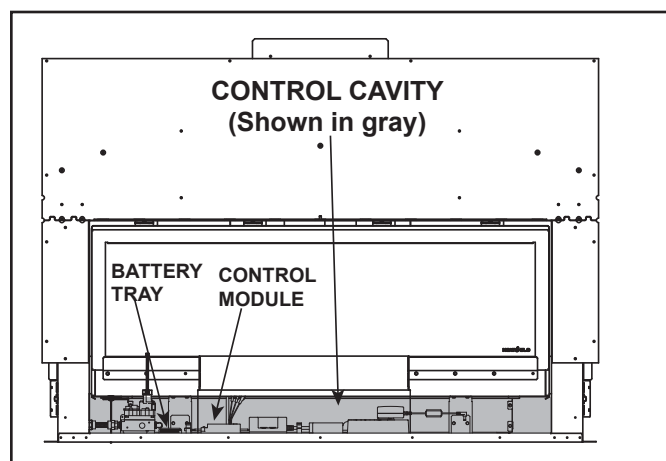

3.6 Control Cavity Location

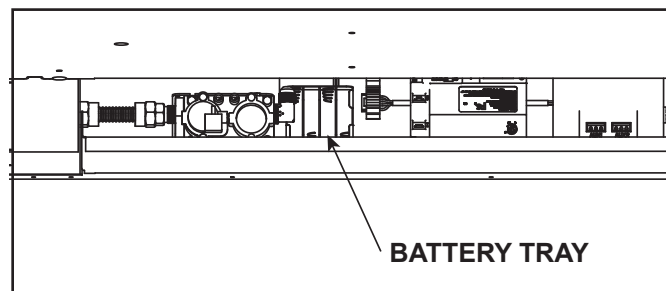

3.7 Battery Tray Location - Top View

J. Detailed Component Operating Instructions - IntelliFire™ Plus

Control Module Operation

1. The control module has an ON/OFF/REMOTE selector switch that must be set. See Figure 3.8.

OFF Position: Appliance will ignore all power inputs and will not respond to any commands from a wall switch or remote. The unit should be in the OFF position during installation, service, battery installation, fuel conversion, and in the event that the control goes into LOCK-OUT mode as a result of an error code.

ON Position: Appliance will ignite and run continuously in the HI flame setting, with no adjustment in flame output. This mode of operation is primarily used for initial installation or power outage operation with battery backup.

REMOTE Position: Appliance will initiate commands from an optional wired wall switch and/or the wireless remote (RC300).

2. If using a wired wall switch with the module in REMOTE mode, the flame output can be adjusted with the HI/LO selector switch on the module. See Figure 3.8. Note that the flame HI/LO selector switch will become inactive once an optional remote control (RC200/RC300) is programmed to the control module. Note that the control module will always ignite the fireplace on HI and remain so for the initial 10 seconds of operation. If the HI/LO is switched to the LO position, the flame output will automatically drop to the lowest setting after the flame has been established for 10 sec. After this 10 second period, the flame can be adjusted from HI to LO with the switch.
3. The control module has safety feature that automatically shuts down the fireplace after 9 hours of continuous operation without receiving a command from the RC300 remote.
4. If you intend to use both an optional wired wall switch and the RC300 remote control to operate your fireplace, the wall switch will override any commands given by the remote.

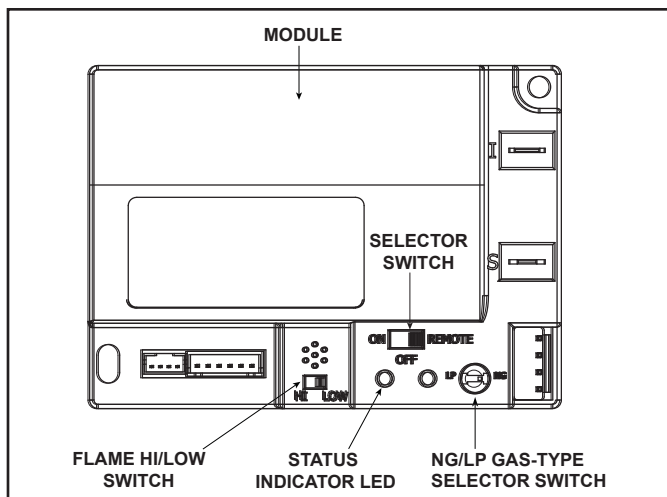

Figure 3.8 Control Module

5. Module Reset

This module may lock-out under certain conditions. When this occurs, the appliance will not ignite or respond to commands. The module will go into lock-out mode by emitting three audible beeps, then continuously displaying a RED/GREEN error code at its status indicator LED.

- Check battery tray. Remove batteries if installed. Batteries should only be installed for use during power outages. See Section H.
- Locate the module selector switch. (See Figure 3.8).
- Set the module selector switch to the OFF position.
- Wait five (5) minutes to allow possible accumulated gas to clear.
- Set the module selector switch to ON or REMOTE position.
- Start the appliance.

WARNING! Risk of Explosion! DO NOT press the module reset switch more than one time within a five minute time period. Gas could accumulate in firebox. Call a qualified service technician.

Nine Hour Safety Shutdown Feature

The appliance has a safety feature that automatically shuts down the fireplace after nine hours of continuous operation without receiving a command from the wall switch or optional remote.

Appliance ON/OFF

Use the IntelliFire™ Plus Remote Control to control the ON/OFF function of the appliance. Follow instructions included with the installed control. If desired, a wall switch may be installed to control the ON/OFF function of the appliance.

LED Lighting

The ON/OFF function for the LED lighting option is controlled by the IntelliFire™ Plus remote control. Follow instructions included with the installed control.

4 Maintenance and Service

Any safety screen or guard removed for servicing must be replaced prior to operating the fireplace.

When properly maintained, your fireplace will give you many years of trouble-free service. **Contact your dealer** to answer questions regarding proper operation, troubleshooting and service for your appliance. Visit www.heatnglo.com to locate a dealer. We recommend annual service by a qualified service technician.

A. Maintenance: Frequency and Tasks

The matrix below is an overview of maintenance tasks to be performed on the appliance. Sections B and C give details and instructions needed to assist the appropriate person in performing the tasks.

Task	Frequency	To be completed by
Glass Cleaning	Seasonally	Homeowner
Doors/Fronts/Surrounds	Annually	
Remote Control	Seasonally	
Venting	Seasonally	
Gasket Seal and Glass Inspection	Annually	Qualified Service Technician
Log Inspection	Annually	
Firebox Inspection	Annually	
Control Compartment & Firebox Top	Annually	
Burner Ignition & Operation	Annually	

B. Maintenance Tasks: Homeowner

Installation and repair should be done by a qualified service technician only. The fireplace should be inspected before use and at least annually by a professional service person.

The following tasks may be performed annually by the homeowner. If you are uncomfortable performing any of the listed tasks, please call your dealer for a service appointment.

More frequent cleaning may be required due to lint from carpeting or other factors. Control compartment, burner and circulating air passageway of the fireplace must be kept clean.

CAUTION! Risk of Burns! The fireplace should be turned off and cooled before servicing.

Glass Cleaning

Frequency: Seasonally

By: Homeowner

Tools Needed: Protective gloves, glass cleaner, drop cloth and a stable work surface.

WARNING! Handle fixed glass assembly with care. Glass is breakable. Inspect the gasket to ensure it is undamaged and inspect the glass for cracks, chips or scratches.

- Avoid striking, scratching or slamming glass
 - Avoid abrasive cleaners
 - **DO NOT** clean glass while it is hot
 - Replace as a complete assembly.
- Prepare a work area large enough to accommodate fixed glass assembly and door frame by placing a drop cloth on a flat, stable surface.

Note: Fixed glass assembly and gasketing may have residue that can stain carpeting or floor surfaces.

Removing Fixed Glass Assembly

1. Remove the decorative front from fireplace and set aside on work surface.
2. Locate the glass spring latches that are on the upper edge of the glass frame of the appliance. See Figure 4.1.
3. Use both index fingers to release spring latches. See Figure 4.1.
4. Allow glass to tilt forward. Grasp glass on the upper return lip of glass frame and lift up and out. The glass should lift easily out of the bottom retaining lip.

Cleaning Fixed Glass Assembly

- Clean glass with a non-abrasive commercially available cleaner.
 - Light deposits: Use a soft cloth with soap and water
 - Heavy deposits: Use commercial fireplace glass cleaner (consult with your dealer)
- Carefully set fixed glass assembly in place on fireplace. Hold glass in place with one hand and secure glass latches with the other hand.
- Reinstall door or decorative front.

Replacing Fixed Glass Assembly

1. Locate retaining lip on lower front face of firebox.
2. Place glass assembly into retaining lip end. Tilt top of glass assembly toward fireplace.
3. Assure proper left and right placement of glass and engage all four spring latches.

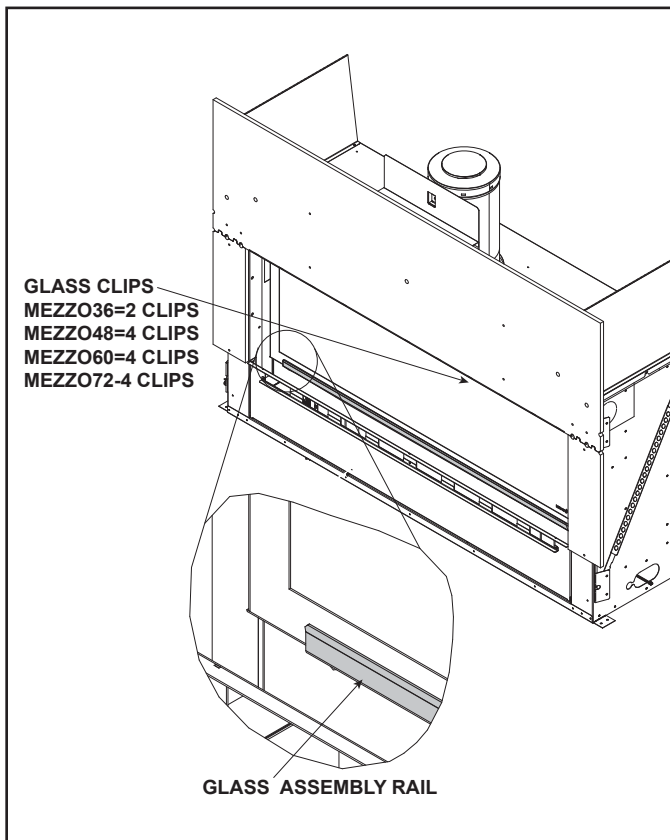

Figure 4.1 Fixed Glass Assembly

Doors, Surrounds, Fronts

Frequency: Annually

By: Homeowner

Tools needed: Protective gloves, stable work surface

- Assess condition of screen and replace as necessary.
- Inspect for scratches, dents or other damage and repair as necessary.
- Check that louvers are not blocked.
- Vacuum and dust surfaces.

Remote Control

Frequency: Seasonally

By: Homeowner

Tools needed: Replacement batteries and remote control instructions.

- Locate remote control transmitter and receiver.
- Verify operation of remote. Refer to remote control operation instructions for proper calibration and setup procedure.
- Place batteries as needed in remote transmitters and battery-powered receivers.
- Place remote control out of reach of children.

If not using your fireplace for an extended period of time (summer months, vacations/trips, etc), to prevent unintended operation:

- Remove batteries from remote controls.
- Unplug 6 volt adapter plug on IPI models.

Venting

Frequency: Seasonally

By: Homeowner

Tools needed: Protective gloves and safety glasses.

- Inspect venting and termination cap for blockage or obstruction such plants, bird nests, leaves, snow, debris, etc.
- Verify termination cap clearance to subsequent construction (building additions, decks, fences, or sheds).
- Inspect for corrosion or separation.
- Verify weather stripping, sealing and flashing remains intact.
- Inspect draft shield to verify it is not damaged or missing.

C. Maintenance Tasks: Qualified Service Technician

The following tasks must be performed by a qualified service technician.

Gasket Seal and Glass Assembly Inspection

Frequency: Annually

By: Qualified Service Technician

Tools needed: Protective gloves, drop cloth and a stable work surface.

- Inspect gasket seal and its condition.
- Inspect fixed glass assembly for scratches and nicks that can lead to breakage when exposed to heat.
- Confirm there is no damage to glass or glass frame. Replace as necessary.
- Verify that fixed glass assembly is properly retained and attachment components are intact and not damaged. Replace as necessary.

Firebox

Frequency: Annually

By: Qualified Service Technician

Tools needed: Protective gloves, sandpaper, steel wool, cloths, mineral spirits, primer and touch-up paint.

- Inspect for paint condition, warped surfaces, corrosion or perforation. Sand and repaint as necessary.
- Replace fireplace if firebox has been perforated.

Control Compartment and Firebox Top

Frequency: Annually

By: Qualified Service Technician

Tools needed: Protective gloves, vacuum cleaner, dust cloths

- Vacuum and wipe out dust, cobwebs, debris or pet hair. Use caution when cleaning these areas. Screw tips that have penetrated the sheet metal are sharp and should be avoided.
- Remove all foreign objects.
- Verify unobstructed air circulation.

Burner Ignition and Operation

Frequency: Annually

By: Qualified Service Technician

Tools needed: Protective gloves, vacuum cleaner, whisk broom, flashlight, voltmeter, indexed drill bit set, and a manometer.

- Verify burner is properly secured and aligned with pilot or igniter.
- Clean off burner top, inspect for plugged ports, corrosion or deterioration. Replace burner if necessary.
- Inspect for lifting or other flame problems.
- Verify air shutter setting is correct. See Installation Manual for required air shutter setting. Verify air shutter is clear of dust and debris.
- Inspect orifice for soot, dirt and corrosion. Verify orifice size is correct. See Service Parts List for proper orifice sizing.
- Verify manifold and inlet pressures. Adjust regulator as required.
- Inspect pilot flame pattern and strength. See Figure 4.2 for proper pilot flame pattern. Clean or replace orifice spud as necessary.
- Inspect IPI flame sensing rod for soot, corrosion and deterioration. Polish with fine steel wool or replace as required.
- Verify IPI millivolt output. Replace as necessary.
- Verify that there is not a short in flame sense circuit by checking continuity between pilot hood and flame sensing rod. Replace pilot as necessary.

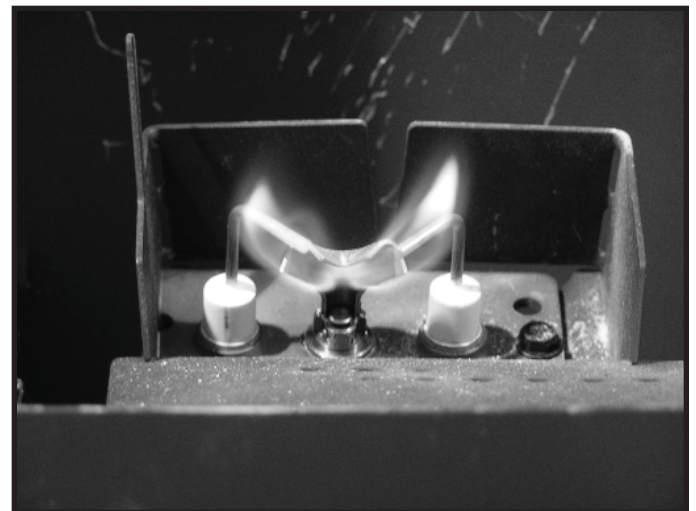

Figure 4.2 IPI Pilot Flame Patterns

5 Frequently Asked Questions and Troubleshooting

A. Frequently Asked Questions

ISSUE	SOLUTIONS
Condensation on the glass	This is a result of gas combustion and temperature variations. As the fireplace warms, this condensation will disappear.
Blue flames	This is a result of normal operation and the flames will begin to yellow as the fireplace is allowed to burn for 20 to 40 minutes.
Odor from fireplace	When first operated, this fireplace may release an odor for the first several hours. This is caused by the curing of materials from manufacturing. Odor may also be released from finishing materials and adhesives used near the fireplace. These circumstances may require additional curing related to the installation environment.
Film on the glass	This is a normal result of the curing process of the paint. Glass should be cleaned within 3 to 4 hours of initial burning. A non-abrasive cleaner such as gas appliance glass cleaner may be necessary. See your dealer.
Metallic noise	Noise is caused by metal expanding and contracting as it heats up and cools down, similar to the sound produced by a furnace or heating duct. This noise does not affect the operation or longevity of the fireplace.
Rock noise	There may be some "cracking" noise coming from the fireplace during the first few heating and cooling cycles. This noise is associated with settling rock and some minor cracking of larger pieces of rock. This will lessen over time as the glass rock is conditioned to the heating and cooling temperature changes.
Rocks falling through basepan	It is expected that a few small pieces of rock may fall through the basepan and come to rest on the fireplace bottom. This has no affect on fireplace performance.
Wall above appliance feels hot to the touch.	No action necessary. This appliance ships with a non-combustible material attached. Specifications of the attached non-combustible material are listed in the appliance installation manual.

Contact your dealer for additional information regarding operation and troubleshooting. Visit www.heatnglo.com to locate a dealer.

B. Troubleshooting

With proper installation, operation, and maintenance your gas appliance will provide years of trouble-free service. If you do experience a problem, this troubleshooting guide will assist a qualified service technician in the diagnosis of a problem and the corrective action to be taken. This troubleshooting guide can only be used by a qualified service technician. Contact your dealer to arrange a service call by a qualified service technician.

IntelliFire™ Plus Ignition System

Symptom	Possible Cause	Corrective Action
1. Pilot won't light. The ignitor/module makes noise, but no spark.	A. Incorrect wiring.	Verify "S" wire (white) for sensor and "I" wire (orange) for ignitor are connected to correct terminals on module and pilot assembly.
	B. Loose connections or electrical shorts in the wiring.	Verify no loose connections or electrical shorts in wiring from module to pilot assembly. Verify connections underneath pilot assembly are tight; also verify igniter and flame sense wires are not grounding out to metal chassis, pilot burner, pilot enclosure, mesh screen if present, or any other metal object.
	C. Ignitor gap is too large.	Verify gap of igniter to right side of pilot hood. The gap should be approximately .095 in. (2.41 mm) to .135 in. (3.43 mm).
2. Pilot won't light, there is no noise or spark.	A. No power, transformer installed incorrectly, or depleted batteries.	Verify that transformer is installed and plugged into module. Check voltage of transformer at connection to module. Acceptable readings of a good transformer are between 6.4 and 6.6 volts DC. Battery power supply voltage must be at least 4 volts. If less than 4 volts, replace batteries.
	B. A shorted or loose connection in wiring configuration or wiring harness.	Remove and reinstall the wiring harness that plugs into module. Verify there is a tight fit. Verify pilot assembly wiring to module. Remove and verify continuity of each wire in wiring harness. Replace any damaged components.
	C. Improper wall switch wiring.	Verify that 110-120 VAC power is "ON" to junction box.
	D. Module not grounded.	Verify black ground wire from module wire harness is grounded to metal chassis of appliance.
3. Pilot sparks, but Pilot will not light.	A. Gas supply.	Verify that incoming gas line ball valve is "open". Verify that inlet pressure reading is within acceptable limits.
	B. Ignitor gap is too large.	Verify gap of igniter to right side of pilot hood. The gap should be approximately .095 in. (2.41 mm) to .135 in. (3.43 mm).
	C. Module is not grounded.	Verify module is securely grounded to metal chassis of appliance.
	D. Pilot valve solenoid.	Verify that 1.5 to 1.8 VDC is supplied to pilot solenoid from module. If below 1.5 volts, replace module. If 1.5 volts or greater, replace valve.

Intellifire™ Plus Ignition System - (continued)

Symptom	Possible Cause	Corrective Action
4. Pilot lights but continues to spark, and main burner will not ignite. (If the pilot continues to spark after the pilot flame has been lit, flame rectification has not occurred.)	A. A shorted or loose connection in flame sensing rod.	Verify all connections to wiring diagram in manual. Verify connections underneath pilot assembly are tight. Verify flame sense or igniter wires are not grounding out to metal chassis, pilot burner, pilot enclosure or screen if present, or any other metal object.
	B. Poor flame rectification or contaminated flame sensing rod.	With fixed glass assembly in place, verify that flame is engulfing flame sensing rod on left side of pilot hood. Flame sensing rod should glow shortly after ignition. With a multi-meter, verify that current in series between module and sense lead is at least 0.14 microamps. Verify correct pilot orifice is installed and gas inlet is set to pressure specifications. Polish flame sensing rod with fine steel wool to remove any contaminants that may have accumulated on flame sensing rod.
	C. Module is not grounded.	Verify module is securely grounded to metal chassis of appliance. Verify that wire harness is firmly connected to the module.
	D. Damaged pilot assembly or contaminated flame sensing rod.	Verify that ceramic insulator around the flame sensing rod is not cracked, damaged, or loose. Verify connection from flame sensing rod to white sensor wire. Polish flame sensing rod with fine steel wool to remove any contaminants that may have accumulated on flame sensing rod. Verify continuity with a multi-meter with ohms set at lowest range. Replace pilot if any damage is detected.
5. Appliance lights and runs for a few minutes and then shuts down and/or appliance cycles on and off.	A. A shorted or loose connection in flame sensing rod.	Verify all connections to wiring diagram in manual. Verify connections underneath pilot assembly are tight. Verify flame sense or igniter wires are not grounding out to metal chassis, pilot burner, pilot enclosure or screen if present, or any other metal object.
	B. Poor flame rectification or contaminated flame sensing rod.	With fixed glass assembly in place, verify that flame is engulfing flame sensing rod on left side of pilot hood. Flame sensing rod should glow shortly after ignition. With a multi-meter, verify that current in series between module and sense lead is at least 0.14 microamps. Verify correct pilot orifice is installed and gas inlet is set to pressure specifications. Polish flame sensing rod with fine steel wool to remove any contaminants that may have accumulated on flame sensing rod.
	C. Logs are set up incorrectly.	Remove and reinstall logs per the log placement instructions.
	D. Damaged pilot assembly or contaminated flame sensing rod.	Verify that ceramic insulator around the flame sensing rod is not cracked, damaged, or loose. Verify connection from flame sensing rod to white sensor wire. Polish flame sensing rod with fine steel wool to remove any contaminants that may have accumulated on flame sensing rod. Verify continuity with a multi-meter with ohms set at lowest range. Replace pilot if any damage is detected.

6 Reference Materials

A. Accessories

Install approved accessories per instructions included with accessories. Contact your dealer for a list of approved accessories.

WARNING! Risk of Fire and Electric Shock! Use ONLY Hearth & Home Technologies-approved optional accessories with this appliance. Using non-listed accessories could result in a safety hazard and will void the warranty.

Remote Controls, Wall Controls and Wall Switches

After a qualified service technician has installed the remote control or wall switch, follow the instructions supplied with the control installed to operate your fireplace:

For safety:

- Install a switch lock or a wall/remote control with child protection lockout feature.
- Keep remote controls out of reach of children.

See your dealer if you have questions.

Optional Heat-Zone® Kit

After a qualified service technician has installed the Heat-Zone® Kit, follow the instruction supplied with the kit for operation. See your dealer if you have questions.

