

Direct Vent Gas Fireplaces

CAPTIVATING BEAUTY.  
INVITING WARMTH.







**JUST YOUR STYLE.** With a variety of options, ranging from specialty and contemporary to more traditional styles, you're sure to discover the perfect Majestic direct vent gas fireplace to complement your new home or addition.

500DVB shown with Tavern Brown firebrick (p. 6)  
On Cover: Solitaire shown with contemporary  
stone and fireglass (p. 8)



# ALL OUR MAJESTIC DIRECT VENT GAS FIREPLACES OFFER GREAT FEATURES INCLUDING

## WIDE VIEWING AREAS

Designed to deliver a beautiful flame picture, all of our fireplaces provide an expansive view of the fire that will delight friends and family.

## WARMTH AND COMFORT

No matter which style you choose, you can depend on Majestic fireplaces to deliver ample BTUs to help heat your home for years to come.

## EXCLUSIVE SIGNATURE COMMAND® SYSTEM

Enjoy the ultimate in fireplace control, featuring a touch screen remote\* and 3-step flame height adjustment. With electronic ignition, this system lights the pilot only when you turn it on to help save energy. And, with automatic battery back-up, you can be assured of fireplace operation even if the power goes out.

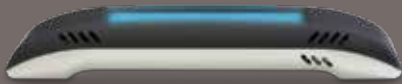

Look for Total Signature Command® on select models, featuring the exclusive Smart Mode® thermostat for enhanced energy efficiency, rear burner shut down and more!

Learn more about Signature Command® options on the back cover.

## SAFETY FIRST

Because our fireplaces were designed to deliver maximum BTUs to provide the best heating solutions for your home, the units will become hot to the touch. Consequently, all Majestic direct vent fireplaces come standard with a certified safety barrier. The screen barrier affixes to your fireplace and has been approved by a third party testing agency to conform to specific standards designed to prevent injury from hot glass.

**CERTIFIED**  
**SAFETY BARRIER**



DVB shown without firebrick (p. 6)



Cameo shown with Tavern Brown firebrick (p. 10)



Pearl see-thru shown with log set, Cottage Red firebrick and optional light kit (p. 13)

## PATRIOT

# EVOKE EFFORTLESS GRACE

A flexible, easy to install fireplace with a host of options, the Patriot model makes customizing your space effortless. Create a traditional look with standard logs and your choice of firebrick, or update to a more contemporary feel with a Black porcelain liner and glass and stone media.



Patriot shown with Cottage Red firebrick

### PATRIOT QUICK LOOK

Sizes	33", 36", 42"
Heating Capacity	Up to 900 sq. ft.
Max BTUs	Up to 24,000
Thermal Efficiency	Up to 78%
Control System	IPI or Millivolt
Safety Screen Barrier	Included
160 cfm Blower	Optional



### ADDITIONAL FEATURES

- Flexible installation — The Patriot fireplace ships with a traditional log set, ready to add your choice of firebrick or porcelain panels. Swap the log set for a stone and fireglass kit or fireglass for a contemporary look at a cost effective price.
- Safety screen barrier
- Optional battery back up kit (for IPI models)
- Optional remote three step flame control



Safety Screen Barrier (standard)

### DESIGN OPTIONS

#### Interior Firebrick



Tavern Brown



Cottage Red

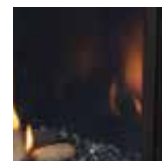

Black Porcelain

#### Fireglass

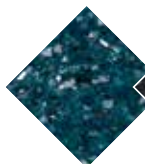

Sapphire

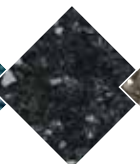

Onyx

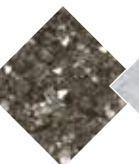

Bronze

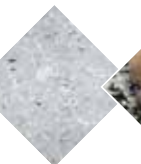

Diamond



Stone and Fireglass Kit



Patriot shown with contemporary stone and fireglass kit



**DVB**

# ELICIT TIMELESS BRILLIANCE

With three sizes to choose from, the DVB Series fireplace provides a reliable heat source for any room. Its classic style features optional firebrick and trim packages, so you can create just the look you desire.



400DVB without firebrick

### DVB QUICK LOOK

Sizes	33", 36", 42"
Heating Capacity	Up to 1,020 sq. ft.
Max BTUs	26,000
Thermal Efficiency	Up to 80%
Control System	Signature Command® or Millivolt
Safety Barrier Screen	Included
160 cfm Blower	Optional

### ADDITIONAL FEATURES

- Natural Flame burner system
- Deluxe control panel
- Safety barrier screen



Safety Screen Barrier (standard)

### DESIGN OPTIONS

#### Interior Firebrick



Cottage Red



Tavern Brown

#### Trim



Black Trim available in Medium (shown) and Curved styles

### CABINET OPTIONS

#### Cabinet Options for 33" and 36" DVB



Barrington Dark Walnut Wall Cabinet



Barrington Unfinished Walnut Wall Cabinet

#### Cabinet Options for 36" and 42" DVB



Honey Oak Wall or Corner Cabinet



Dark Cherry Wall or Corner Cabinet



Unfinished Birch Wall or Corner Cabinet (Available in corner styles by special color)



Unfinished Oak Wall or Corner Cabinet (Available in corner styles by special color)



500DVB without firebrick

DVB

7

**SOLITAIRE**

## DESIGN A SINGULAR STUNNER

The clean, contemporary Solitaire fireplace comes in three sizes to fit your decor. Create a custom look — Solitaire fireplaces let you stretch your imagination with a wide variety of accessories. Develop your style with alternate firebrick choices, or create a dramatic, modern focal point using our optional stone and fireglass kits.



Solitaire shown with Black porcelain panels and contemporary stone and fireglass kit

### SOLITAIRE QUICK LOOK

Sizes	33", 36", 42"
Heating Capacity	Up to 1,175 sq. ft.
Max BTUs	27,000
Thermal Efficiency	Up to 80%
Control System	Signature Command®
Safety Screen Barrier	Included
160 cfm Blower	Optional



Safety Screen Barrier (standard)





Solitaire shown with  
Olde English Firebrick



Solitaire shown with Black porcelain liner,  
contemporary stone and fireglass kit and  
contemporary flush face (available for 33"  
and 36" models only)



Solitaire shown with Black porcelain panels  
and contemporary fireglass Kit.

### ADDITIONAL FEATURES

- Ember bed burner
- Deluxe control panel
- Removable unitized black louver assembly for ease of installation
- Available as a dedicated top vent unit
- Safety screen barrier

### DESIGN OPTIONS

#### Interior Firebrick



Cottage Red



Tavern Brown



Olde English

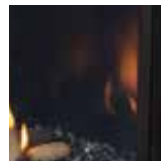

Black Porcelain

#### Fireglass

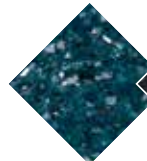

Sapphire

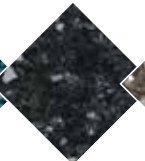

Onyx

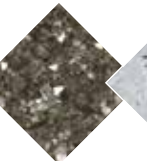

Bronze

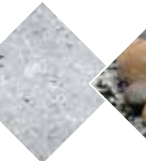

Diamond



Stone and  
Fireglass Kit



Stone and fireglass kit



Fireglass kit



Logs shown with black  
porcelain liner

## CAMEO

# INSPIRE CLASSIC STYLE

With a more traditional design including louvers and a realistic log set, you can achieve a classic look that becomes a centerpiece for your home. Plus, the large format provides a wide viewing area that showcases the dancing flames from anywhere in the room.



## DESIGN OPTIONS

### Interior Firebrick



Tavern Brown

### Finishing



Black trim available in curved style

## CAMEO QUICK LOOK

Sizes	42", 47"
Heating Capacity	Up to 1,600 sq. ft.
Max BTUs	32,000
Thermal Efficiency	Up to 80%
Control System	Signature Command®
Safety Screen Barrier	Included
160 cfm Blower	Optional



Safety Screen Barrier (standard)





Cameo shown with  
Tavern Brown firebrick



Pearl corner shown with Black porcelain panels and contemporary stone and fireglass kit



Pearl peninsula shown with log set, Cottage Red firebrick, and accent light

(Cabinet not available.)

### PEARL QUICK LOOK

Styles	See-Thru, Corner, Peninsula
Heating Capacity	1,450 sq. ft.
Max BTUs	25,000 – 37,000
Thermal Efficiency	Up to 80%
Control System	Signature Command®
Safety Screen Barrier	Included
160 cfm Blower	Optional



#### Standard Safety Screen Barriers

(Corner and see-thru include two, peninsula includes three.)

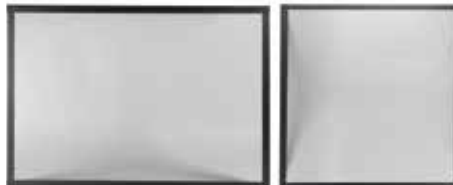



**PEARL DESIGNER SERIES**

## CREATE AMBIENCE THREE WAYS

With three different configuration options – See-Thru, Corner and Peninsula – the Pearl Designer Series adds a dramatic accent to any room, no matter how you look at it. Each style provides an expansive view of the fire from multiple sides, while interior options like contemporary fireglass, stone and light kits transform your fireplace into a statement piece, even when it isn't burning.

specialty ◇ model



Pearl see-thru shown with log set, Cottage Red firebrick and accent light

### DESIGN OPTIONS

#### Interior Firebrick



Cottage Red



Olde English

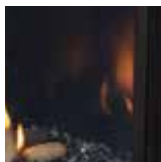

Black Porcelain

#### Fireglass

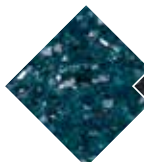

Sapphire

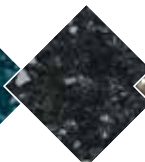

Onyx

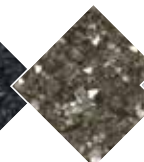

Bronze

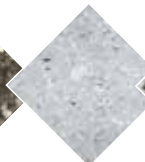

Diamond



Stone and Fireglass Kit

Note: Glass kits include one 2.25 lb. bag. Designer units require two bags.

**MAJESTIC DIRECT VENT SYSTEMS LINEUP**

MODEL	PATRIOT			DVB		
SIZES	33"	36"	42"	33"	36"	42"
Model Numbers	33CFDV	36CFDV	42CFDV	300DVB	400DVB	500DVB
Standout Feature	Easily convertible from a traditional to a contemporary look.			Many choices for finishing to fit any decor		
Control System	IPI or Millivolt Control			Signature Command® or Millivolt		
Max heating capacity (sq ft)	600	735	900	835	940	1,015
Viewing style	Front, Clean Face			Front		
Maximum viewing area (sq in)	540	580	660	486	591	672
Max BTU/h*	18,000	21,000	24,000	21,000	24,000	26,000
Thermal efficiency	Up to 66.7%	Up to 78%	Up to 75%	Up to 80%		
Burner system	Natural Flame			Natural Flame		
AFUE Efficiency	Up to 63.8%	Up to 66%	Up to 72.8%	Up to 63.2%		
FE Ratings (Canada)	61.9% NG 72.6% LP	63% NG 67.7% LP	74.5% NG 84.2% LP	61.8%NG 55.7% LP	61.1% NG 60.7% LP	61.3%NG 60.8% LP
Dimensions (Actual)	32 7/8" W 31 3/4" H 15 7/8" D	37" W 34 5/8" H 15 7/8" D	41" W 34 5/8" H 15 7/8" D	33 1/8" W 37 7/8" H 14" D	37 1/8" W 41 1/2" H 16" D	41 1/8" W 41 1/2" H 16" D
Dimensions (Framing)	32 7/8" W 35 1/8" H 15 5/8" D	37 1/2" W 38 3/4" H 15 5/8" D	41 1/2" W 38 3/4" H 15 5/8" D	33 1/2" W 38" H x 13 3/4" D	37 1/2" W 41 5/8" H 15 3/4" D	41 1/2" W 41 5/8" H 15 3/4" D
<b>ACCESSORIES</b>						
Remotes	Optional	Optional	Optional	Optional		
Blower Kits	Optional	Optional	Optional	Optional		
Field Fuel Conversion Kit	Available	Available	Available	Available		

**CABINET DIMENSIONS**

PRODUCT	SURROUND	A	B	C	D	E	F	G	H	I	MAX ADJ OPENING	MIN ADJ OPENING	MAX FIREPLACE DEPTH
<b>STANDARD WALL CABINET MANTELS</b>													
400DVB	WSHGC32	57 3/4"	21"	49 3/4"	18"	39 1/4"	37 3/4"	35 7/8"	52 1/4"	5"	—	—	—
500DVB	WSHGC36	61 1/2"	22 1/4"	49 3/4"	19 3/4"	43 1/4"	41 3/4"	35 7/8"	56 1/4"	5"	—	—	—
<b>STANDARD CORNER CABINET MANTELS</b>													
400DVB	CSHGC32	62"	43 7/8"	35 5/8"	49 3/4"	39 1/4"	37 3/4"	35 7/8"	57 1/4"	5"	—	—	—
500DVB	CSHGC36	67 1/2"	47 3/4"	39 1/8"	49 3/4"	43 1/4"	41 3/4"	35 7/8"	63"	5"	—	—	—
<b>BARRINGTON CABINET</b>													
300DVB	BWC400	61 9/16"	18 1/4"	50 3/4"	34 3/8"	5"	47 5/8"	30"	—	—	35 1/2" W 32 3/4" H	32" W 29" H	14"
400DVB, 500DVB	BWC500	67 1/2"	22 1/4"	55"	—	—	—	—	—	—	42" W 37 3/8" H	36" W 33" H	18"

Gold indicates upgrade from previous model.

\*For natural gas models.

All Majestic direct vent fireplaces in this catalog are CSA design certified and available in both natural gas and LP configurations.



SOLITAIRE			CAMEO		PEARL		
33"	36"	42"	42"	47"	36" SPECIALTY		
BLDV300	BLDV400	BLDV500	500MDV	600MDV	STLDV, PFLDV, CLLDV, CRLDV		
Stylish finishing options from traditional to contemporary			Wide viewing area, increased warmth and multiple finishing options		3 different configurations for versatile style and installation options		
Signature Command®			Signature Command®		Signature Command®		
850	1,060	1,200	1,500	1,600	1,780		
Front, Clean Face			Front		See-Thru, Peninsula, Corner		
600	754	858	764	903	See Thru: 2,000	Peninsula: 2,771	Corner: 1,762
22,000	26,000	28,000	30,000	32,000	37,000		
Up to 80%			Up to 80%		Up to 80%		
Natural Flame			Natural Flame		—		
—	Up to 71%	Up to 68.1%	Up to 64%	—	67.01% NG 68.28% LP		
60.2% NG 64.2% LP	68.1% NG 62.8% LP	64.1% NG 67.9% LP	Up to 82%	Up to 78%	69.7% NG 79.4% LP		
34 1/2" W 37 3/4" H 15 1/16" D	37 1/16" W 40 3/4" H 17 1/16" D	41 1/16" W 41 3/4" H 17 1/16" D	41" W 46 5/16" H 22 5/16" D	47" W 46 5/16" H 22 5/16" D	See Thru: 44" W 40 5/16" H 23 3/4" D	Peninsula: 44" W 40 5/16" H 23 3/4" D	Corner: 44" W 40 5/16" H 23 3/4" D
34 7/8" W 38 7/8" H 15 1/8" D	37 7/16" W 41 3/4" H 17 1/16" D	41 7/16" W 41 3/4" H 17 1/16" D	42 1/16" W 46 1/2" H 20 3/8" D	48 1/16" W 46 1/2" H 20 3/8" D	See Thru: 50 1/16" W 48 3/16" H 23" D	Peninsula: 46 5/8" W 48 3/16" H 23" D	Corner: 46 5/8" W 48 3/16" H 23" D
Optional			Optional		Optional		
Optional			Optional		Optional		
Available			Available		Available		

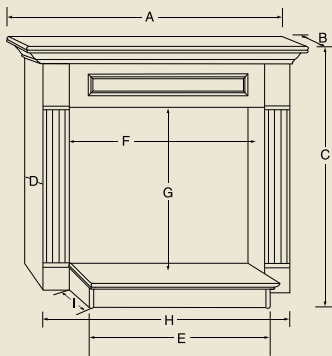

Standard Wall Cabinet Mantel  
400DVB, 500DVB

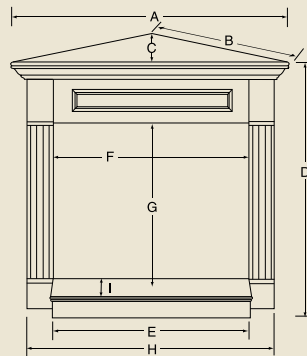

Standard Corner Cabinet Mantel  
400DVB, 500DVB

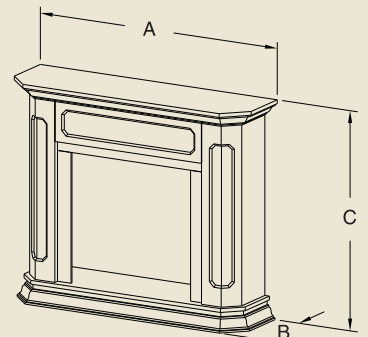

Barrington Cabinet  
300DVB, 400 DVB, 500DVB

# ULTIMATE CONVENIENCE AT YOUR FINGERTIPS

Majestic offers three control systems for our direct vent gas fireplaces.  
Discover the level of control that's right for you!

## EcoLogic® System

The EcoLogic® fireplace control system offers the benefits of an energy efficient intermittent pilot system, with the simplicity of a millivolt valve.

### Featuring:

- Electronic ignition — just flip the wall switch to enjoy your fireplace.
- Pilot selection option — choice of cold climate standing pilot or the energy efficient intermittent pilot
- Memory shut off remembers your favorite setting the next time the fireplace is turned on
- Convenient diagnostic code indication lights
- Built-in remote receiver for the option to easily add a remote control

## Signature Command® System

An A/C adaptor is included; however, unlike competing control systems that require A/C to function, the Signature Command® System can be installed where no power is available, making it more convenient than ever to enjoy the fire.

### Featuring:

- ON/OFF 3-step variable flame height adjustment
- Automatic, uninterrupted battery back-up during power outages
- Pilot selection option — choice of cold climate standing pilot or the energy efficient intermittent pilot
- Memory shut off remembers your favorite setting the next time the fireplace is turned on
- Convenient diagnostic code indication lights
- Built-in remote receiver for the option to easily add a remote control

## Total Signature Command® System

Enjoy the convenience of a technologically advanced and energy efficient fireplace control system! By adding a simple module you can have all the features below\*:

### Featuring:

All of the features included with Signature Command® System

### PLUS:

- Smart Mode® thermostat for enhanced energy efficiency — it automatically adjusts flame height and/or blower to maintain the desired temperature, using only the energy it needs to help save on fuel costs.
- TSFSC Full Function Touch Screen remote control
- Rear burner shut down feature lowers heat output as much as 70% for ambiance when heat is not needed (on select fireplaces)
- A/C accessory model for added control features, like household lighting, waterfall feature, and more!

Remotes and thermostats are available for all models for added convenience.



Touch screen hand held ON/OFF remote. A touch screen remote comes standard with Total Signature Command® models.



Thermostat ON/OFF remote control with 3-step flame height adjustment and 3-step blower control with receiver

\*if equipped with required accessories

Not all control systems available on all models.



YOUR STYLE. YOUR HOME. YOUR LIFE

A brand of Vermont Castings Group  
149 Cleveland Drive, Paris, Kentucky 40361  
majesticproducts.com

Your Majestic Dealer:

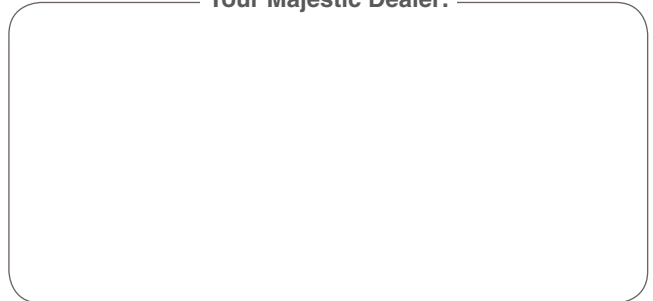

Warning: Hot glass will cause burns. Do not touch glass until cooled. Never allow children to touch glass.

FPO  
for FSC  
certification  
mark

To avoid personal injury or property damage, the product described by this brochure must be installed, operated and maintained in strict compliance with the instructions packaged with the product, and all applicable building or fire codes. Contact local building or fire officials about restrictions and installation inspection requirements. All photographs and drawings on this brochure are for illustrative purposes only and are not intended, nor should they be used as a substitute, for the instructions packaged with the unit. Appearance and specifications of the product are subject to change without notice. © 2015 Vermont Castings Group 1212MAJ Ver.03

For more information about Vermont Castings Group and Majestic efficient and environmentally friendly products, please visit majesticproducts.com